

EVALUATION KIT
AVAILABLE

MAXIM

3.4GHz to 3.8GHz SiGe Low-Noise Amplifier/PA Predriver

MAX2645

General Description

The MAX2645 is a versatile, high-linearity, low-noise amplifier designed for 3.4GHz to 3.8GHz wireless local loop (WLL), wireless broadband access, and digital microwave radio applications. The device features an externally adjustable bias control, set with a single resistor, that allows the user to meet minimum linearity requirements while minimizing current consumption. The amplifier's high-gain, low-noise performance and adjustable input third-order intercept (IP3) allow it to be used as a low-noise amplifier (LNA) in the receive path, a PA predriver in the transmit path, or as an LO buffer.

The MAX2645 features a logic-level gain control that provides a 25dB step reduction in gain, which improves IP3 performance for operation during high input signal level conditions. Supply current is reduced from 9mA in high-gain mode to 3mA in low-gain mode. The device also includes a logic-controlled shutdown mode, which reduces supply current to 0.1µA. The MAX2645 operates from a +3V to +5.5V supply and is offered in the miniature 10-pin µMAX package (5mm × 3mm) with an exposed paddle. Its performance has been optimized for use with the MAX2683/MAX2684 3.5GHz SiGe mixers to provide a complete high-performance, front-end solution for 3.5GHz applications.

Applications

Wireless Local Loop
Wireless Broadband Access
Digital Microwave Radios

Features

- ◆ 3.4GHz to 3.8GHz Frequency Range
- ◆ LNA Performance (High/Low-Gain Modes)
 - Gain: +14.4dB/-9.7dB
 - NF: 2.3dB/15.5dB
 - Input IP3: +4dBm/+13dBm
 - Supply Current: 9.2mA/2.7mA
- ◆ Highly Versatile Application
 - Receive Path 1st and 2nd Stage LNA
 - Transmit PA Predriver
 - LO Buffer
- ◆ Adjustable IP3 and Supply Current
- ◆ 0.1µA Supply Current in Shutdown Mode
- ◆ +3.0V to +5.5V Single-Supply Operation
- ◆ 10-Pin µMAX-EP Package (5.0mm x 3.0mm)

Ordering Information

| PART | TEMP RANGE | PIN-PACKAGE |
|------------|----------------|-------------|
| MAX2645EUB | -40°C to +85°C | 10 µMAX-EP* |

*EP = exposed paddle.

Pin Configuration appears at end of data sheet.

Typical Operating Circuit

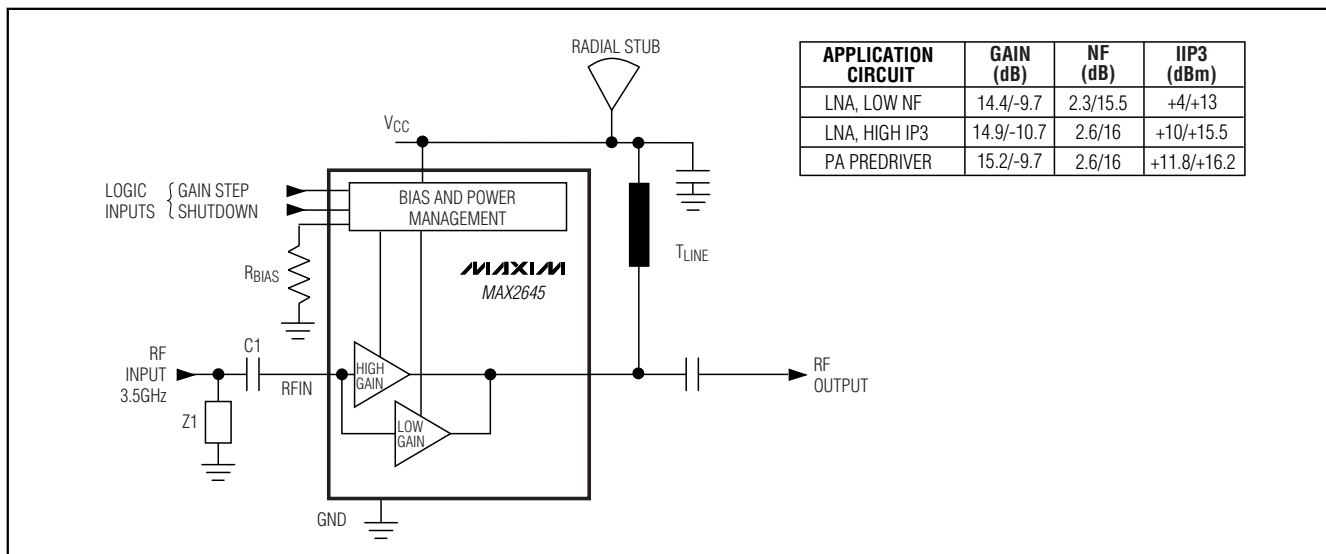

MAXIM

Maxim Integrated Products 1

For pricing, delivery, and ordering information, please contact Maxim/Dallas Direct! at 1-888-629-4642, or visit Maxim's website at www.maxim-ic.com.

3.4GHz to 3.8GHz SiGe Low-Noise Amplifier/PA Predriver

ABSOLUTE MAXIMUM RATINGS

| | | | |
|-------------------------------------------------------|----------------------------------|-----------------------------------|-----------------|
| V _{CC} to GND | -0.3V to +6.0V | Operating Temperature Range | -40°C to +85°C |
| GAIN, $\overline{\text{SHDN}}$, RFOUT to GND | 0.3V to (V _{CC} + 0.3V) | Junction Temperature | +150°C |
| RFIN Input Power (50Ω source) | 16dBm | Storage Temperature Range | -65°C to +150°C |
| Minimum R _{BIAS} | 10kΩ | Lead Temperature (soldering, 10s) | +300°C |
| Continuous Power Dissipation (T _A = +70°C) | | | |
| 10-Pin μMAX-EP | | | |
| (derate 10.3mW/°C above T _A = +70°C) | 825mW | | |

Stresses beyond those listed under "Absolute Maximum Ratings" may cause permanent damage to the device. These are stress ratings only, and functional operation of the device at these or any other conditions beyond those indicated in the operational sections of the specifications is not implied. Exposure to absolute maximum rating conditions for extended periods may affect device reliability.



CAUTION! ESD SENSITIVE DEVICE

DC ELECTRICAL CHARACTERISTICS

(V_{CC} = +3.0V to +5.5V, GAIN = $\overline{\text{SHDN}}$ = V_{CC}, R_{BIAS} = 20kΩ, no RF signals applied, T_A = -40°C to +85°C. Typical values are at V_{CC} = +3.3V, T_A = +25°C, unless otherwise indicated.) (Note 1)

| PARAMETER | CONDITIONS | | MIN | TYP | MAX | UNITS |
|--------------------------|--------------------------------------------------------------|------------------------|-----|-----|------|-------|
| Supply Voltage | | | 3.0 | | 5.5 | V |
| Operating Supply Current | R _{BIAS} = 20kΩ, T _A = +25°C | GAIN = V _{CC} | | 9.2 | 10.9 | mA |
| | | GAIN = GND | | 2.7 | 3.9 | |
| | R _{BIAS} = 20kΩ, T _A = -40°C to +85°C | GAIN = V _{CC} | | | 11.6 | |
| | | GAIN = GND | | | 4.0 | |
| | R _{BIAS} = 15kΩ, T _A = +25°C | GAIN = V _{CC} | | | 12 | |
| | | GAIN = GND | | | 3.6 | |
| Shutdown Supply Current | $\overline{\text{SHDN}}$ = GND | | | 0.1 | 2 | μA |
| Input Logic Voltage High | GAIN, $\overline{\text{SHDN}}$ | | 2.0 | | | V |
| Input Logic Voltage Low | GAIN, $\overline{\text{SHDN}}$ | | | | 0.6 | V |
| Input Logic Bias Current | GAIN = $\overline{\text{SHDN}}$ = V _{CC} | | | | 1 | μA |
| | GAIN = $\overline{\text{SHDN}}$ = GND | | -10 | | | |

3.4GHz to 3.8GHz SiGe Low-Noise Amplifier/PA Predriver

MAX2645

AC ELECTRICAL CHARACTERISTICS—LNA (Low-Noise Figure Application Circuit)

(MAX2645 EV kit, $V_{CC} = GAIN = \overline{SHDN} = +3.3V$, $R_{BIAS} = 20k\Omega \pm 1\%$, $P_{RFIN} = -20dBm$, $f_{RFIN} = 3550MHz$, $Z_o = 50\Omega$, $T_A = +25^\circ C$, unless otherwise noted.)

| PARAMETER | CONDITIONS | MIN | TYP | MAX | UNITS |
|---------------------------------|------------------------------------------------------------------------|-------|------------|-----------|---------|
| Frequency Range | (Note 2) | 3400 | | 3800 | MHz |
| Gain (Note 3) | GAIN = V_{CC} | 12.9 | 14.4 | 15.4 | dB |
| | GAIN = GND | -11.8 | -9.7 | -8.0 | |
| Gain Variation over Temperature | $T_A = -40^\circ C$ to $+85^\circ C$, GAIN = V_{CC} or GND (Note 4) | | ± 0.3 | ± 0.7 | dB |
| Gain Step | | | ± 24.1 | | dB |
| Input Third-Order Intercept | GAIN = V_{CC} (Note 5) | | +4 | | dBm |
| | GAIN = GND (Note 6) | | +13 | | |
| Input 1dB Compression Point | GAIN = V_{CC} | | -5 | | dBm |
| | GAIN = GND | | 0 | | |
| Noise Figure | GAIN = V_{CC} (Notes 4, 7) | | 2.3 | 3.0 | dB |
| | GAIN = GND | | 15.5 | | |
| Reverse Isolation | GAIN = V_{CC} | | 25 | | dB |
| | GAIN = GND | | 19 | | |
| Gain Step Transition Time | (Note 8) | | 1 | | μs |
| Turn-On/Turn-Off Time | (Note 9) | | 0.5 | | μs |

AC ELECTRICAL SPECIFICATIONS—LNA (High-Input IP3 Application Circuit)

(MAX2645 EV kit, $V_{CC} = GAIN = \overline{SHDN} = +3.3V$, $R_{BIAS} = 20k\Omega \pm 1\%$, $P_{RFIN} = -20dBm$, $f_{RFIN} = 3550MHz$, $Z_o = 50\Omega$, $T_A = +25^\circ C$, unless otherwise noted.)

| PARAMETER | CONDITIONS | MIN | TYP | MAX | UNITS |
|---------------------------------|---------------------------------------------------------------|------|-----------|------|-------|
| Frequency Range | (Note 2) | 3400 | | 3800 | MHz |
| Gain | GAIN = V_{CC} | | 14.9 | | dB |
| | GAIN = GND | | -10.7 | | |
| Gain Variation over Temperature | $T_A = -40^\circ C$ to $+85^\circ C$, GAIN = V_{CC} or GND | | ± 0.3 | | dB |
| Gain Step | | | 25.6 | | dB |
| Input Third-Order Intercept | GAIN = V_{CC} (Note 6) | | +10.0 | | dBm |
| | GAIN = GND (Note 7) | | +15.5 | | |
| Input 1dB Compression Point | GAIN = V_{CC} | | -4 | | dBm |
| | GAIN = GND | | 0 | | |
| Noise Figure | GAIN = V_{CC} | | 2.6 | | dB |
| | GAIN = GND | | 16 | | |
| Reverse Isolation | GAIN = V_{CC} | | 25 | | dB |
| | GAIN = GND | | 19 | | |

3.4GHz to 3.8GHz SiGe Low-Noise Amplifier/PA Predriver

AC ELECTRICAL SPECIFICATIONS—PA Predriver Application Circuit

(MAX2645 EV kit, $V_{CC} = \overline{\text{SHDN}} = +3.3\text{V}$, $R_{\text{BIAS}} = 20\text{k}\Omega \pm 1\%$, $P_{\text{RFIN}} = -20\text{dBm}$, $f_{\text{RFIN}} = 3550\text{MHz}$, $Z_o = 50\Omega$, $T_A = +25^\circ\text{C}$, unless otherwise noted.)

| PARAMETER | CONDITIONS | MIN | TYP | MAX | UNITS |
|---------------------------------|---------------------------------------------------------------------------|------|-----------|------|-------|
| Frequency Range | (Note 2) | 3400 | | 3800 | MHz |
| Gain | GAIN = V_{CC} | | 15.2 | | dB |
| | GAIN = GND | | -9.7 | | |
| Gain Variation over Temperature | $T_A = -40^\circ\text{C}$ to $+85^\circ\text{C}$, GAIN = V_{CC} or GND | | ± 0.3 | | dB |
| Gain Step | | | 24.9 | | dB |
| Input Third-Order Intercept | GAIN = V_{CC} (Note 6) | | +11.8 | | dBm |
| | GAIN = GND (Note 7) | | +16.2 | | |
| Input 1dB Compression Point | GAIN = V_{CC} | | -1.8 | | dBm |
| | GAIN = GND | | 0 | | |
| Noise Figure | GAIN = V_{CC} | | 2.6 | | dB |
| | GAIN = GND | | 16 | | |
| Reverse Isolation | GAIN = V_{CC} | | 25 | | dB |
| | GAIN = GND | | 19 | | |

Note 1: Limits over temperature guaranteed by correlation to worst-case temperature testing.

Note 2: This is the recommended operating frequency range. Operation outside this frequency range is possible but has not been characterized. The device is characterized and tested at 3550MHz. For optimum performance at a given frequency, the output matching network must be properly designed. See *Applications Information* section.

Note 3: Specifications are corrected for board losses (0.25dB at input, 0.25dB at output).

Note 4: Guaranteed by design and characterization.

Note 5: Input IP3 measured with two tones, $f_1 = 3550\text{MHz}$ and $f_2 = 3551\text{MHz}$, at -20dBm per tone.

Note 6: Input IP3 measured with two tones, $f_1 = 3550\text{MHz}$ and $f_2 = 3551\text{MHz}$, at -12dBm per tone.

Note 7: Specifications are corrected for board losses (0.25dB at input).

Note 8: Time from when GAIN changes state to when output power reaches 1dB of its final value.

Note 9: Time from when $\overline{\text{SHDN}}$ changes state to when output power reaches 1dB of its final value.

Typical Operating Characteristics

(MAX2645 EV kit, $V_{CC} = +3.3\text{V}$, $R_{\text{BIAS}} = 20\text{k}\Omega$, $f_{\text{RFIN}} = 3550\text{MHz}$, $T_A = +25^\circ\text{C}$, unless otherwise noted.)

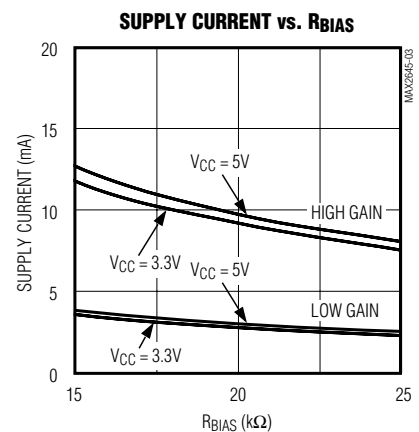
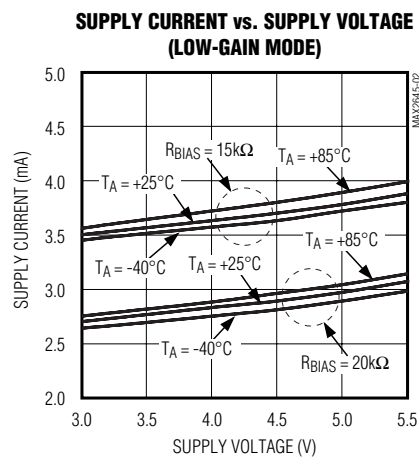
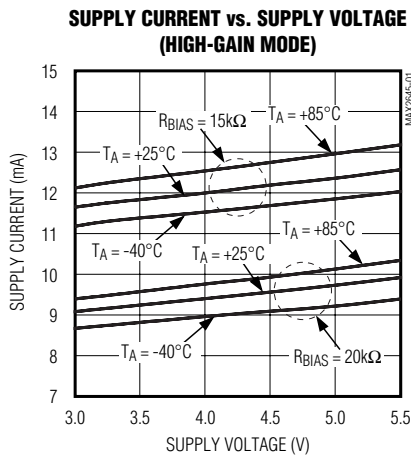

3.4GHz to 3.8GHz SiGe Low-Noise Amplifier/PA Predriver

MAX2645

Typical Operating Characteristics (continued)

(MAX2645 EV kit, $V_{CC} = +3.3V$, $R_{BIAS} = 20k\Omega$, $f_{RFIN} = 3550MHz$, $T_A = +25^\circ C$, unless otherwise noted.)

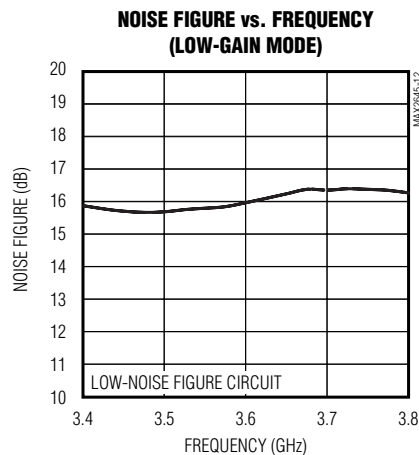
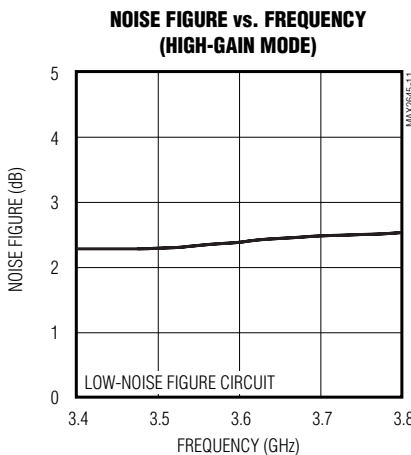
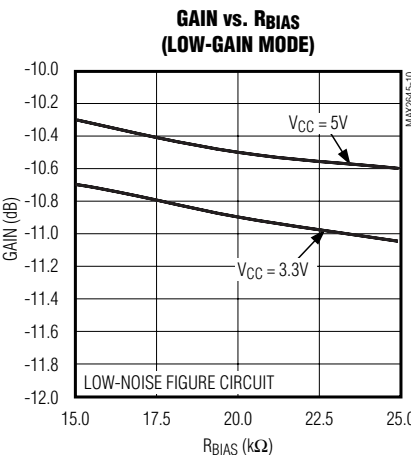
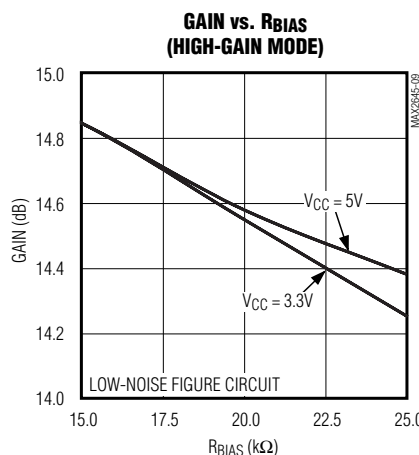
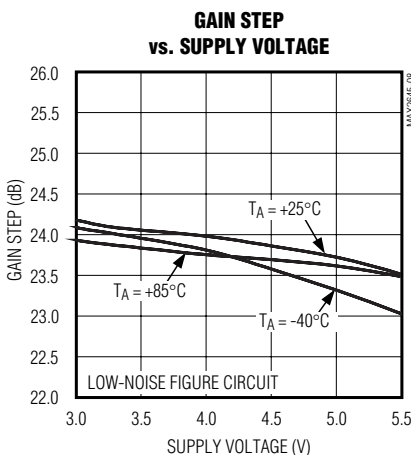
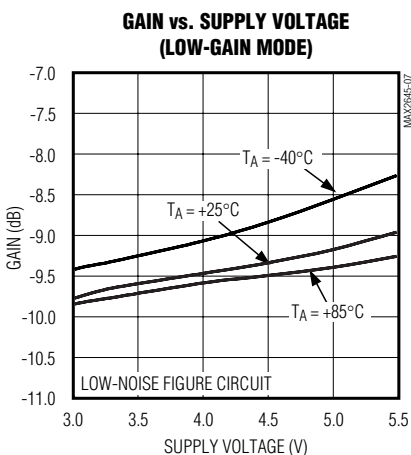
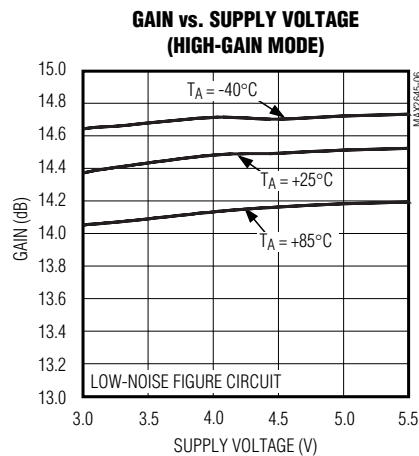
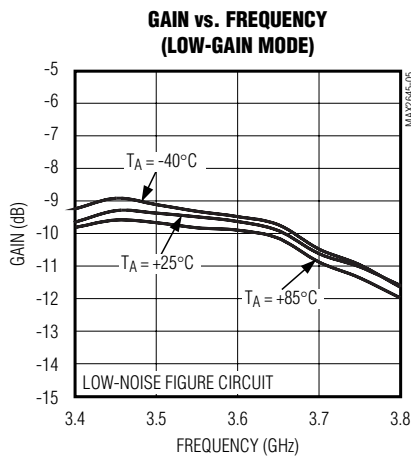
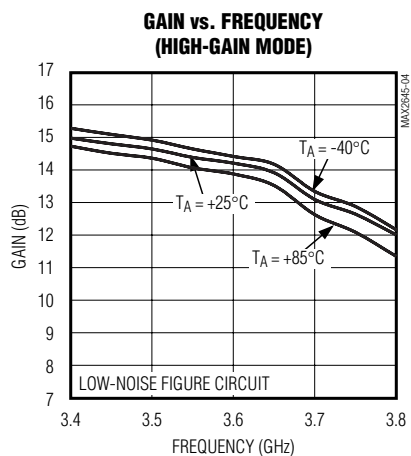

3.4GHz to 3.8GHz SiGe Low-Noise Amplifier/PA Predriver

Typical Operating Characteristics (continued)

(MAX2645 EV kit, $V_{CC} = +3.3V$, $R_{BIAS} = 20k\Omega$, $f_{RFIN} = 3550MHz$, $T_A = +25^\circ C$, unless otherwise noted.)

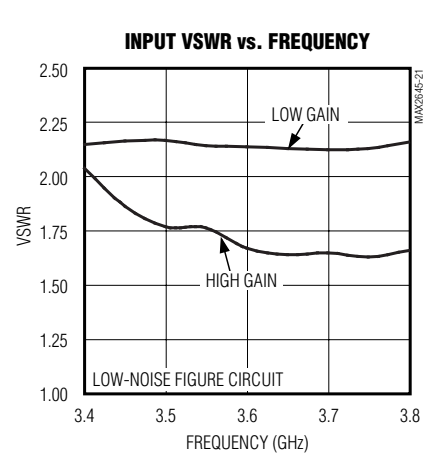
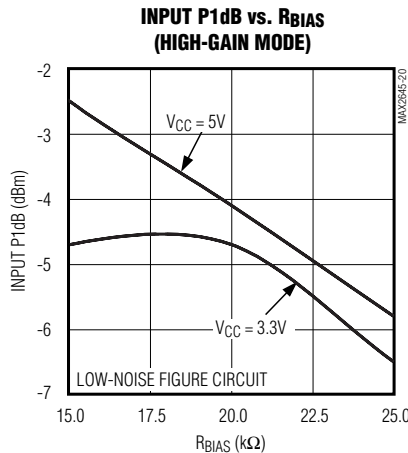
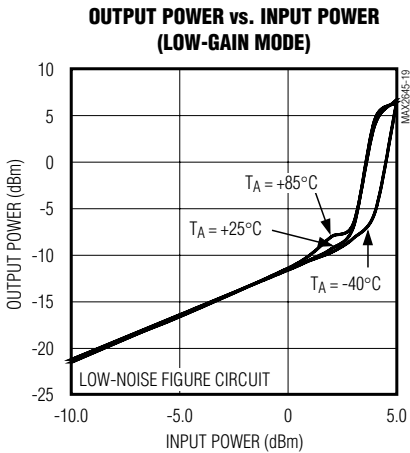
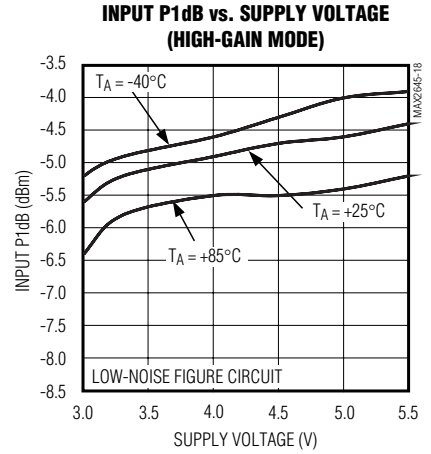
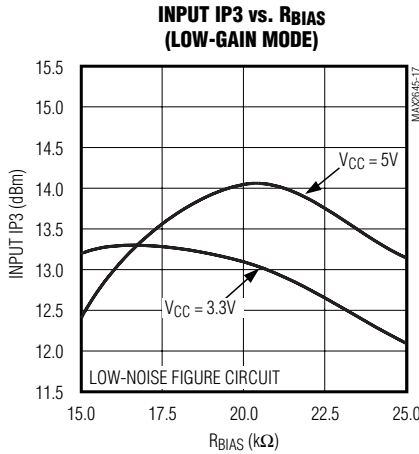
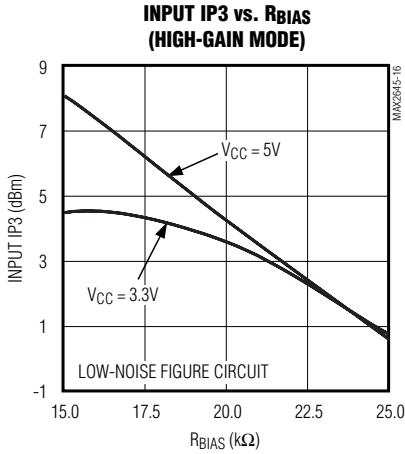
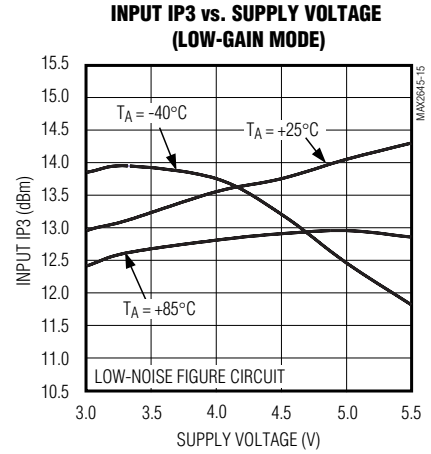
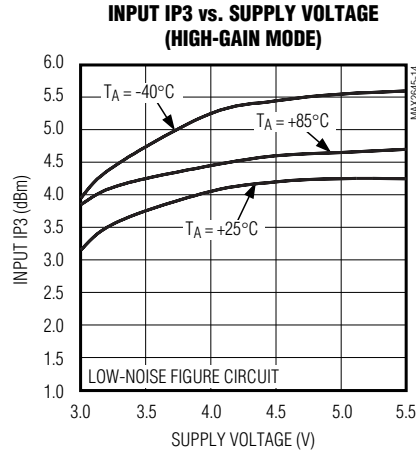
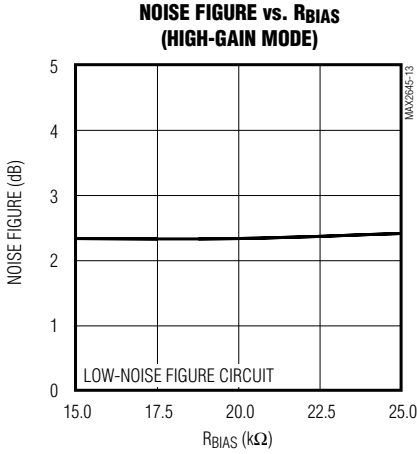

3.4GHz to 3.8GHz SiGe Low-Noise Amplifier/PA Predriver

MAX2645

Typical Operating Characteristics (continued)

(MAX2645 EV kit, $V_{CC} = +3.3V$, $R_{BIAS} = 20k\Omega$, $f_{RFIN} = 3550MHz$, $T_A = +25^\circ C$, unless otherwise noted.)

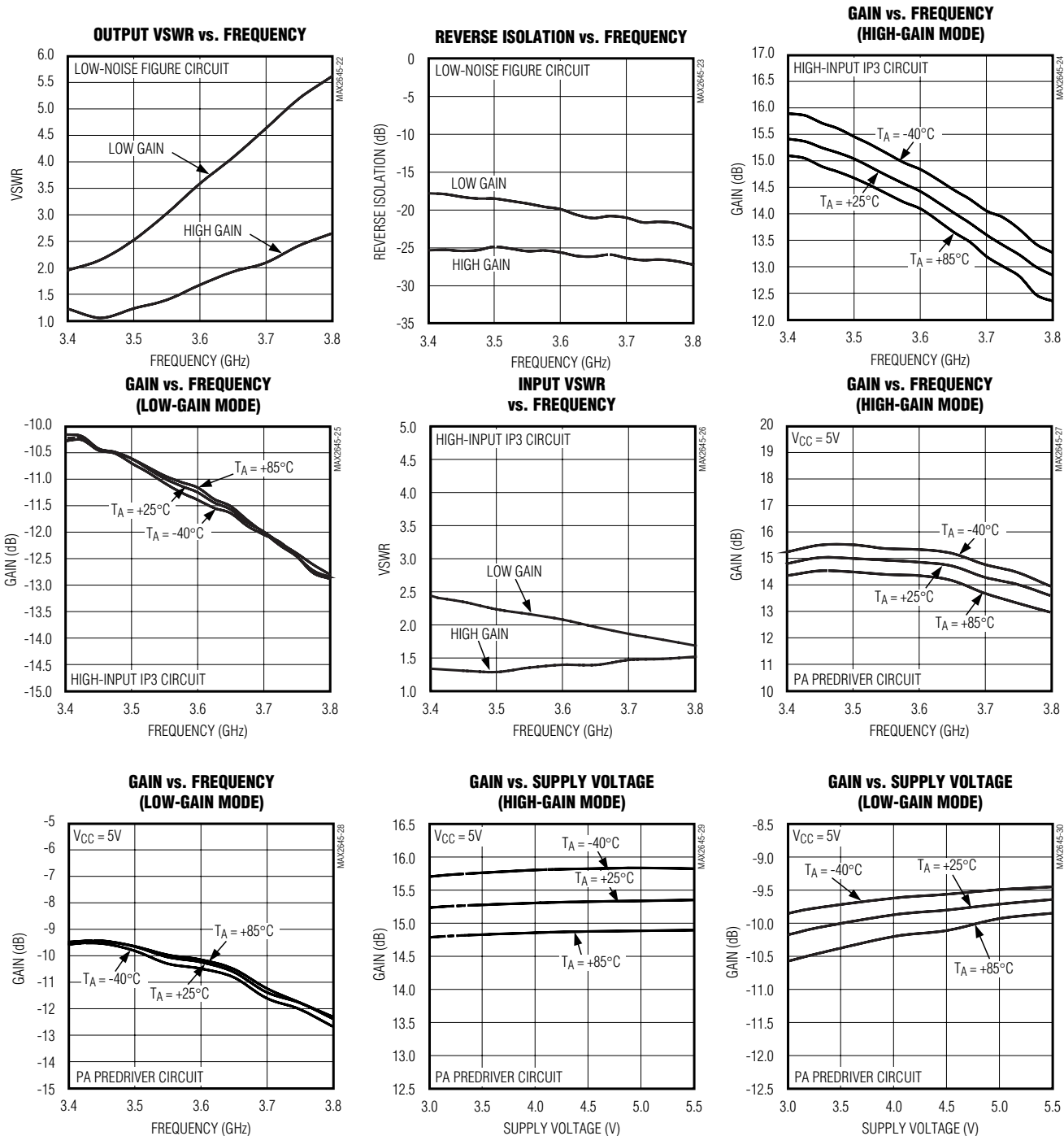

3.4GHz to 3.8GHz SiGe Low-Noise Amplifier/PA Predriver

Typical Operating Characteristics (continued)

(MAX2645 EV kit, $V_{CC} = +3.3V$, $R_{BIAS} = 20k\Omega$, $f_{RFIN} = 3550MHz$, $T_A = +25^\circ C$, unless otherwise noted.)

**OUTPUT P1dB POINT vs. SUPPLY VOLTAGE
(HIGH-GAIN MODE)**

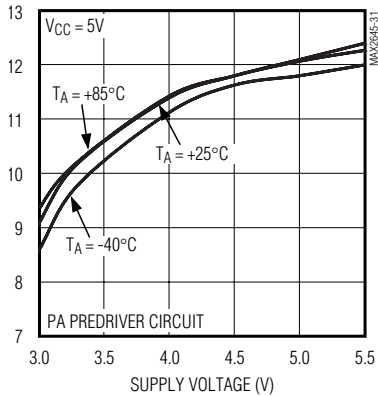

**OUTPUT POWER vs. INPUT POWER
(LOW-GAIN MODE)**

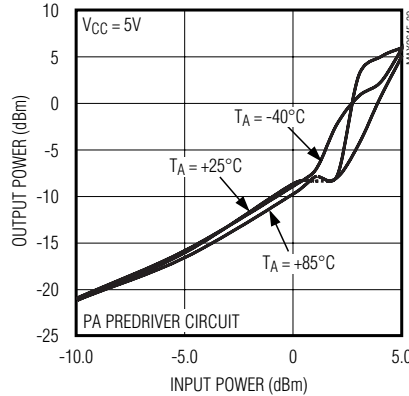

INPUT VSWR vs. FREQUENCY

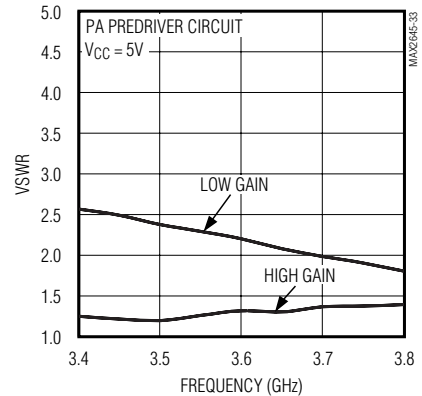

Pin Description

| PIN | NAME | FUNCTION |
|----------------|-------------------|-------------------------------------------------------------------------------------------------------------------------------------------------------------------------------------------|
| 1, 2, 4, 7, EP | GND | Ground. Connect to ground plane with a low-inductance connection. Solder exposed paddle evenly to the board ground plane. |
| 3 | RFIN | RF Input Port to Amplifier. Requires a matching network and a DC-blocking capacitor that may be part of this network. See Figure 1 for recommended component values. |
| 5 | BIAS | Bias-Setting Resistor Connection. A resistor, R_{BIAS} , placed from BIAS to ground sets the linearity and supply current of the amplifier. |
| 6 | RFOUT | RF Open-Collector Output Port of Amplifier. Requires a matching network composed of an inductance to V_{CC} and a DC-blocking capacitor. See Figure 1 for recommended component values. |
| 8 | \overline{SHDN} | Shutdown Control Logic-Level Input. A logic high enables the device for normal operation. A logic low places the device in low-power shutdown mode. |
| 9 | GAIN | Gain Control Logic-Level Input. A logic high places the device in high-gain mode. A logic low places the device in low-gain mode, reducing the gain by 25dB. |
| 10 | V_{CC} | Power Supply Input. Bypass directly to ground with a capacitor as close to the supply pin as possible. See Figure 1 for recommended component values. |

3.4GHz to 3.8GHz SiGe Low-Noise Amplifier/PA Predriver

MAX2645

Detailed Description

The MAX2645 is a versatile amplifier with high-gain, high-linearity, and low-noise performance—features that make it suitable for use as an LNA, high-linearity/low-noise amplifier, PA predriver, or LO buffer in the 3.4GHz to 3.8GHz frequency range. See Figure 1, MAX2645 *Typical Application Circuit*, for recommended component values. A single external bias-setting resistor allows the system designer to trade off linearity for reduced supply current. A logic-level control reduces gain by a 25dB step to further improve input IP3 performance. A low-power shutdown mode disables the device and reduces current consumption to 0.1μA.

Bias Circuitry

The linearity and supply current of the MAX2645 are externally programmable with a single resistor (R_{BIAS}) placed from BIAS to GND. Larger resistor values result in lower IP3 performance and lower supply current, while smaller resistor values result in higher IP3 performance and higher supply current. Use resistor values in the 15kΩ to 25kΩ range, with a nominal value of 20kΩ suitable for most applications. See *Typical Operating Characteristics* for performance variation vs. R_{BIAS} value.

Gain Step Control

The MAX2645 features a logic-level gain step control input (GAIN) that places the device in high-gain or low-gain mode. A logic-level high places the device in high-gain mode, where the gain is 14.5dB. A logic-level low places the device in low-gain/high-linearity mode, where the gain is reduced to 10dB and the input IP3 performance is increased.

Shutdown Control

The MAX2645 features a logic-level shutdown control input. A logic high on $\overline{\text{SHDN}}$ enables the device for normal operation. A logic low on $\overline{\text{SHDN}}$ disables all device functions and reduces supply current to 0.1μA.

Applications Information

RF Input

The RFIN port is internally biased and requires an external DC-blocking capacitor. A matching network is required for best performance. Figure 1 shows component values optimized for best noise-figure performance, low-noise figure, high-input IP3 performance, and high-output P1dB performance in the 3.4GHz to 3.8GHz frequency range. For matching to other frequencies, see Tables 1 and 2.

Table 1. MAX2645 S-Parameters

| FREQ (MHz) | S11 | | S21 | | S12 | | S22 | |
|-------------------------------------------------------------------------------|-------|--------|-------|-------|-------|-------|-------|-------|
| | MAG | PHASE | MAG | PHASE | MAG | PHASE | MAG | PHASE |
| R_{BIAS} = 20kΩ, V_{CC} = +3.3V, T_A = +25°C | | | | | | | | |
| 3400 | 0.468 | -149.8 | 5.061 | -44.6 | 0.053 | -55.5 | 0.660 | -57.0 |
| 3450 | 0.466 | -150.4 | 4.975 | -46.3 | 0.058 | -60.8 | 0.658 | -58.4 |
| 3500 | 0.472 | -151.6 | 5.098 | -49.9 | 0.056 | -64.6 | 0.661 | -60.6 |
| 3550 | 0.469 | -153.4 | 4.883 | -53.7 | 0.054 | -62.7 | 0.658 | -63.0 |
| 3600 | 0.471 | -154.6 | 4.814 | -53.7 | 0.056 | -64.4 | 0.647 | -64.2 |
| 3650 | 0.477 | -155.0 | 5.118 | -57.4 | 0.058 | -68.9 | 0.657 | -66.2 |
| 3700 | 0.485 | -156.6 | 4.769 | -63.4 | 0.054 | -70.5 | 0.657 | -69.8 |
| 3750 | 0.484 | -156.5 | 4.780 | -62.3 | 0.058 | -72.0 | 0.654 | -70.9 |
| 3800 | 0.492 | -157.0 | 4.939 | -66.6 | 0.060 | -75.4 | 0.654 | -72.3 |
| R_{BIAS} = 15kΩ, V_{CC} = +5V, T_A = +25°C | | | | | | | | |
| 3400 | 0.454 | -146.6 | 5.350 | -41.8 | 0.057 | -51.3 | 0.651 | -52.3 |
| 3450 | 0.457 | -147.4 | 5.245 | -43.5 | 0.061 | -56.7 | 0.646 | -53.7 |
| 3500 | 0.465 | -147.9 | 5.375 | -46.6 | 0.060 | -61.2 | 0.654 | -55.6 |
| 3550 | 0.468 | -149.7 | 5.165 | -50.3 | 0.057 | -61.0 | 0.652 | -58.3 |
| 3600 | 0.472 | -150.5 | 5.066 | -50.2 | 0.060 | -62.7 | 0.645 | -59.3 |
| 3650 | 0.481 | -150.5 | 5.386 | -53.4 | 0.063 | -67.6 | 0.652 | -60.7 |
| 3700 | 0.486 | -152.2 | 5.040 | -59.4 | 0.060 | -67.8 | 0.648 | -63.9 |
| 3750 | 0.486 | -152.4 | 5.019 | -58.3 | 0.062 | -67.0 | 0.642 | -64.8 |
| 3800 | 0.499 | -152.6 | 5.207 | -62.0 | 0.065 | -73.3 | 0.643 | -66.2 |

3.4GHz to 3.8GHz SiGe Low-Noise Amplifier/PA Predriver

Table 2. MAX2645 Noise Parameters

| FREQUENCY (MHz) | F _{MIN} (dB) | Γ_{opt} | Γ_{opt} ANGLE | R _N (Ω) |
|-------------------------------------------------------------------------------------------------|-----------------------|----------------|----------------------|-----------------------------|
| R_{BIAS} = 20kΩ, V_{CC} = +3.3V, T_A = +25°C | | | | |
| 3400 | 2.098 | 0.237 | 144.1 | 31.1 |
| 3450 | 2.122 | 0.235 | 146.1 | 31.5 |
| 3500 | 2.148 | 0.235 | 148.2 | 32.0 |
| 3550 | 2.173 | 0.234 | 150.3 | 32.5 |
| 3600 | 2.198 | 0.233 | 152.4 | 32.9 |
| 3650 | 2.225 | 0.232 | 154.5 | 33.5 |
| 3700 | 2.251 | 0.231 | 156.5 | 33.9 |
| 3750 | 2.279 | 0.230 | 158.6 | 34.5 |
| 3800 | 2.306 | 0.229 | 160.7 | 35.0 |
| R_{BIAS} = 15kΩ, V_{CC} = +5V, T_A = +25°C | | | | |
| 3400 | 2.103 | 0.210 | 146.3 | 31.1 |
| 3450 | 2.127 | 0.209 | 148.4 | 31.6 |
| 3500 | 2.152 | 0.208 | 150.5 | 32.1 |
| 3550 | 2.177 | 0.207 | 152.6 | 32.5 |
| 3600 | 2.203 | 0.206 | 154.7 | 33.0 |
| 3650 | 2.229 | 0.206 | 156.8 | 33.5 |
| 3700 | 2.256 | 0.205 | 158.9 | 34.0 |
| 3750 | 2.282 | 0.204 | 161.0 | 34.6 |
| 3800 | 2.310 | 0.204 | 163.1 | 35.1 |

RF Output

The RFOUT port is an open-collector output that must be tied to VCC through an inductance for proper biasing. The MAX2645 EV kit uses a length of transmission line equivalent to 1.5nH of inductance. A DC-blocking capacitor is required and can be part of the output matching network. See Figure 1 for component values recommended for operation over the 3.4GHz to 3.8GHz frequency range. See Table 1 for matching to other frequencies. This transmission line is terminated at the VCC node with a radial stub for high-frequency bypassing. This arrangement provides a high-Q, low-loss bias network used to optimize performance. The radial stub can be replaced with an appropriate microwave capacitor.

Power-Supply, Bias Circuitry, and Logic-Input Bypassing

Proper power-supply bypassing is essential for high-frequency circuit stability. Bypass VCC with 10 μ F, 0.1 μ F, and 50pF capacitors located as close to the VCC pin as possible.

To minimize the amount of noise injected into the bias circuitry and logic inputs, bypass the pins with capacitors located as near to the device pin as possible. For additional isolation on the logic-control pins, place resistors between the logic-control inputs and the bypass capacitors. See Figure 1 for recommended component values; refer to MAX2645 EV kit manual for recommended board layout.

Layout Considerations

A properly designed PC board is an essential part of any RF/microwave circuit. Keep RF signal lines as short as possible to reduce losses, radiation, and inductance. Use separate, low-inductance vias to the ground plane for each ground pin. For best performance, solder the exposed paddle on the bottom of the device package evenly to the board ground plane.

3.4GHz to 3.8GHz SiGe Low-Noise Amplifier/PA Predriver

MAX2645

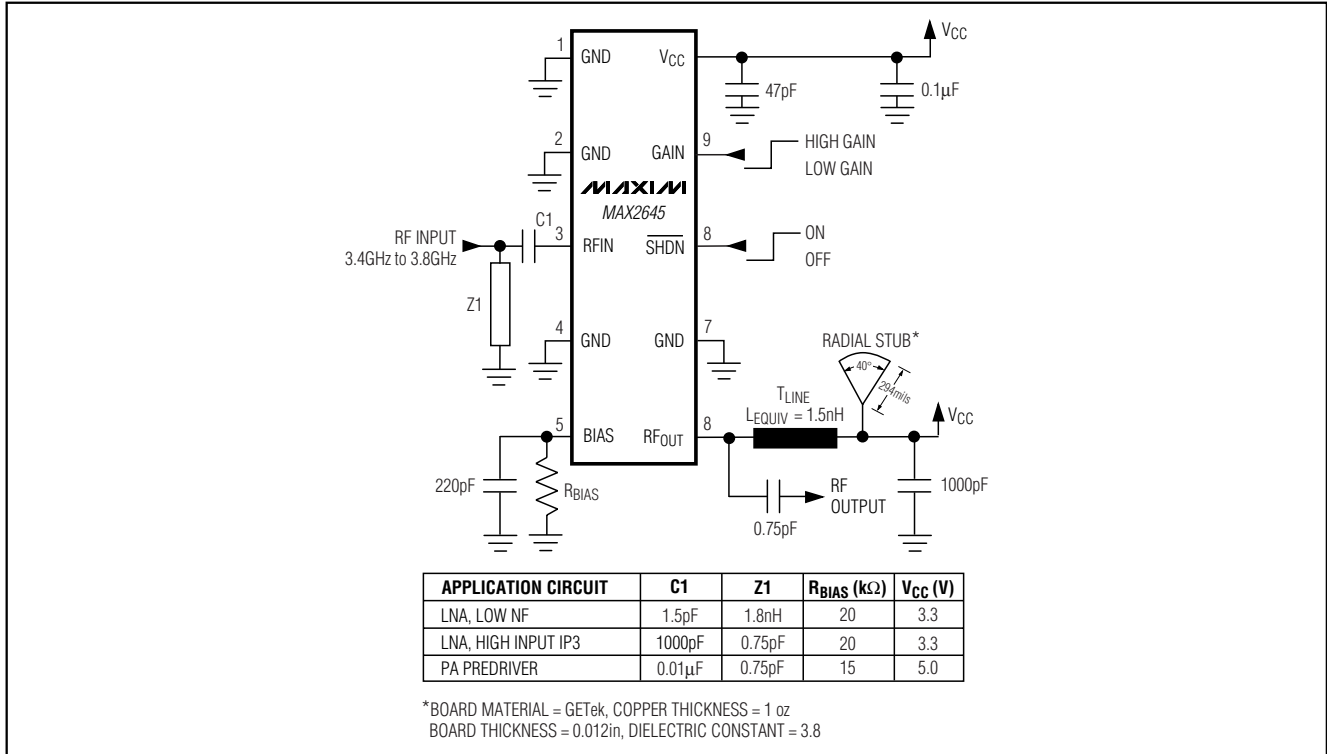

Figure 1. Typical Application Circuit

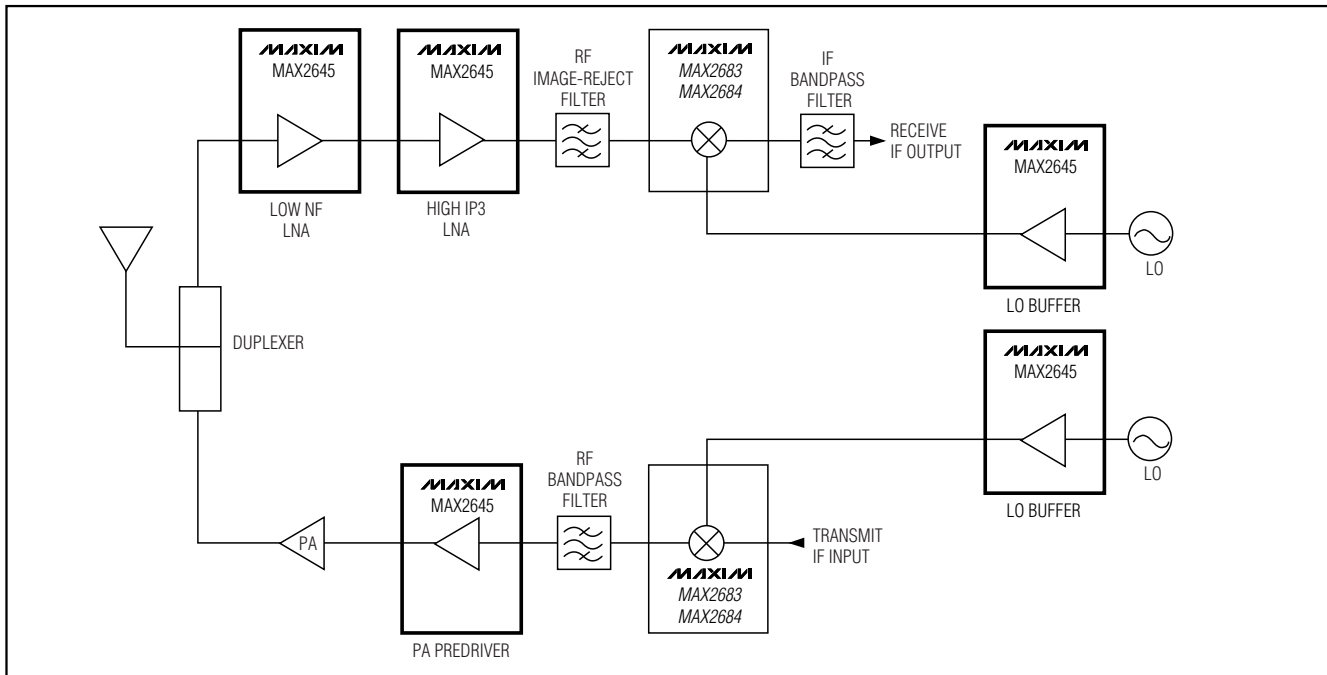

Figure 2. Typical System Application Block Diagram

3.4GHz to 3.8GHz SiGe Low-Noise Amplifier/PA Predriver

Pin Configuration

Chip Information

TRANSISTOR COUNT: 271

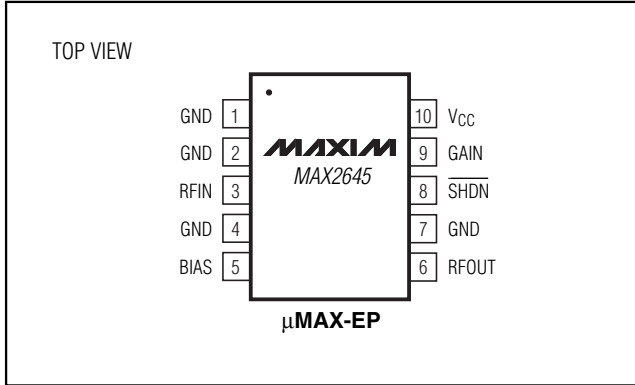

Package Information

(The package drawing(s) in this data sheet may not reflect the most current specifications. For the latest package outline information go to www.maxim-ic.com/packages.)

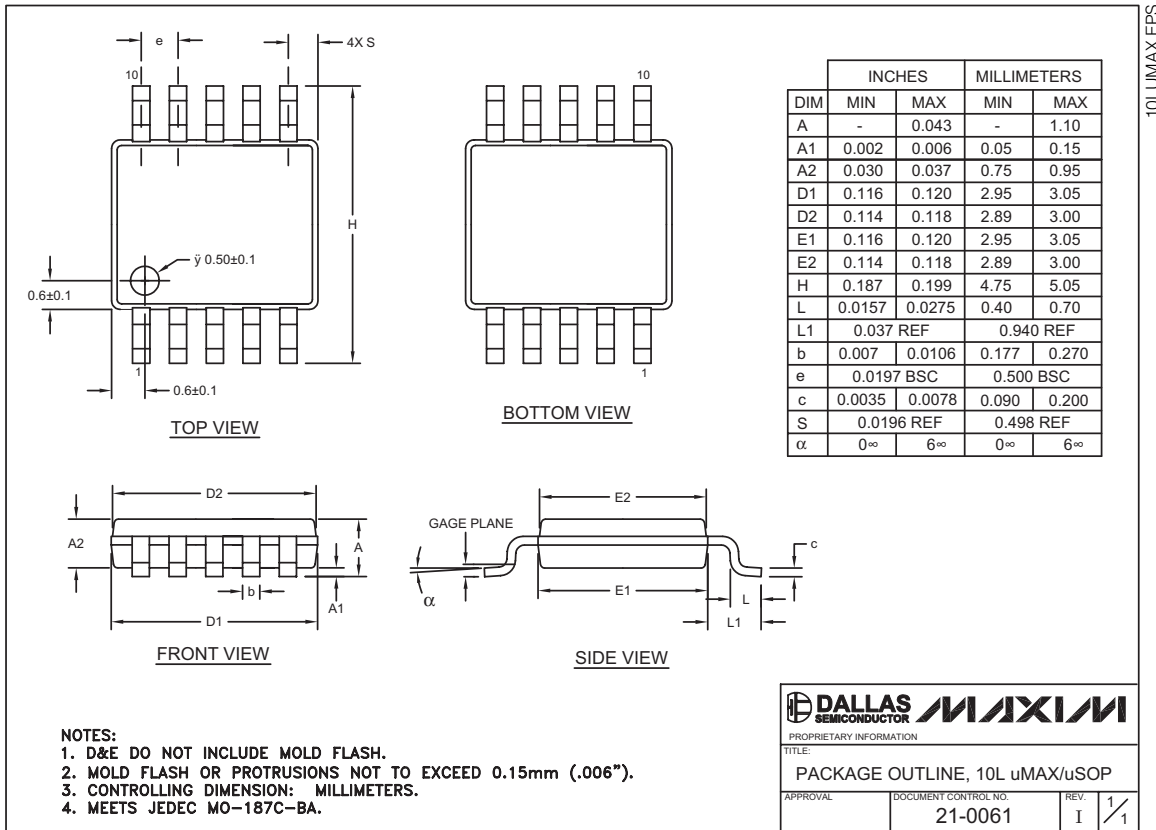

Maxim cannot assume responsibility for use of any circuitry other than circuitry entirely embodied in a Maxim product. No circuit patent licenses are implied. Maxim reserves the right to change the circuitry and specifications without notice at any time.

12 **Maxim Integrated Products, 120 San Gabriel Drive, Sunnyvale, CA 94086 408-737-7600**

Mouser Electronics

Authorized Distributor

Click to View Pricing, Inventory, Delivery & Lifecycle Information:

[Analog Devices Inc.:](#)

[MAX2645EUB+](#) [MAX2645EUB+T](#)