

MAX16909 Evaluation Kit

Evaluates: MAX16909

General Description

The MAX16909 evaluation kit (EV kit) demonstrates the MAX16909 3A, current-mode step-down converter with an integrated high-side switch. The EV kit operates over a wide 3.5V to 36V input voltage range. The EV kit has a switching frequency of 400kHz and a voltage output of 1.8V at 3A.

Features

- ◆ Wide 3.5V to 36V Input Supply Range
- ◆ Pin-Programmable Adjustable Output Voltage
- ◆ Adjustable Switching Frequency (400kHz Default)
- ◆ Proven PCB Layout
- ◆ Fully Assembled and Tested

[Ordering Information](#) appears at end of data sheet.

Component List

DESIGNATION	QTY	DESCRIPTION
C1	1	47 μ F \pm 20%, 50V aluminum electrolytic capacitor (8mm x 10.20mm) Panasonic EEE-TG1H470UP
C2, C4	2	4.7 μ F \pm 10%, 50V X7R ceramic capacitors (1210) Murata GRM32ER71H475KA55L
C3, C5	2	0.1 μ F \pm 10%, 50V X7R ceramic capacitors (0603) Murata GRM188R71H104KA57D
C6	1	0.1 μ F \pm 10%, 16V X7R ceramic capacitor (0402) Murata GRM155R71C104K
C7, C8	2	47 μ F \pm 20%, 6.3V X7R ceramic capacitors (1210) Murata GCM32ER70J476ME19L
C10	1	1 μ F \pm 10%, 10V X7R ceramic capacitor (0402) TDK C1005X5R1A105K
C12	1	2700pF \pm 10%, 50V X7R ceramic capacitor (0402) Murata GRM155R71H272KA
C13	1	12pF \pm 5%, 50V C0G ceramic capacitor (0402) Murata GRM1555C1H120J
C14, C15	0	Not installed, ceramic capacitors (0402)

DESIGNATION	QTY	DESCRIPTION
D1	1	3A, 60V Schottky diode (SMB) Diodes Inc. B360B-13-F
EXT_SUP, EXT_VBAT, FSYNC, OUT, POWERGOOD	5	Red test points
GND	4	Black test points
JU1	1	3-pin header
L1	1	10 μ H, 3.5A inductor (7mm x 6.9mm) Würth 744314101
LX	0	Not installed, red test point
R1, R9	2	20k Ω \pm 1% resistors (0402)
R2	1	61.9k Ω \pm 1% resistor (0402)
R3	1	10k Ω \pm 5% resistor (0402)
R4	1	80.6k Ω \pm 1% resistor (0402)
R6	1	100k Ω \pm 1% resistor (0402)
R7, R12	0	Not installed, resistors (0402)
R8	1	0 Ω \pm 5% resistor (1210)
R10	1	0 Ω \pm 5% resistor (0402)
U1	1	Automotive step-down converter (16 TSSOP-EP) MAX16909RAUE/V+
—	1	Shunt Kycon SX1100-B
—	1	PCB: MAX16909 EVALUATION KIT

MAX16909 Evaluation Kit

Evaluates: MAX16909

Component Suppliers

SUPPLIER	PHONE	WEBSITE
Diodes Incorporated	805-446-4800	www.diodes.com
Murata Electronics North America, Inc.	770-436-1300	www.murata-northamerica.com
Panasonic Corp.	800-344-2112	www.panasonic.com
TDK Corp.	948-803-6100	www.component.tdk.com
Würth Elektronik GmbH & Co. KG	201-785-8800	www.we-online.com

Note: Indicate that you are using the MAX16909 when contacting these component suppliers.

Table 1. EN Configuration (JU1)

SHUNT POSITION	DESCRIPTION
1-2*	Connects the device's EN pin to the voltage at VSUP for normal operation.
2-3	Connects the device's EN pin to GND to enter shutdown mode.

*Default position.

Quick Start

Required Equipment

- MAX16909 EV kit
- 3.5V to 36V, 3A DC power supply
- Electronic load capable of 3A
- Digital voltmeter (DVM)

Procedure

The EV kit is fully assembled and tested. Follow the steps below to verify board operation. **Caution: Do not turn on supplies until all connections are completed.**

- 1) Verify that jumper JU1 is in the default position, as shown in Table 1.
- 2) Connect the power supply between the EXT_VBAT and nearest GND test points.
- 3) Connect the 3A electronic load between the OUT and nearest GND test points.
- 4) Connect the DVM between the OUT and nearest GND test points.
- 5) Turn on the power supply.
- 6) Enable the electronic load.
- 7) Verify that the voltage at the OUT test point is 1.8V.

Detailed Description of Hardware

The MAX16909 EV kit demonstrates the MAX16909 wide input voltage range, high-frequency, step-down converter. The EV kit operates over a wide 3.5V to 36V input voltage range. The output voltage is set for 1.8V at 3A, but can be adjusted from 1V to 10V.

Enable (EN)

Place a shunt in the 1-2 position on jumper JU1 for normal operation. To place the device into shutdown mode, move the shunt on JU1 to the 2-3 position.

Output

The default output of the EV kit is set at 1.8V. To adjust the output voltage (V_{OUT}), change resistors R4 and R6 appropriately using the following formula:

$$R4 = R6 \left[\left(\frac{V_{OUT}}{V_{FB}} \right) - 1 \right]$$

where $V_{FB} = 1V$.

To set the output to a fixed 5V, connect FB to BIAS by removing resistors R4, R6, and R10, and placing a 0Ω resistor on R12.

Synchronization Input (FSYNC)

The EV kit uses resistor R9 to connect the FSYNC pin to ground, which sets the switching frequency to the internal clock.

An external logic-level clock can also connect to the provided FSYNC test point to synchronize the device. The external signal frequency must be 10% higher than the internal clock frequency for proper operation.

Setting the Switching Frequency (FOSC)

The EV kit switching frequency is set by resistor R2, connected from FOSC to GND. The switching frequency can be configured by selecting an appropriate value for R2. Use the following equation to select R2:

$$R2 \sim \frac{26.4 \times 10^9 \Omega / s}{f_{SW}}$$

where f_{SW} is the desired switching frequency in hertz. The adjustment range for f_{SW} is 220kHz to 1MHz.

Refer to *Figure 2. Switching Frequency vs. R_{FOSC}* in the MAX16909 IC data sheet for a graphical approach of selecting the correct R_{FOSC} (R2) value for the desired switching frequency.

MAX16909 Evaluation Kit

Evaluates: MAX16909

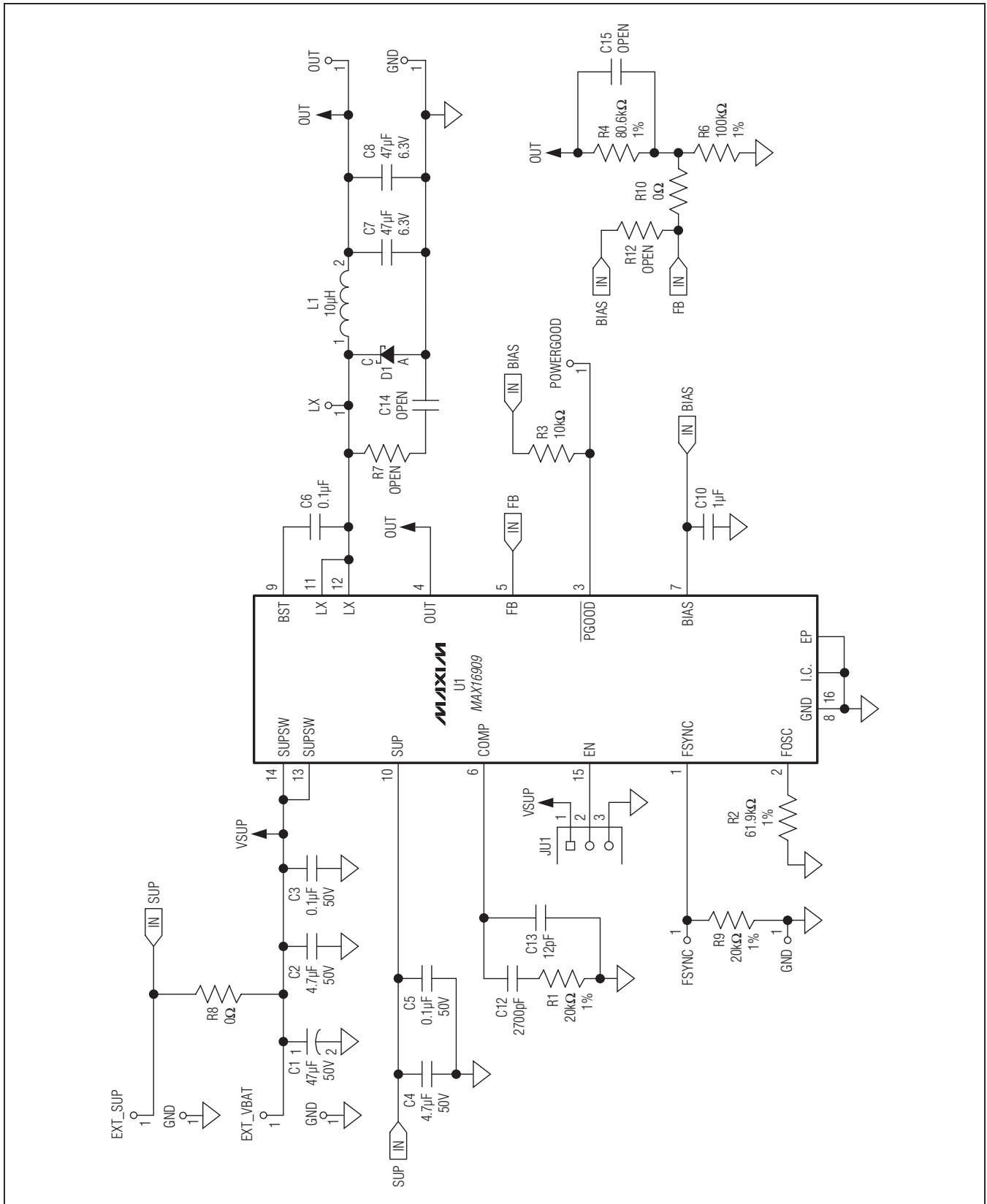

Figure 1. MAX16909 EV Kit Schematic

MAX16909 Evaluation Kit

Evaluates: MAX16909

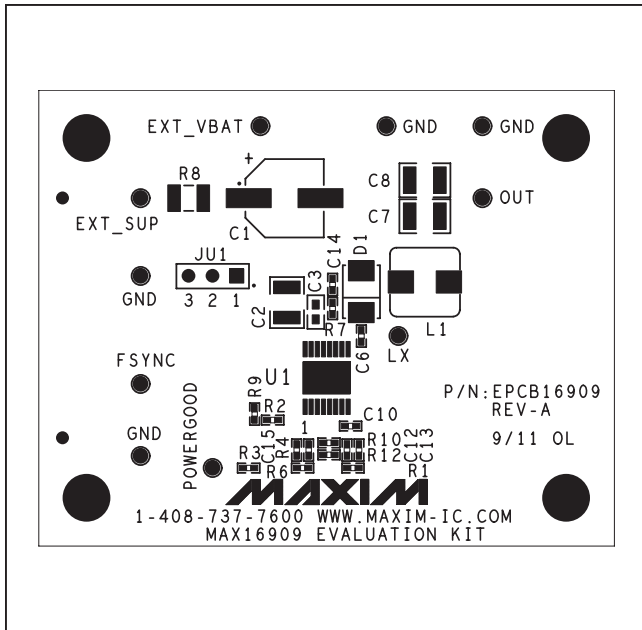

Figure 2. MAX16909 EV Kit Component Placement Guide—Component Side

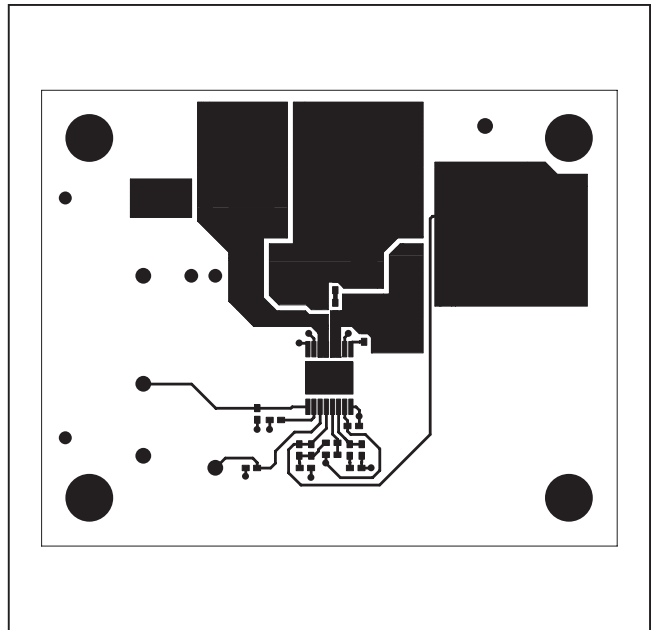

Figure 3. MAX16909 EV Kit PCB Layout—Component Side

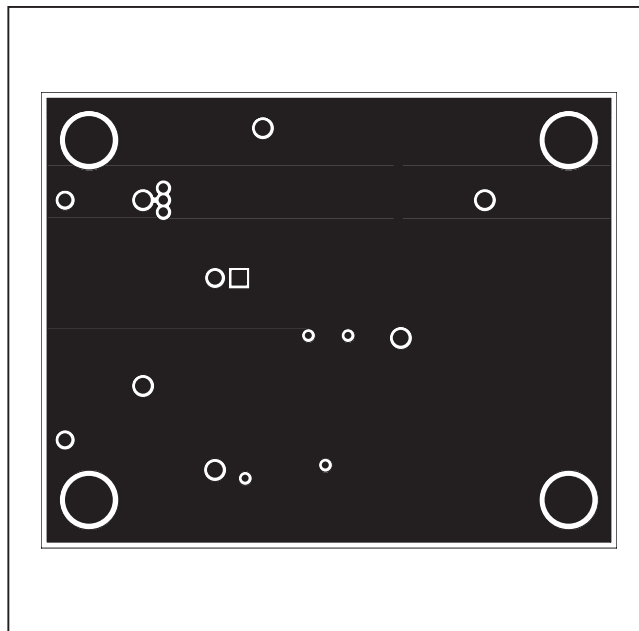

Figure 4. MAX16909 EV Kit PCB Layout—Layer 2

MAX16909 Evaluation Kit

Evaluates: MAX16909

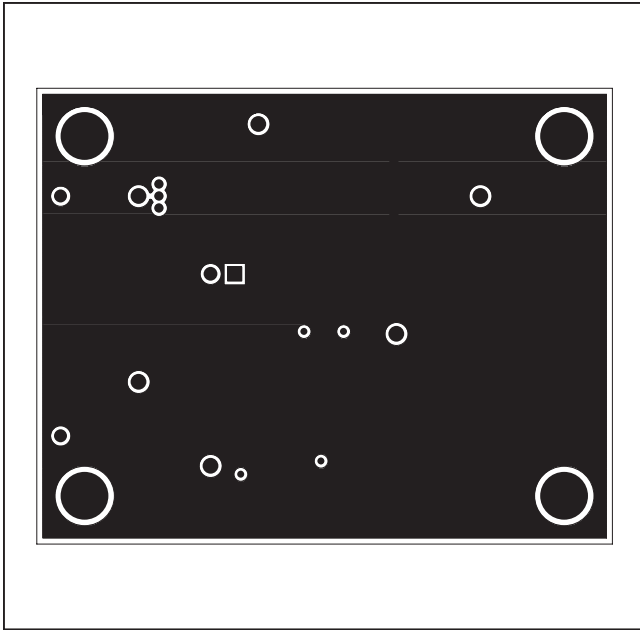

Figure 5. MAX16909 EV Kit PCB Layout—Layer 3

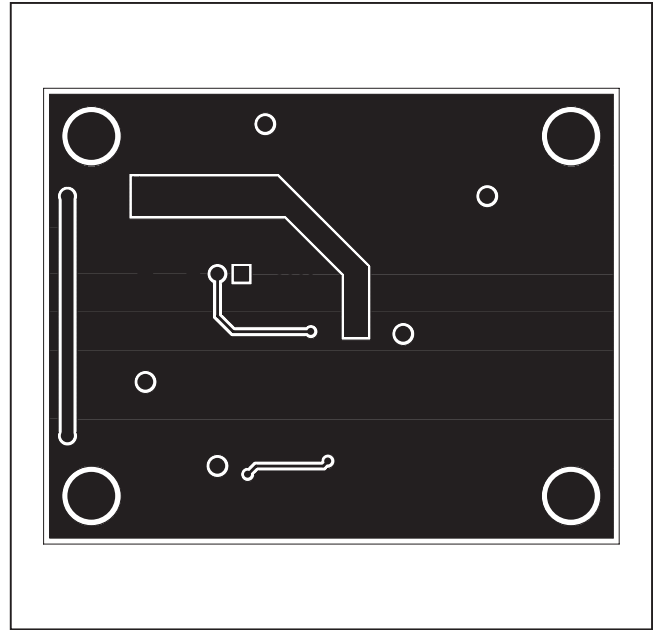

Figure 6. MAX16909 EV Kit PCB Layout—Solder Side

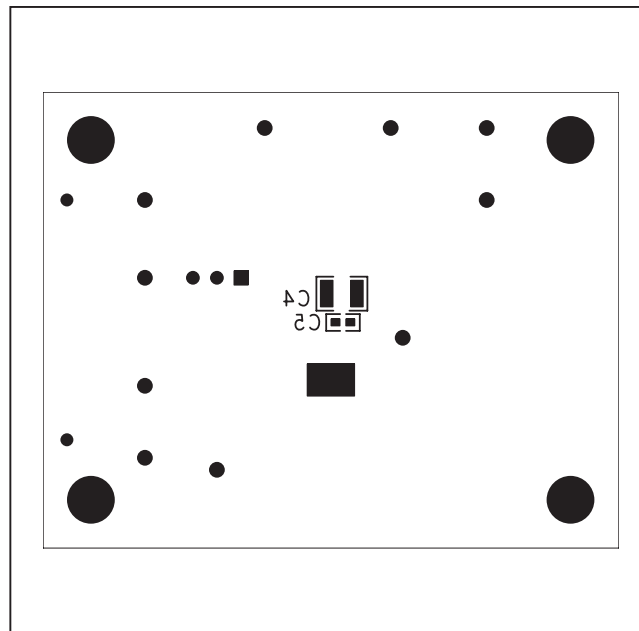

Figure 7. MAX16909 EV Kit Component Placement Guide—Solder Side

MAX16909 Evaluation Kit

Evaluates: MAX16909

Ordering Information

PART	TYPE
MAX16909EVKIT#	EV Kit

#Denotes RoHS compliant.

MAX16909 Evaluation Kit

Evaluates: MAX16909

Revision History

REVISION NUMBER	REVISION DATE	DESCRIPTION	PAGES CHANGED
0	10/11	Initial release	—

Maxim cannot assume responsibility for use of any circuitry other than circuitry entirely embodied in a Maxim product. No circuit patent licenses are implied. Maxim reserves the right to change the circuitry and specifications without notice at any time.

Maxim Integrated Products, 120 San Gabriel Drive, Sunnyvale, CA 94086 408-737-7600 _____ 7

Mouser Electronics

Authorized Distributor

Click to View Pricing, Inventory, Delivery & Lifecycle Information:

[Analog Devices Inc.:](#)

[MAX16909EVKIT#](#)