

Micropower, High Accuracy Voltage Reference
FEATURES

- ▶ Maximum temperature coefficient
 - ▶ 4 ppm/°C (C grade, -40°C to +85°C)
- ▶ Low long-term drift (LTD): 30 ppm (initial 1 khr typical)
- ▶ Initial output voltage error: $\pm 0.1\%$ (maximum)
- ▶ Operating temperature range: -40°C to +125°C
- ▶ Output current: +10 mA source/-3 mA sink
- ▶ Low quiescent current: 100 μ A (maximum)
- ▶ Low dropout voltage: 1.15 V at 2 mA
- ▶ Output voltage noise (0.1 Hz to 10 Hz): 8 μ V p-p (typical)
- ▶ Qualified for automotive applications

APPLICATIONS

- ▶ Automotive battery monitors
- ▶ Portable instrumentation
- ▶ Process transmitters
- ▶ Remote sensors
- ▶ Medical instrumentation

GENERAL DESCRIPTION

The ADR3512 is a low cost, low power, high precision CMOS voltage reference, featuring a maximum temperature coefficient (TC) of 4 ppm/°C (C grade, -40°C to +85°C), low operating current, and low output noise in an 8-lead MSOP package. For high accuracy, the output voltage and temperature coefficient are trimmed digitally during final assembly using the Analog Devices, Inc., patented DigiTrim® technology.¹

PIN CONFIGURATION

NOTES

1. DNC = DO NOT CONNECT. DO NOT CONNECT TO THIS PIN.

Figure 1. 8-Lead MSOP (RM-8 Suffix)

The low output voltage hysteresis and low long-term output voltage drift improve lifetime system accuracy.

This CMOS reference is specified over the automotive temperature range of -40°C to +125°C.

Table 1. Selection Guide

Model	Output Voltage (V)	Input Voltage Range (V)
ADR3512WCRMZ-R7	1.200	2.3 to 5.5

¹ At least U.S. Patent No. 6,696,894 covers this technology.

TABLE OF CONTENTS

Features.....	1	Line Regulation.....	12
Applications.....	1	Load Regulation.....	12
Pin Configuration.....	1	Solder Heat Resistance (SHR) Drift.....	12
General Description.....	1	Theory of Operation.....	13
Specifications.....	3	Long-Term Output Voltage Drift.....	13
Electrical Characteristics.....	3	Power Dissipation.....	13
Absolute Maximum Ratings.....	4	Applications Information.....	14
Thermal Resistance.....	4	Basic Voltage Reference Connection.....	14
ESD Caution.....	4	Input and Output Capacitors.....	14
Pin Configuration and Function Descriptions.....	5	4-Wire Kelvin Connections.....	14
Typical Performance Characteristics.....	6	V _{IN} Slew Rate Considerations.....	14
Terminology.....	12	Shutdown/Enable Feature.....	14
Dropout Voltage (V _{DO}).....	12	Sample Applications.....	15
Temperature Coefficient (TCV _{OUT}).....	12	Outline Dimensions.....	16
Thermally Induced Output Voltage		Ordering Guide.....	16
Hysteresis (ΔV _{OUT_HYS}).....	12	Automotive Products.....	16
Long-Term Output Voltage Drift (ΔV _{OUT_LTD})...	12		

REVISION HISTORY**8/2022—Rev. E to Rev. F**

Changes to Theory of Operation Section.....	13
Change to Figure 37.....	14

SPECIFICATIONS

ELECTRICAL CHARACTERISTICS

$V_{IN} = 2.3\text{ V to }5.5\text{ V}$, $I_L = 0\text{ mA}$, $T_A = 25^\circ\text{C}$, unless otherwise noted.

Table 2.

Parameter	Symbol	Test Conditions/Comments	Min	Typ	Max	Unit
OUTPUT VOLTAGE	V_{OUT}		1.1988	1.2000	1.2012	V
INITIAL OUTPUT VOLTAGE ERROR	V_{OERR}				± 0.1 ± 1.2	% mV
TEMPERATURE COEFFICIENT ¹	TCV_{OUT}	$-40^\circ\text{C} \leq T_A \leq +85^\circ\text{C}$ $-40^\circ\text{C} \leq T_A \leq +125^\circ\text{C}$		2.5 2.8	4 8	ppm/ $^\circ\text{C}$ ppm/ $^\circ\text{C}$
LINE REGULATION ¹	$\Delta V_{OUT}/\Delta V_{IN}$	$V_{IN} = 2.7\text{ V to }5.5\text{ V}$ $V_{IN} = 2.7\text{ V to }5.5\text{ V}, -40^\circ\text{C} \leq T_A \leq +125^\circ\text{C}$		5	50 160	ppm/V ppm/V
LOAD REGULATION ¹	$\Delta V_{OUT}/\Delta I_L$					
Sourcing		$I_L = 0\text{ mA to }10\text{ mA}, V_{IN} = 3.0\text{ V},$ $-40^\circ\text{C} \leq T_A \leq +125^\circ\text{C}$		14	30	ppm/mA
Sinking		$I_L = 0\text{ mA to }-3\text{ mA}, V_{IN} = 3.0\text{ V},$ $-40^\circ\text{C} \leq T_A \leq +125^\circ\text{C}$		7	50	ppm/mA
OUTPUT CURRENT CAPACITY	I_L					
Sourcing		$V_{IN} = 3.0\text{ V to }5.5\text{ V}$	10			mA
Sinking		$V_{IN} = 3.0\text{ V to }5.5\text{ V}$	-3			mA
QUIESCENT CURRENT	I_Q					
Normal Operation		$\text{ENABLE} \geq V_{IN} \times 0.85$ $\text{ENABLE} = V_{IN}, -40^\circ\text{C} \leq T_A \leq +125^\circ\text{C}$			85 100	μA μA
Shutdown		$\text{ENABLE} \leq 0.7\text{ V}$			5	μA
DROPOUT VOLTAGE ²	V_{DO}	$I_L = 0\text{ mA}, T_A = -40^\circ\text{C} \leq T_A \leq +125^\circ\text{C}$ $I_L = 2\text{ mA}, T_A = -40^\circ\text{C} \leq T_A \leq +125^\circ\text{C}$		1 1	1.1 1.15	V V
ENABLE PIN						
Shutdown Voltage	V_L		0		0.7	V
ENABLE Voltage	V_H		$V_{IN} \times 0.85$		V_{IN}	V
ENABLE Pin Leakage Current	I_{EN}	$\text{ENABLE} = V_{IN}, T_A = -40^\circ\text{C} \leq T_A \leq +125^\circ\text{C}$		1	3	μA
OUTPUT VOLTAGE NOISE	e_n p-p	$f = 0.1\text{ Hz to }10\text{ Hz}$ $f = 10\text{ Hz to }10\text{ kHz}$		8 28		$\mu\text{V p-p}$ $\mu\text{V rms}$
OUTPUT VOLTAGE NOISE DENSITY	e_n	$f = 1\text{ kHz}$		0.6		$\mu\text{V}/\sqrt{\text{Hz}}$
OUTPUT VOLTAGE HYSTERESIS ³	ΔV_{OUT_HYS}	$T_A = +25^\circ\text{C to }-40^\circ\text{C to }+125^\circ\text{C to }+25^\circ\text{C}$		70		ppm
RIPPLE REJECTION RATIO	RRR	$f_{IN} = 60\text{ Hz}$		-60		dB
LONG-TERM OUTPUT VOLTAGE DRIFT ¹	ΔV_{OUT_LTD}	1000 hours at 50°C		30		ppm
TURN-ON SETTLING TIME	t_R	$C_{IN} = 0.1\ \mu\text{F}, C_L = 0.1\ \mu\text{F}, R_L = 1\ \text{k}\Omega$		100		μs

¹ See the [Terminology](#) section.

² Dropout voltage refers to the minimum difference between V_{IN} and V_{OUT} such that V_{OUT} maintains a minimum accuracy of 0.1%. See the [Terminology](#) section.

³ See the [Terminology](#) section. The device is placed through the temperature cycle in the order of the temperatures shown.

ABSOLUTE MAXIMUM RATINGS**Table 3.**

Parameter	Rating
Supply Voltage	6 V
ENABLE to GND SENSE Voltage	V_{IN}
Operating Temperature Range	-40°C to +125°C
Storage Temperature Range	-65°C to +150°C
Junction Temperature Range	-65°C to +150°C

Stresses at or above those listed under Absolute Maximum Ratings may cause permanent damage to the product. This is a stress rating only; functional operation of the product at these or any other conditions above those indicated in the operational section of this specification is not implied. Operation beyond the maximum operating conditions for extended periods may affect product reliability.

THERMAL RESISTANCE

θ_{JA} is specified for the worst-case conditions, that is, a device soldered in a circuit board for surface-mount packages.

Table 4. Thermal Resistance

Package Type	θ_{JA}	θ_{JC}	Unit
8-Lead MSOP (RM-8 Suffix)	132.5	43.9	°C/W

ESD CAUTION

ESD (electrostatic discharge) sensitive device. Charged devices and circuit boards can discharge without detection. Although this product features patented or proprietary protection circuitry, damage may occur on devices subjected to high energy ESD. Therefore, proper ESD precautions should be taken to avoid performance degradation or loss of functionality.

PIN CONFIGURATION AND FUNCTION DESCRIPTIONS



NOTES
1. DNC = DO NOT CONNECT. DO NOT CONNECT TO THIS PIN. 

Figure 2. Pin Configuration

Table 5. Pin Function Descriptions

Pin No.	Mnemonic	Description
1	ENABLE	Enable Connection. This pin enables or disables the device.
2	GND SENSE	Ground Voltage Sense Connection. Connect this pin directly to the point of the lowest potential in the application.
3	GND FORCE	Ground Force Connection.
4	DNC	Do Not Connect. Do not connect to this pin.
5	DNC	Do Not Connect. Do not connect to this pin.
6	V _{OUT} FORCE	Reference Voltage Output.
7	V _{OUT} SENSE	Reference Voltage Output Sensing Connection. Connect this pin directly to the voltage input of the load devices.
8	V _{IN}	Input Voltage Connection.

TYPICAL PERFORMANCE CHARACTERISTICS

T_A = 25°C, unless otherwise noted.

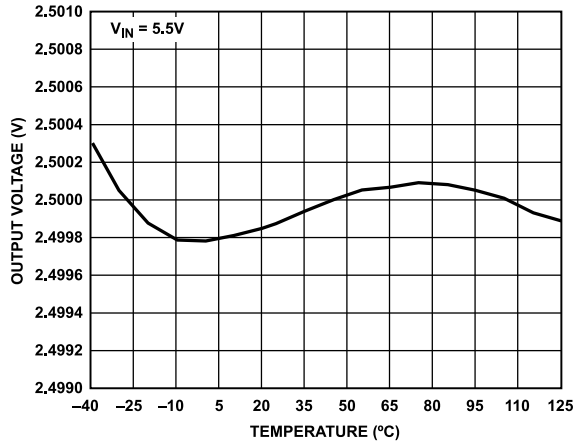

Figure 3. ADR3525 Output Voltage vs. Temperature

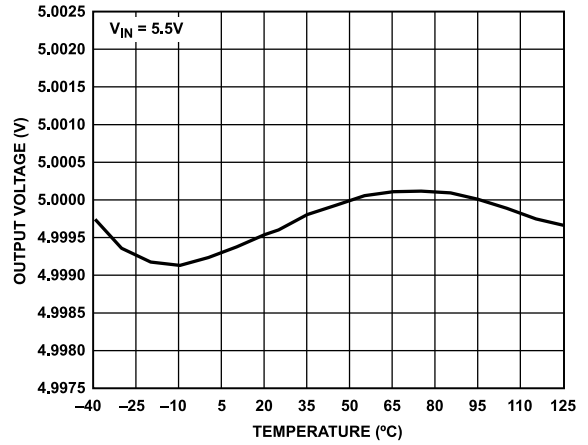

Figure 6. ADR3550 Output Voltage vs. Temperature

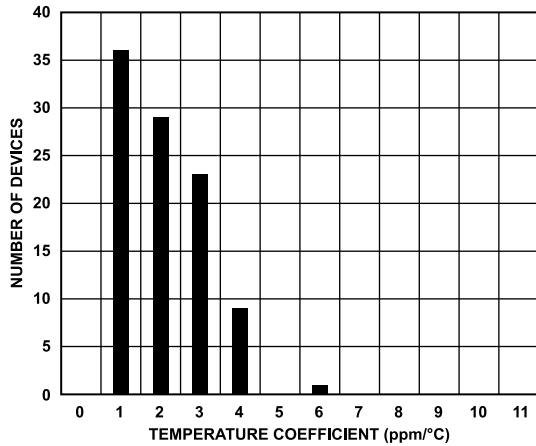

Figure 4. ADR3525 Temperature Coefficient Distribution

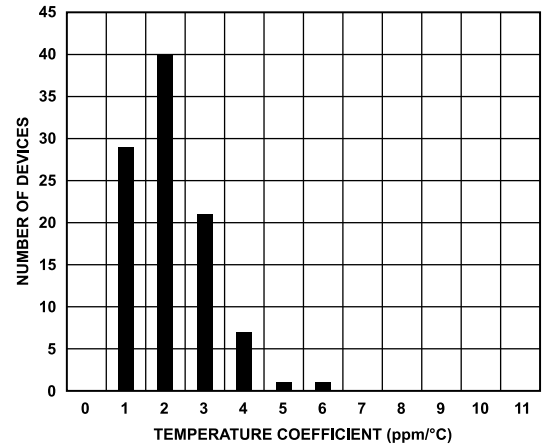

Figure 7. ADR3550 Temperature Coefficient Distribution

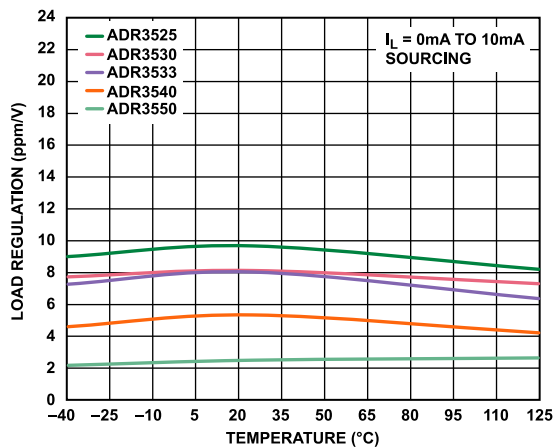

Figure 5. Load Regulation vs. Temperature (Sourcing)

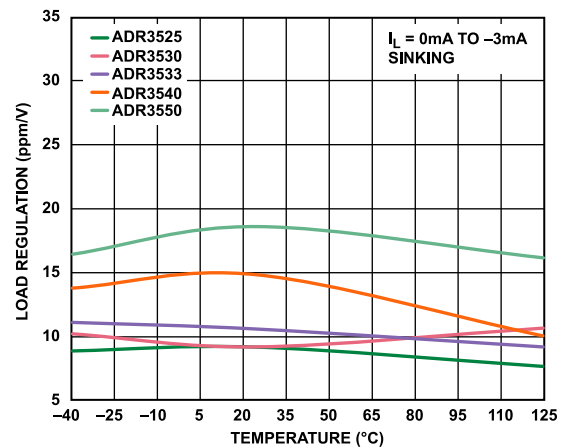

Figure 8. Load Regulation vs. Temperature (Sinking)

TYPICAL PERFORMANCE CHARACTERISTICS

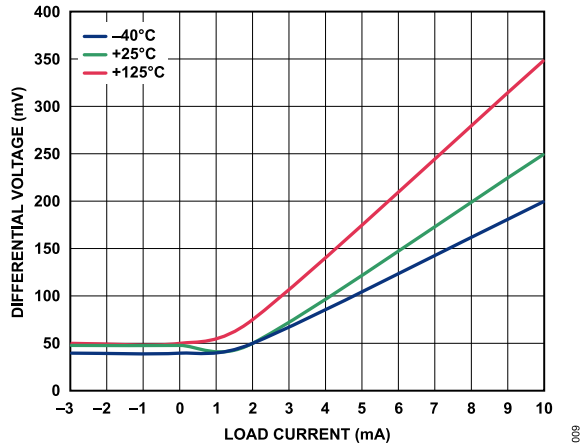

Figure 9. ADR3525 Dropout Voltage vs. Load Current

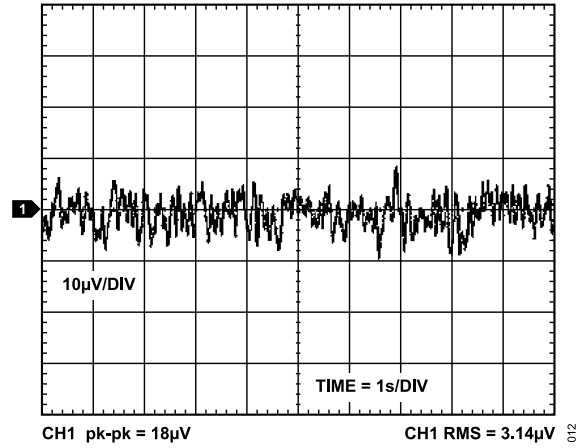

Figure 12. ADR3525 Output Voltage Noise (0.1 Hz to 10 Hz)

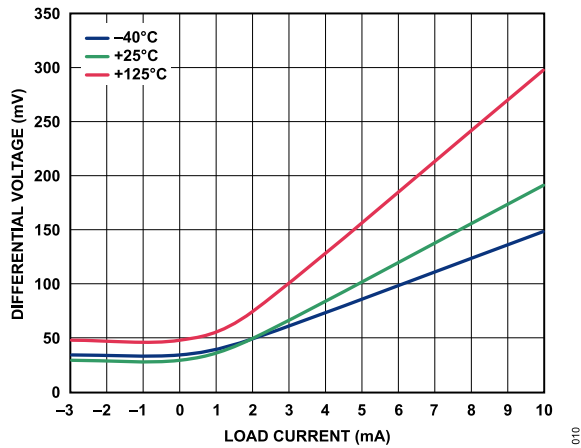

Figure 10. ADR3550 Dropout Voltage vs. Load Current

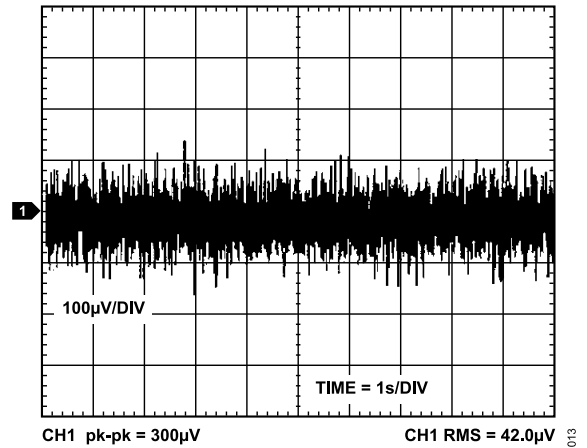

Figure 13. ADR3525 Output Voltage Noise (10 Hz to 10 kHz)

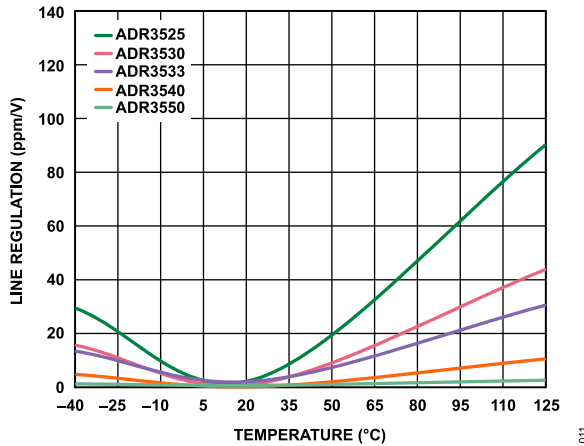

Figure 11. Line Regulation vs. Temperature

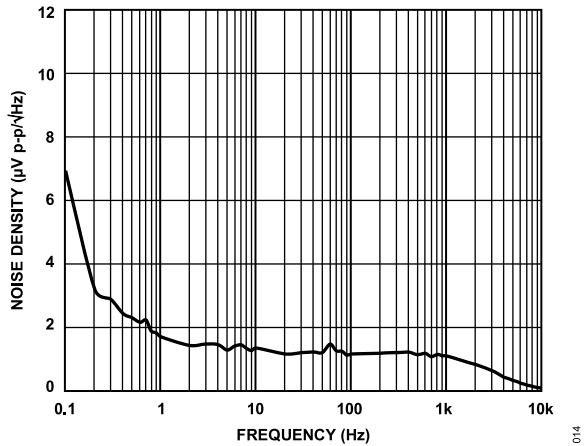

Figure 14. ADR3525 Output Noise Spectral Density

TYPICAL PERFORMANCE CHARACTERISTICS

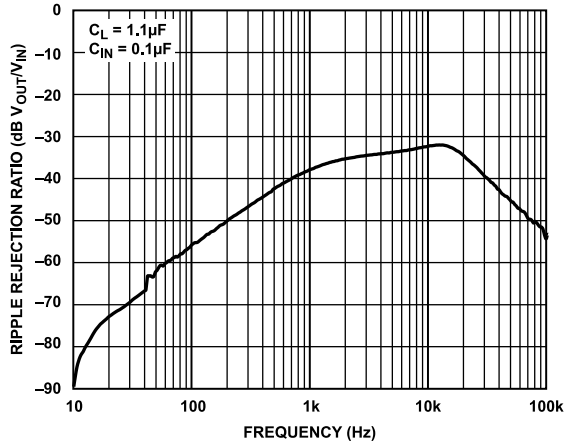

Figure 15. ADR3525 Ripple Rejection Ratio vs. Frequency

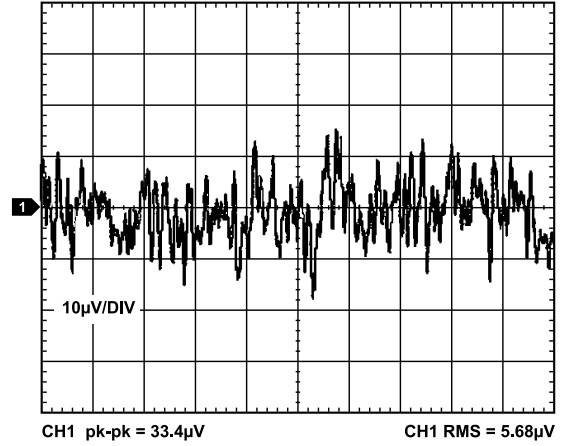

Figure 18. ADR3550 Output Voltage Noise (0.1 Hz to 10 Hz)

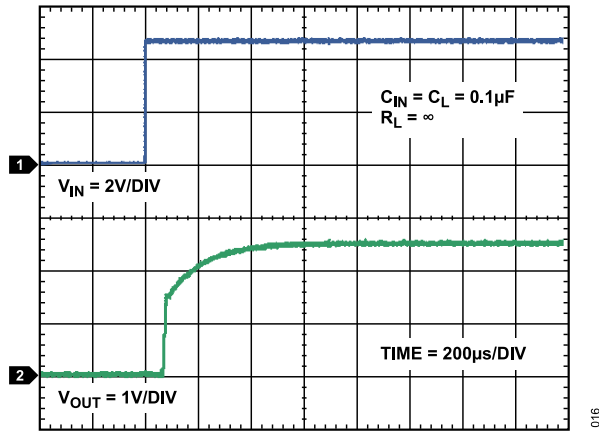

Figure 16. ADR3525 Start-Up Response

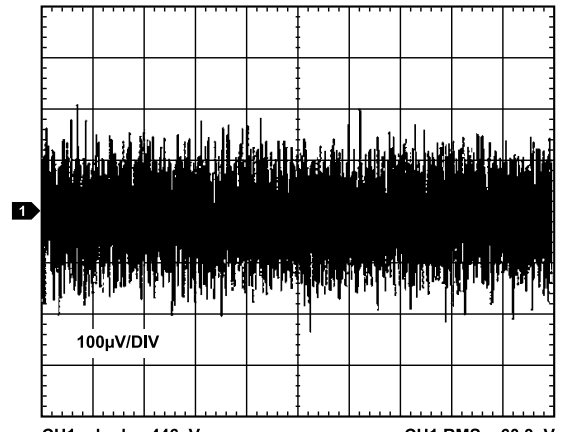

Figure 19. ADR3550 Output Voltage Noise (10 Hz to 10 kHz)

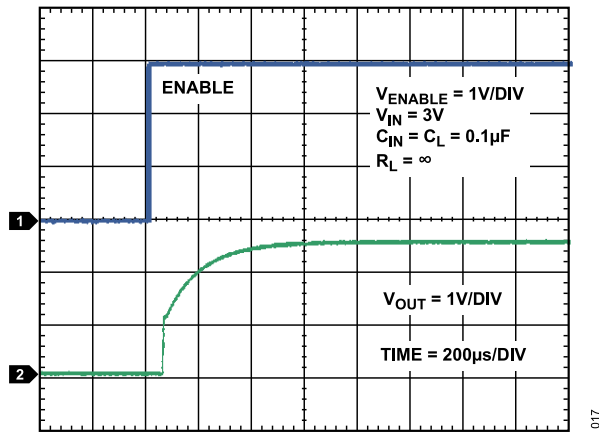

Figure 17. ADR3525 Restart Response from Shutdown

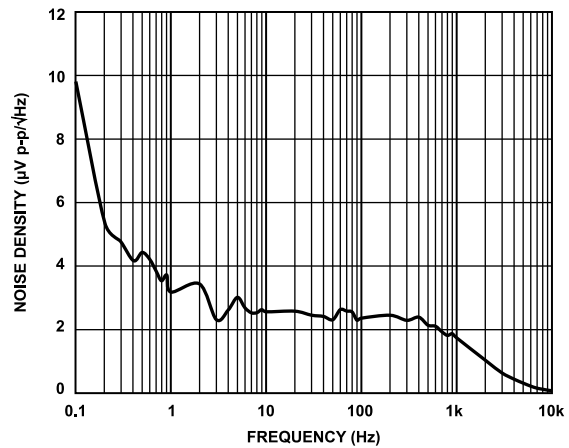

Figure 20. ADR3550 Output Noise Spectral Density

TYPICAL PERFORMANCE CHARACTERISTICS

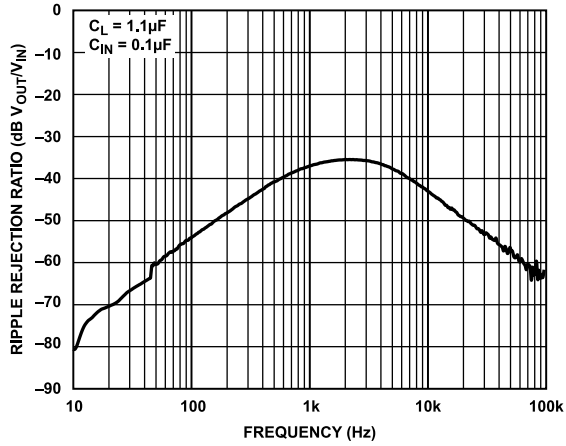

Figure 21. ADR3550 Ripple Rejection Ratio vs. Frequency

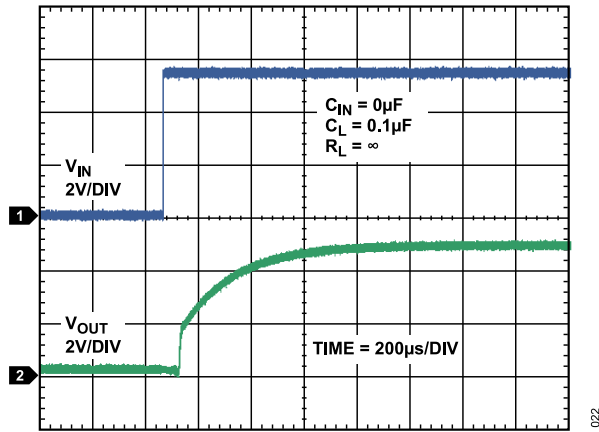

Figure 22. ADR3550 Start-Up Response

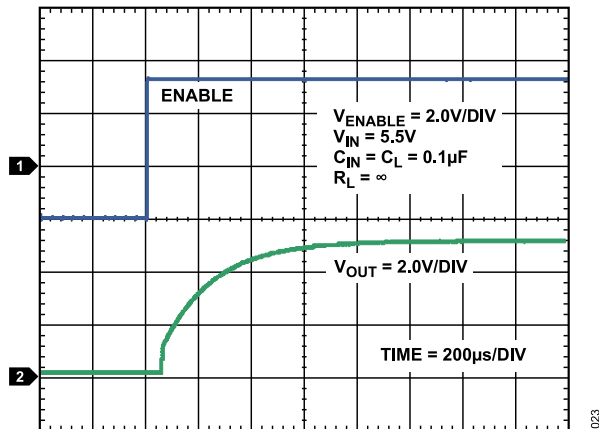

Figure 23. ADR3550 Restart Response from Shutdown

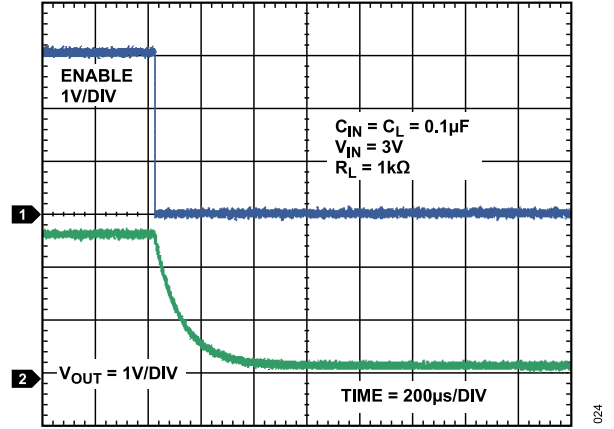

Figure 24. ADR3525 Shutdown Response

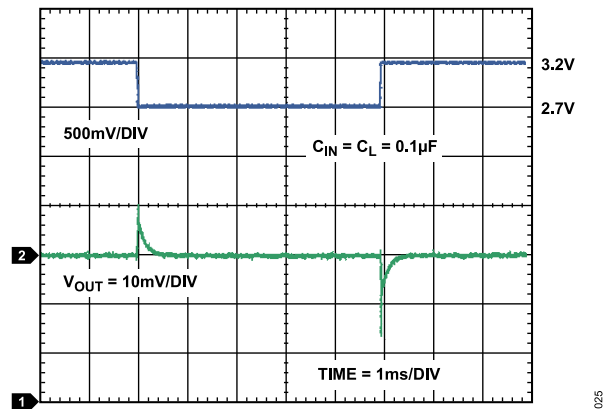

Figure 25. ADR3525 Line Transient Response

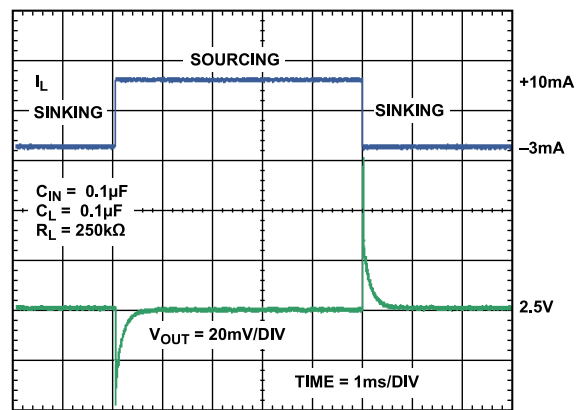

Figure 26. ADR3525 Load Transient Response

TYPICAL PERFORMANCE CHARACTERISTICS

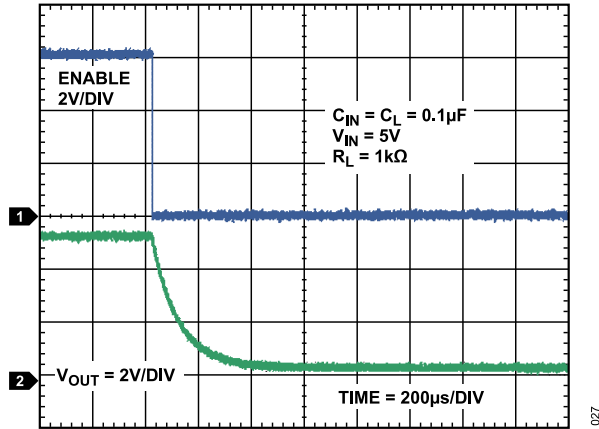

Figure 27. ADR3550 Shutdown Response

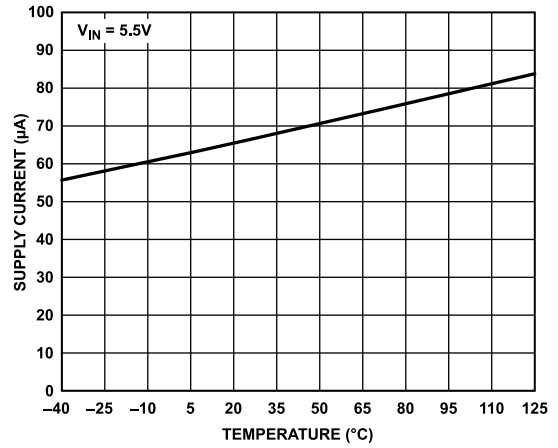

Figure 30. Supply Current vs. Temperature

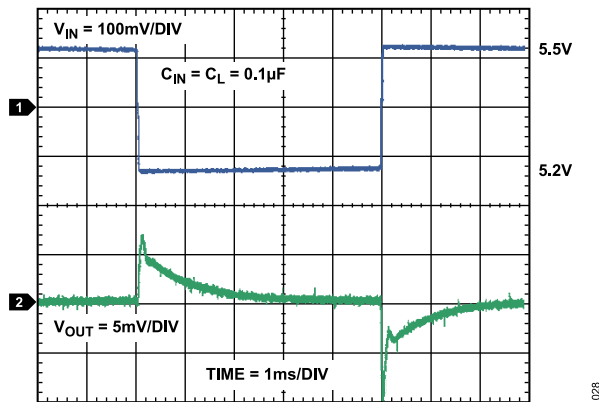

Figure 28. ADR3550 Line Transient Response

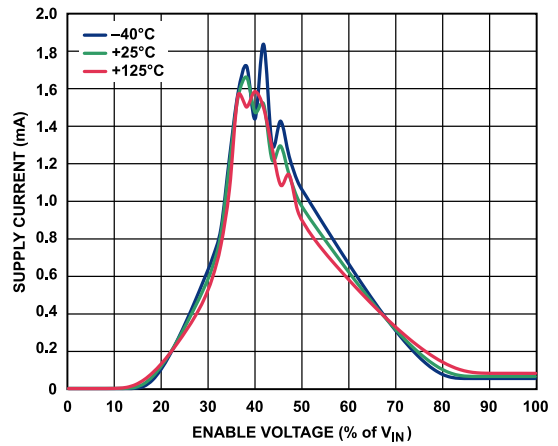

Figure 31. Supply Current vs. ENABLE Pin Voltage

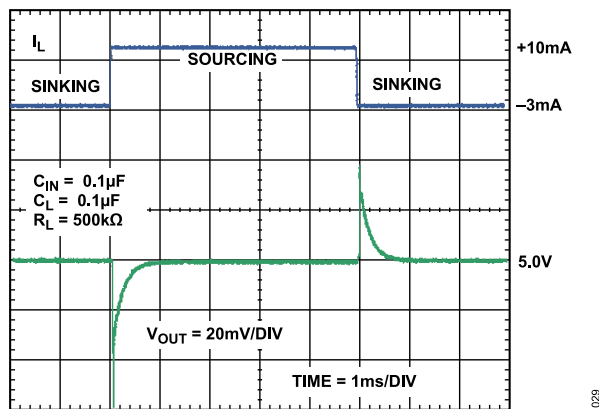

Figure 29. ADR3550 Load Transient Response

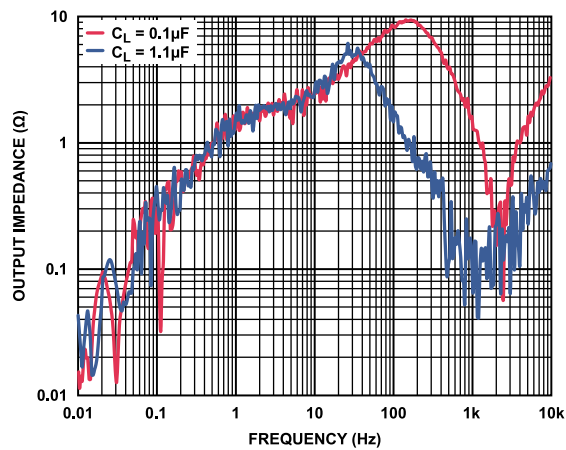

Figure 32. ADR3550 Output Impedance vs. Frequency

TYPICAL PERFORMANCE CHARACTERISTICS

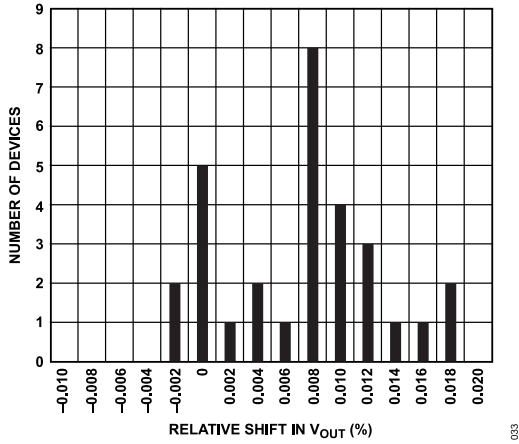

Figure 33. Output Voltage Drift Distribution After Reflow (SHR Drift)

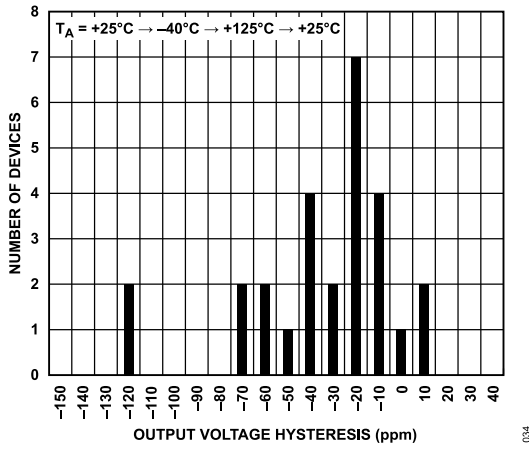

Figure 34. ADR3550 Thermally Induced Output Voltage Hysteresis Distribution

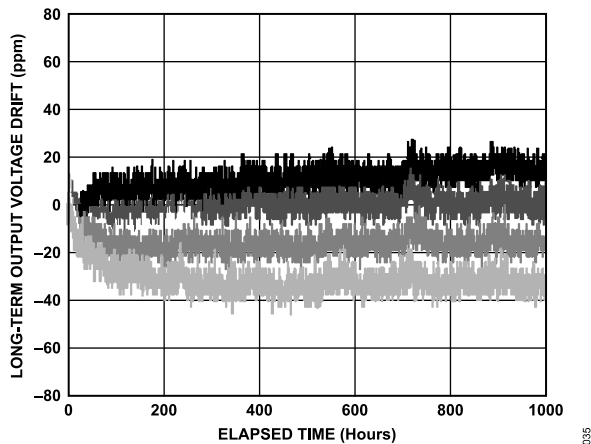

Figure 35. ADR3550 Typical Long-Term Output Voltage Drift (Four Devices, 1000 Hours)

TERMINOLOGY

Dropout Voltage (V_{DO})

Dropout voltage, sometimes referred to as supply voltage headroom or supply output voltage differential, is defined as the minimum voltage differential between the input and output such that the output voltage is maintained to within 0.1% accuracy.

$$V_{DO} = (V_{IN} - V_{OUT})_{MIN}|_L = \text{Constant}$$

Because the dropout voltage depends on the current passing through the device, it is always specified for a given load current. In series mode devices, dropout voltage typically increases proportionally to load current (see [Figure 9](#) and [Figure 10](#)).

Temperature Coefficient (TCV_{OUT})

The temperature coefficient relates the change in the output voltage to the change in ambient temperature of the device, as normalized by the output voltage at 25°C. This parameter is determined by the box method and is calculated using the following equation:

$$TCV_{OUT} = \left| \frac{\max(V_{OUT}(T_1, T_2, T_3)) - \min(V_{OUT}(T_1, T_2, T_3))}{V_{OUT}(T_2) \times (T_3 - T_2)} \right| \times 10^6$$

where:

TCV_{OUT} is expressed in ppm/°C.

$V_{OUT}(T_x)$ is the output voltage at Temperature T_x .

$T_1 = -40^\circ\text{C}$.

$T_2 = +25^\circ\text{C}$.

$T_3 = +125^\circ\text{C}$.

This three-point method ensures that TCV_{OUT} accurately portrays the maximum difference between any of the three temperatures at which the output voltage of the device is measured.

The ADR3512 is tested at three temperatures to determine

TCV_{OUT} : -40°C , $+25^\circ\text{C}$, and $+85^\circ\text{C}$.

Thermally Induced Output Voltage Hysteresis (ΔV_{OUT_HYS})

Thermally induced output voltage hysteresis represents the change in output voltage after the device is exposed to a specified temperature cycle. This is expressed as either a shift in voltage or a difference in ppm from the nominal output.

$$\Delta V_{OUT_HYS} = V_{OUT}(25^\circ\text{C}) - V_{OUT_TC} [V]$$

$$\Delta V_{OUT_HYS} = \frac{V_{OUT}(25^\circ\text{C}) - V_{OUT_TC}}{V_{OUT}(25^\circ\text{C})} \times 10^6 [\text{ppm}]$$

where:

$V_{OUT}(25^\circ\text{C})$ is the output voltage at 25°C.

V_{OUT_TC} is the output voltage after temperature cycling.

Long-Term Output Voltage Drift (ΔV_{OUT_LTD})

Long-term output voltage drift refers to the shift in output voltage after 1000 hours of operation in a constant 50°C environment. This is expressed as either a shift in voltage or a difference in ppm from the nominal output.

$$\Delta V_{OUT_LTD} = |V_{OUT}(t_1) - V_{OUT}(t_0)| [V]$$

$$\Delta V_{OUT_LTD} = \left| \frac{V_{OUT}(t_1) - V_{OUT}(t_0)}{V_{OUT}(t_0)} \right| \times 10^6 [\text{ppm}]$$

where:

$V_{OUT}(t_0)$ is the V_{OUT} at 50°C at Time 0.

$V_{OUT}(t_1)$ is the V_{OUT} at 50°C after 1000 hours of operation at 50°C.

Line Regulation

Line regulation refers to the change in output voltage in response to a given change in input voltage and is expressed in percent per volt, ppm per volt, or microvolts per volt change in input voltage. This parameter accounts for the effects of self heating.

Load Regulation

Load regulation refers to the change in output voltage in response to a given change in load current and is expressed in microvolts per mA, ppm per mA, or ohms of dc output resistance. This parameter accounts for the effects of self heating.

Solder Heat Resistance (SHR) Drift

SHR drift refers to the permanent shift in output voltage induced by exposure to reflow soldering, expressed in units of ppm. SHR drift is caused by changes in the stress exhibited upon the die by the package materials when exposed to high temperatures. This effect is more pronounced in lead-free soldering processes due to higher reflow temperatures.

THEORY OF OPERATION

The ADR3512 uses a patented voltage reference architecture to achieve high accuracy, low TC, and low noise in a CMOS process. Like all band gap references, the reference combines two voltages of opposite TCs to create an output voltage that is nearly independent of ambient temperature. However, unlike traditional band gap voltage references, the temperature independent voltage of the reference is arranged to be the base emitter voltage, V_{BE} , of a bipolar transistor at room temperature rather than the V_{BE} extrapolated to 0 K (the V_{BE} of a bipolar transistor at 0 K is approximately V_{G0} , the band gap voltage of the silicon). Then, a corresponding positive TC voltage is added to the V_{BE} voltage to compensate for its negative TC.

The key benefit of this technique is that the trimming of the initial accuracy and TC can be performed without interfering with one another, thereby increasing overall accuracy across temperature. Curvature correction techniques further reduce the temperature variation.

The band gap voltage (V_{BG}) is then buffered and amplified to produce stable output voltage of 1.2 V. The output buffer can source up to +10 mA and sink up to -3 mA of load current.

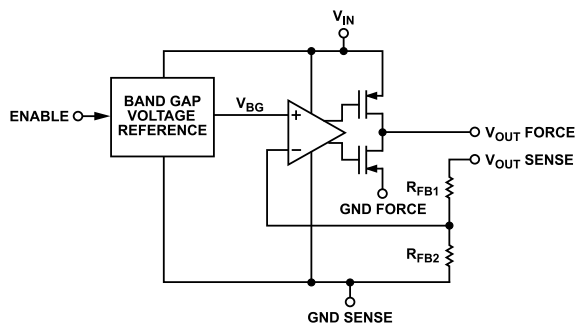

Figure 36. Block Diagram

The ADR3512 reference leverages Analog Devices patented Dig-iTrim technology to achieve high initial accuracy and low TC. Precision layout techniques lead to very low long-term drift and thermal hysteresis.

LONG-TERM OUTPUT VOLTAGE DRIFT

One of the key parameters of the ADR3512 reference is long-term output voltage drift. Independent of the output voltage model and in a 50°C environment, this device exhibits a typical drift of approximately 30 ppm after 1000 hours of continuous, unloaded operation.

It is important to understand that long-term output voltage drift is not tested or guaranteed by design and that the output from the device may shift beyond the typical 30 ppm specification. Because most of the drift occurs in the first 200 hours of device operation, burning in the system board with the reference mounted can reduce subsequent output voltage drift over time. See the [AN-713 Application Note, The Effect of Long-Term Drift on Voltage References](#), for more information regarding the effects of long-term drift and how it can be minimized.

POWER DISSIPATION

The ADR3512 voltage reference is capable of sourcing up to 10 mA of load current at room temperature across the rated input voltage range. However, when used in applications subject to high ambient temperatures, carefully monitor the input voltage and load current to ensure that the device does not exceed its maximum power dissipation rating. The maximum power dissipation of the device can be calculated by

$$P_D = \frac{T_J - T_A}{\theta_{JA}} \text{ [W]}$$

where:

P_D is the device power dissipation.

T_J is the device junction temperature.

T_A is the ambient temperature.

θ_{JA} is the package (junction to air) thermal resistance.

Because of this relationship, the acceptable load current in high temperature conditions may be less than the maximum current sourcing capability of the device. The device must not be operated outside of its maximum power rating because doing so can result in premature failure or permanent damage to the device.

APPLICATIONS INFORMATION

BASIC VOLTAGE REFERENCE CONNECTION

The circuit shown in [Figure 37](#) shows the basic configuration for the ADR3512 reference. Connect bypass capacitors according to the guidelines in the following sections.

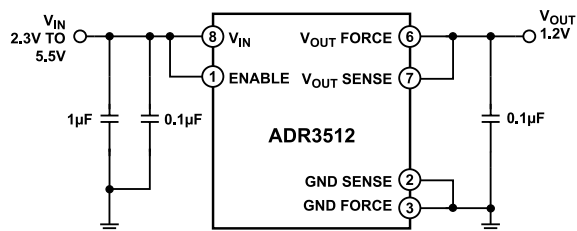

Figure 37. Basic Reference Connection

INPUT AND OUTPUT CAPACITORS

Connect a 1 μF to 10 μF electrolytic or ceramic capacitor to the input to improve transient response in applications where the supply voltage may fluctuate. Connect an additional 0.1 μF ceramic capacitor in parallel to reduce high frequency supply noise.

Connect a ceramic capacitor of at least a 0.1 μF to the output to improve stability and help filter out high frequency noise. An additional 1 μF to 10 μF electrolytic or ceramic capacitor can be added in parallel to improve transient performance in response to sudden changes in load current; however, note that doing so increases the turn-on time of the device.

Best performance and stability is attained with low equivalent series resistance (ESR) (for example, less than 1 Ω), low inductance, ceramic chip type output capacitors (X5R, X7R, or similar). If using an electrolytic capacitor on the output, place a 0.1 μF ceramic capacitor in parallel to reduce overall ESR on the output.

4-WIRE KELVIN CONNECTIONS

Current flowing through a printed circuit board (PCB) trace produces an IR voltage drop. With longer traces, this drop can reach several millivolts or more, introducing a considerable error into the output voltage of the reference. A 1 inch long, 5 mm wide trace of 1 ounce copper has a resistance of approximately 100 m Ω at room temperature; at a load current of 10 mA, this can introduce a full millivolt of error. In an ideal board layout, the reference is mounted as close to the load as possible to minimize the length of the output traces, and, therefore, the error introduced by the voltage drop. However, in applications where this is not possible or convenient, force and sense connections (sometimes referred to as Kelvin sensing connections) are provided as a means of minimizing the IR drop and improving accuracy.

Kelvin connections work by providing a set of high impedance, voltage sensing lines to the output and ground nodes. Because very little current flows through these connections, the IR drop across their traces is negligible, and the output and ground voltages can be sensed accurately.

These voltages are fed back into the internal amplifier and are used to automatically correct for the voltage drop across the current carrying output and ground lines, resulting in a highly accurate output voltage across the load. To achieve the best performance, connect the sense connections directly to the point in the load where the output voltage is the most accurate. See [Figure 38](#) for an example application.

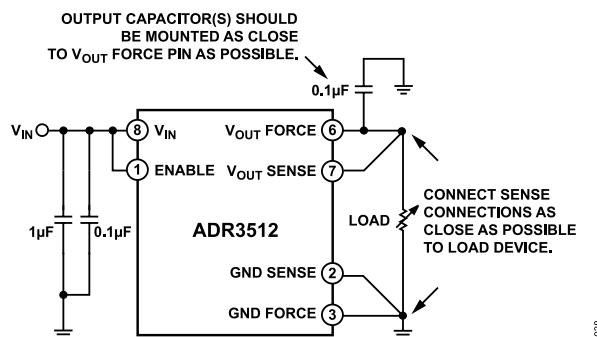

Figure 38. Application Showing Kelvin Connection

It is always advantageous to use Kelvin connections whenever possible. However, in applications where the IR drop is negligible or an extra set of traces cannot be routed to the load, the GND FORCE pin and the GND SENSE pin for both V_{OUT} and ground can simply be tied together, and the device can be used in the same way as a normal 3-terminal reference (see [Figure 37](#)).

 V_{IN} SLEW RATE CONSIDERATIONS

In applications with slow rising input voltage signals, the reference exhibits overshoot or other transient anomalies that appear on the output. These phenomena also appear during shutdown as the internal circuitry loses power.

To avoid such conditions, ensure that the input voltage waveform has both a rising and falling slew rate of at least 0.1 V/ms.

SHUTDOWN/ENABLE FEATURE

The ADR3512 reference can be switched to a low power shutdown mode when a voltage of 0.7 V or lower is input to the ENABLE pin. Likewise, the reference becomes operational for ENABLE voltages of $0.85 \times V_{\text{IN}}$ or higher. During shutdown, the supply current drops to less than 5 μA , useful in applications that are sensitive to power consumption.

If using the shutdown feature, ensure that the ENABLE pin voltage does not fall between 0.7 V and $0.85 \times V_{\text{IN}}$ because this causes a large increase in the supply current of the device and may keep the reference from starting up correctly (see [Figure 31](#)). If not using the shutdown feature, however, the ENABLE pin can be tied to the V_{IN} pin and the reference remains continuously operational.

APPLICATIONS INFORMATION

SAMPLE APPLICATIONS

Negative Reference

Figure 39 shows how to connect the ADR3512 and a standard CMOS operational amplifier, such as the AD8663, to provide a negative reference voltage. This configuration provides two main advantages: first, it requires only two devices and, therefore, does not require excessive board space. Second, it does not require any external resistors, meaning that the performance of this circuit does not rely on choosing expensive devices with low temperature coefficients to ensure accuracy.

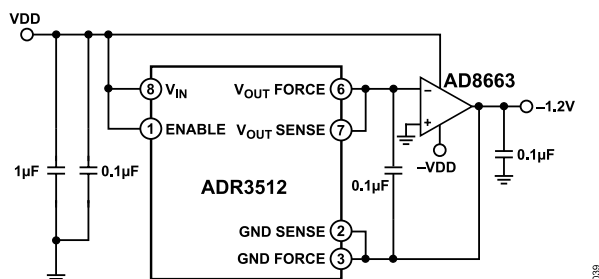

Figure 39. Negative Reference

In Figure 39, the V_{OUT} FORCE pin and the V_{OUT} SENSE pin of the reference sit at virtual ground. The negative reference voltage and load current are taken directly from the output of the operational amplifier. Note that, in applications where the negative supply voltage is close to the reference output voltage, a dual-supply, low offset, rail-to-rail output amplifier must be used to ensure an accurate output voltage. The operational amplifier must also be able to source or sink an appropriate amount of current for the application.

Bipolar Output Reference

Figure 40 shows a bipolar reference configuration. By connecting the output of the ADR3512 to the inverting terminal of an operational amplifier, it is possible to obtain both positive and negative reference voltages. Match Resistors R1 and R2 as close as possible to ensure minimal difference between the negative and positive outputs. Use resistors with low temperature coefficients if the circuit is used in environments with large temperature swings; otherwise, a voltage difference develops between the two outputs as the ambient temperature changes.

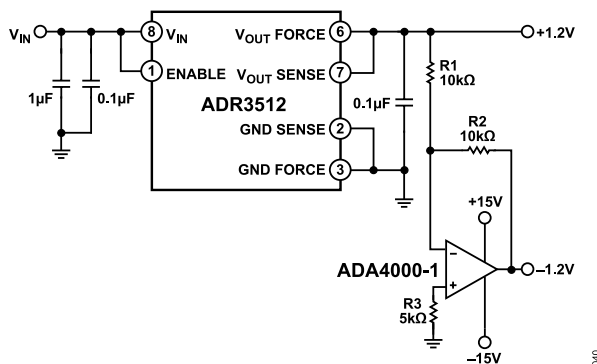

Figure 40. Bipolar Output Reference

Boosted Output Current Reference

Figure 41 shows a configuration for obtaining higher current drive capability from the ADR3512 reference without sacrificing accuracy. The operational amplifier regulates the current flow through the MOSFET until V_{OUT} equals the output voltage of the reference; current is then drawn directly from V_{IN} rather than from the reference itself, allowing increased current drive capability.

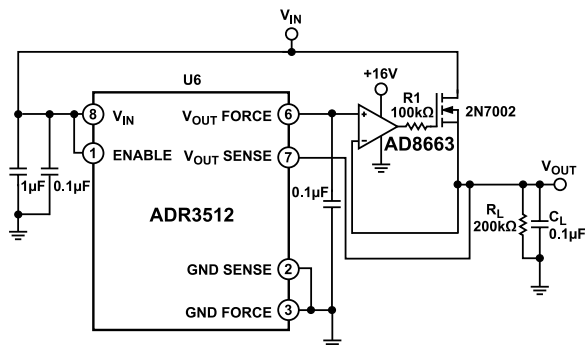
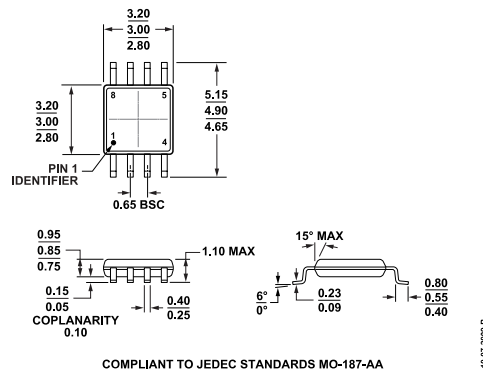

Figure 41. Boosted Output Current Reference

Because the current sourcing capability of this circuit depends only on the I_D rating of the MOSFET, the output drive capability can be adjusted to the application simply by choosing an appropriate MOSFET. In all cases, tie the V_{OUT} SENSE pin directly to the load device to maintain maximum output voltage accuracy.

OUTLINE DIMENSIONS



**Figure 42. 8-Lead Mini Small Outline Package [MSOP]
(RM-8)**
Dimensions show in millimeters

Updated: July 27, 2022

ORDERING GUIDE

Model ^{1, 2}	Temperature Range	Package Description	Packing Quantity	Package Option	Marking Code
ADR3512WCRMZ-R7	-40°C to +125°C	8-Lead MSOP	Reel, 1000	RM-8	R3K

¹ W = Qualified for Automotive

² Z = RoHS Compliant Part.

AUTOMOTIVE PRODUCTS

The ADR3512W models are available with controlled manufacturing to support the quality and reliability requirements of automotive applications. Note that these automotive models may have specifications that differ from the commercial models; therefore, designers should review the [Specifications](#) section of this data sheet carefully. Only the automotive grade products shown are available for use in automotive applications. Contact your local Analog Devices account representative for specific product ordering information and to obtain the specific Automotive Reliability reports for these models.

Mouser Electronics

Authorized Distributor

Click to View Pricing, Inventory, Delivery & Lifecycle Information:

[Analog Devices Inc.:](#)

[ADR3512WCRMZ-R7](#)