

1.5GHz to 2.5GHz High Linearity Direct Quadrature Modulator

FEATURES

- Direct Conversion from Baseband to RF
- High Output: -2.5dB Conversion Gain
- High OIP3: $+21.6\text{dBm}$ at 2GHz
- Low Output Noise Floor at 20MHz Offset:
 - No RF: -158.6dBm/Hz
 - $P_{\text{OUT}} = 4\text{dBm}$: -152.5dBm/Hz
- Low Carrier Leakage: -39.4dBm at 2GHz
- High Image Rejection: -41.2dBc at 2GHz
- 4-Channel W-CDMA ACPR: -67.7dBc at 2.14GHz
- Integrated LO Buffer and LO Quadrature Phase Generator
- 50Ω AC-Coupled Single-Ended LO and RF Ports
- High Impedance DC Interface to Baseband Inputs with 0.5V Common Mode Voltage
- 16-Lead QFN $4\text{mm} \times 4\text{mm}$ Package

APPLICATIONS

- Infrastructure Tx for DCS, PCS and UMTS Bands
- Image Reject Up-Converters for DCS, PCS and UMTS Bands
- Low Noise Variable Phase Shifter for 1.5GHz to 2.5GHz Local Oscillator Signals

DESCRIPTION

The LT5572 is a direct I/Q modulator designed for high performance wireless applications, including wireless infrastructure. It allows direct modulation of an RF signal using differential baseband I and Q signals. It supports PHS, GSM, EDGE, TD-SCDMA, CDMA, CDMA2000, W-CDMA and other systems. It may also be configured as an image reject up-converting mixer by applying 90° phase-shifted signals to the I and Q inputs. The high impedance I/Q baseband inputs consist of voltage-to-current converters that in turn drive double-balanced mixers. The outputs of these mixers are summed and applied to an on-chip RF transformer which converts the differential mixer signals to a 50Ω single-ended output. The four balanced I and Q baseband input ports are intended for DC coupling from a source with a common mode voltage level of about 0.5V . The LO path consists of an LO buffer with single-ended input and precision quadrature generators that produce the LO drive for the mixers. The supply voltage range is 4.5V to 5.25V .

LT, LTC and LT are registered trademarks of Linear Technology Corporation. All other trademarks are the property of their respective owners.

TYPICAL APPLICATION

Direct Conversion Transmitter Application

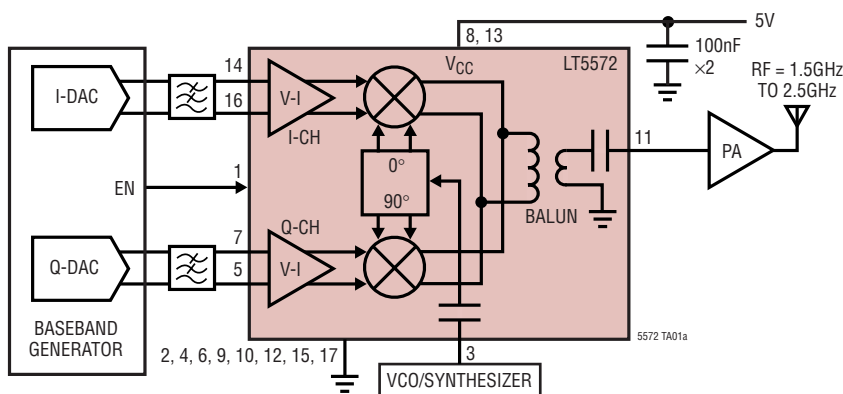

W-CDMA ACPR, AICPR and Noise vs RF Output Power at 2.14GHz for 1, 2 and 4 Channels

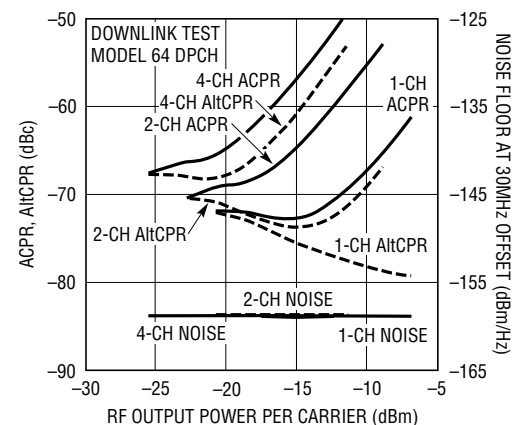

5572 TA01b

5572f

ABSOLUTE MAXIMUM RATINGS

(Note 1)
 Supply Voltage5.5V
 Common Mode Level of BBPI, BBMI
 and BBPQ, BBMQ.....0.6V
 Voltage on Any Pin
 Not to Exceed.....-500mV to (V_{CC} + 500mV)
 Operating Ambient Temperature Range
 (Note 2).....-40°C to 85°C
 Storage Temperature Range.....-65°C to 125°C

PACKAGE/ORDER INFORMATION

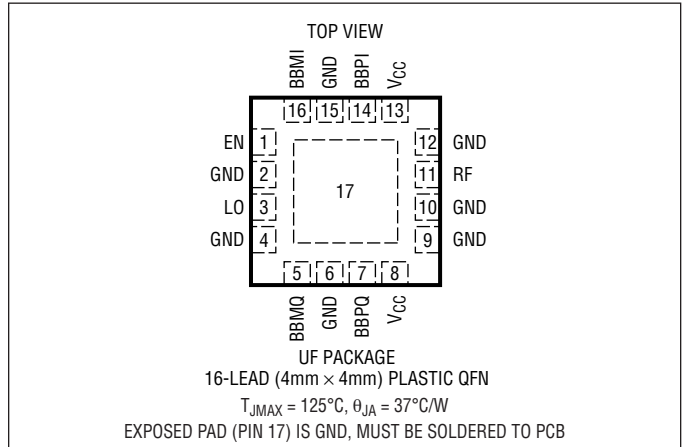

ORDER PART NUMBER	UF PART MARKING
LT5572EUF	5572

Order Options Tape and Reel: Add #TR
 Lead Free: Add #PBF Lead Free Tape and Reel: Add #TRPBF
 Lead Free Part Marking: <http://www.linear.com/leadfree/>

Consult LTC Marketing for parts specified with wider operating temperature ranges.

ELECTRICAL CHARACTERISTICS

V_{CC} = 5V, EN = High, T_A = 25°C, f_{LO} = 2GHz, f_{RF} = 2002MHz, P_{LO} = 0dBm.
 BBPI, BBMI, BBPQ, BBMQ inputs 0.5V_{DC}, baseband input frequency = 2MHz, I and Q 90° shifted (upper sideband selection).
 P_{RF(OUT)} = -10dBm, unless otherwise noted. (Note 3)

SYMBOL	PARAMETER	CONDITIONS	MIN	TYP	MAX	UNITS
RF Output (RF)						
f _{RF}	RF Frequency Range	-3dB Bandwidth -1dB Bandwidth		1.5 to 2.5 1.7 to 2.15		GHz GHz
S _{22(ON)}	RF Output Return Loss	EN = High (Note 6)		-13.5		dB
S _{22(OFF)}	RF Output Return Loss	EN = Low (Note 6)		-12.5		dB
NFloor	RF Output Noise Floor	No Input Signal (Note 8) P _{OUT} = 4dBm (Note 9) P _{OUT} = 4dBm (Note 10)		-158.6 -152.5 -152.2		dBm/Hz dBm/Hz dBm/Hz
G _V	Conversion Voltage Gain	20 • Log (V _{OUT(50Ω)} /V _{IN(DIFF) I or Q})		-2.5		dB
P _{OUT}	Output Power	1V _{PP(DIFF)} CW Signal, I and Q		1.4		dBm
G _{3LO VS LO}	3 • LO Conversion Gain Difference	(Note 17)		-29.5		dB
OP1dB	Output 1dB Compression	(Note 7)		9.3		dBm
OIP2	Output 2nd Order Intercept	(Notes 13, 14)		53.2		dBm
OIP3	Output 3rd Order Intercept	(Notes 13, 15)		21.6		dBm
IR	Image Rejection	(Note 16)		-41.2		dBc
LOFT	Carrier Leakage (LO Feedthrough)	EN = High, P _{LO} = 0dBm (Note 16) EN = Low, P _{LO} = 0dBm (Note 16)		-39.4 -58		dBm dBm

ELECTRICAL CHARACTERISTICS $V_{CC} = 5V$, $EN = High$, $T_A = 25^{\circ}C$, $f_{LO} = 2GHz$, $f_{RF} = 2002MHz$, $P_{LO} = 0dBm$.
BBPI, BBMI, BBPQ, BBMQ inputs $0.5V_{DC}$, baseband input frequency = 2MHz, I and Q 90° shifted (upper sideband selection).
 $P_{RF(OUT)} = -10dBm$, unless otherwise noted. (Note 3)

SYMBOL	PARAMETER	CONDITIONS	MIN	TYP	MAX	UNITS
LO Input (LO)						
f_{LO}	LO Frequency Range			1.5 to 2.5		GHz
P_{LO}	LO Input Power		-10	0	5	dBm
$S_{11(ON)}$	LO Input Return Loss	$EN = High$, $P_{LO} = 0dBm$ (Note 6)		-15		dB
$S_{11(OFF)}$	LO Input Return Loss	$EN = Low$ (Note 6)		-5.3		dB
NF_{LO}	LO Input Referred Noise Figure	at 2GHz (Note 5)		14.5		dB
G_{LO}	LO to RF Small-Signal Gain	at 2GHz (Note 5)		25		dB
$IIP3_{LO}$	LO Input 3rd Order Intercept	at 2GHz (Note 5)		-0.5		dBm

Baseband Inputs (BBPI, BBMI, BBPQ, BBMQ)

BW_{BB}	Baseband Bandwidth	-3dB Bandwidth		460		MHz
V_{CMBB}	DC Common Mode Voltage	Externally Applied (Note 4)		0.5	0.6	V
R_{IN}	Differential Input Resistance			90		k Ω
$I_{DC(IN)}$	Baseband Static Input Current	(Note 4)		-20		μA
P_{LOBB}	Carrier Feedthrough to BB	$P_{OUT} = 0$ (Note 4)		-39		dBm
IP1dB	Input 1dB Compression Point	Differential Peak-to-Peak (Notes 7, 18)		2.8		$V_{P-P(DIFF)}$
$\Delta G_{I/Q}$	I/Q Absolute Gain Imbalance			0.07		dB
$\Delta \phi_{I/Q}$	I/Q Absolute Phase Imbalance			0.9		Deg

Power Supply (V_{CC})

V_{CC}	Supply Voltage		4.5	5	5.25	V
$I_{CC(ON)}$	Supply Current	$EN = High$		120	145	mA
$I_{CC(OFF)}$	Supply Current, Sleep Mode	$EN = 0V$			50	μA
t_{ON}	Turn-On Time	$EN = Low$ to High (Note 11)		0.25		μs
t_{OFF}	Turn-Off Time	$EN = High$ to Low (Note 12)		1.3		μs

Enable (EN), Low = Off, High = On

Enable	Input High Voltage	$EN = High$	1			V
	Input High Current	$EN = 5V$		230		μA
Sleep	Input Low Voltage	$EN = Low$			0.5	V

Note 1: Absolute Maximum Ratings are those values beyond which the life of a device may be impaired.

Note 2: Specifications over the $-40^{\circ}C$ to $85^{\circ}C$ temperature range are assured by design, characterization and correlation with statistical process controls.

Note 3: Tests are performed as shown in the configuration of Figure 7.

Note 4: At each of the four baseband inputs BBPI, BBMI, BBPQ and BBMQ.

Note 5: $V_{BBPI} - V_{BBMI} = 1V_{DC}$. $V_{BBPQ} - V_{BBMQ} = 1V_{DC}$.

Note 6: Maximum value within -1dB bandwidth.

Note 7: An external coupling capacitor is used in the RF output line.

Note 8: At 20MHz offset from the LO signal frequency.

Note 9: At 20MHz offset from the CW signal frequency.

Note 10: At 5MHz offset from the CW signal frequency.

Note 11: RF power is within 10% of final value.

Note 12: RF power is at least 30dB lower than in the ON state.

Note 13: Baseband is driven by 2MHz and 2.1MHz tones. Drive level is set in such a way that the two resulting RF tones are -10dBm each.

Note 14: IM2 measured at LO frequency + 4.1MHz

Note 15: IM3 measured at LO frequency + 1.9MHz and LO frequency + 2.2MHz.

Note 16: Amplitude average of the characterization data set without image or LO feedthrough nulling (unadjusted).

Note 17: The difference in conversion gain between the spurious signal at $f = 3 \cdot LO - BB$ versus the conversion gain of the desired signal at $f = LO + BB$ for $BB = 2MHz$ and $LO = 2GHz$.

Note 18: The input voltage corresponding to the output P1dB.

TYPICAL PERFORMANCE CHARACTERISTICS $V_{CC} = 5V$, $EN = High$, $T_A = 25^\circ C$, $f_{LO} = 2.14GHz$, $P_{LO} = 0dBm$. BBPI, BBMI, BBPQ, BBMQ inputs $0.5V_{DC}$, baseband input frequency $f_{BB} = 2MHz$, I and Q 90° shifted, without image or LO feedthrough nulling. $f_{RF} = f_{BB} + f_{LO}$ (upper sideband selection). $P_{RF(OUT)} = -10dBm$ ($-10dBm/tone$ for 2-tone measurements), unless otherwise noted. (Note 3)

Supply Current vs Supply Voltage

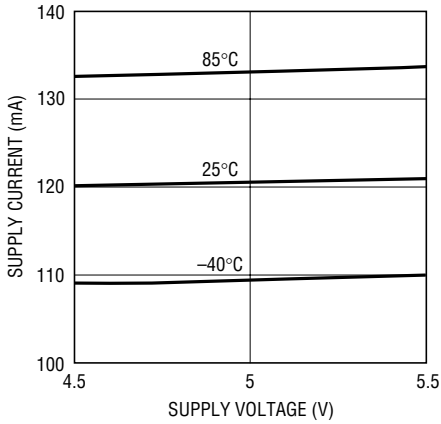

5572 G01

RF Output Power vs LO Frequency at $1V_{P-P}$ Differential Baseband Drive

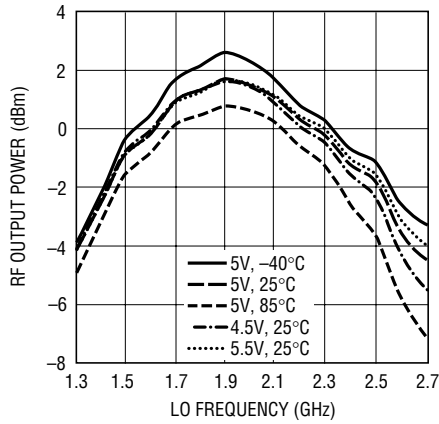

5572 G02

Voltage Gain vs LO Frequency

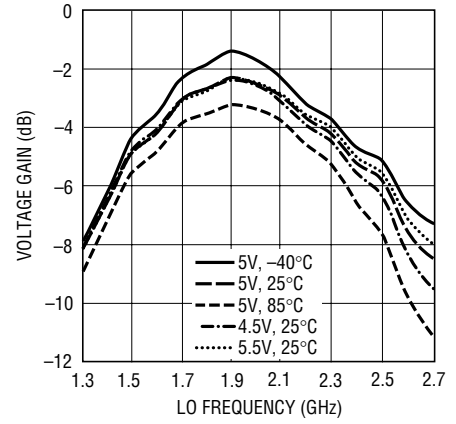

5572 G03

Output IP3 vs LO Frequency

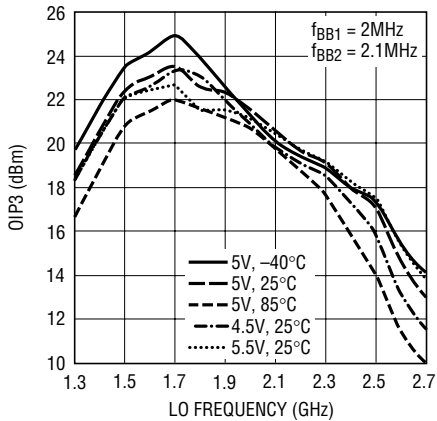

5572 G04

Output IP2 vs LO Frequency

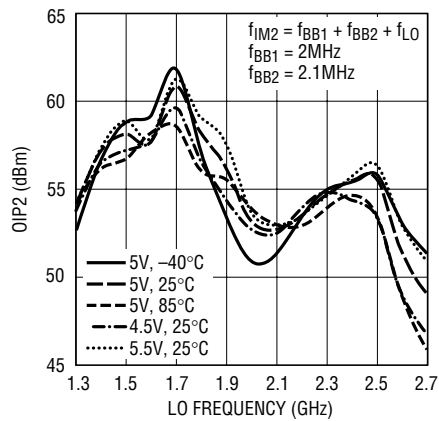

5572 G05

Output 1dB Compression vs LO Frequency

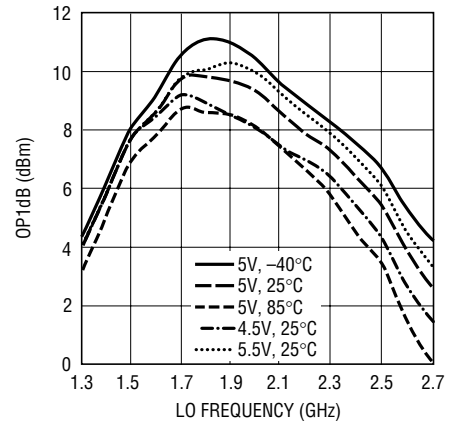

5572 G06

LO Feedthrough to RF Output vs LO Frequency

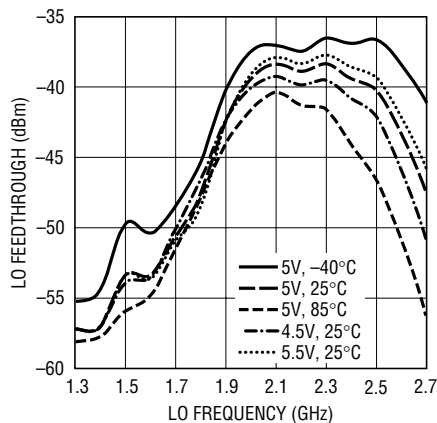

5572 G07

2 • LO Leakage to RF Output vs 2 • LO Frequency

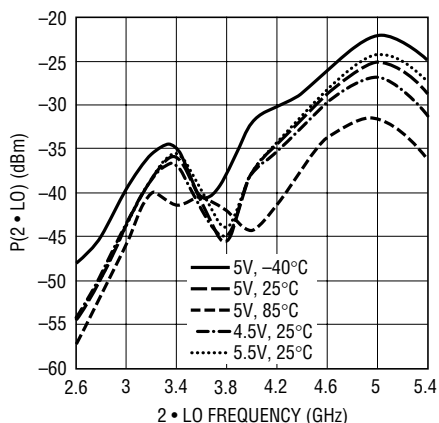

5572 G08

3 • LO Leakage to RF Output vs 3 • LO Frequency

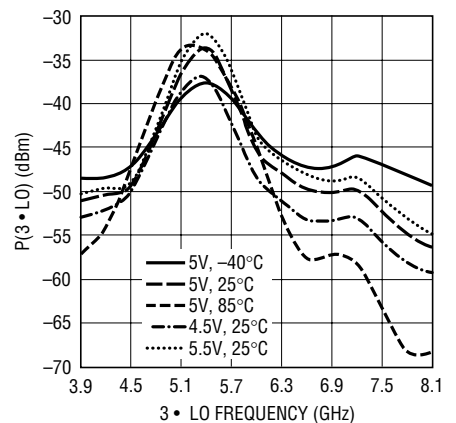

5572 G09

5572f

TYPICAL PERFORMANCE CHARACTERISTICS $V_{CC} = 5V$, $EN = High$, $T_A = 25^\circ C$, $f_{LO} = 2.14GHz$, $P_{LO} = 0dBm$. BBPI, BBMI, BBPQ, BBMQ inputs $0.5V_{DC}$, baseband input frequency $f_{BB} = 2MHz$, I and Q 90° shifted, without image or LO feedthrough nulling. $f_{RF} = f_{BB} + f_{LO}$ (upper sideband selection). $P_{RF(OUT)} = -10dBm$ ($-10dBm/tone$ for 2-tone measurements), unless otherwise noted. (Note 3)

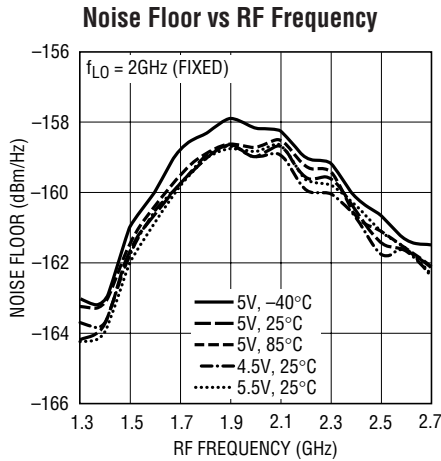

5572 G10

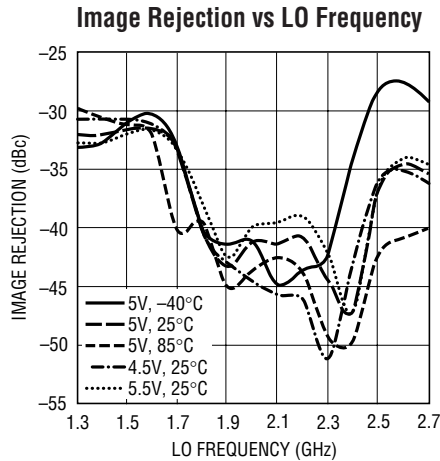

5572 G11

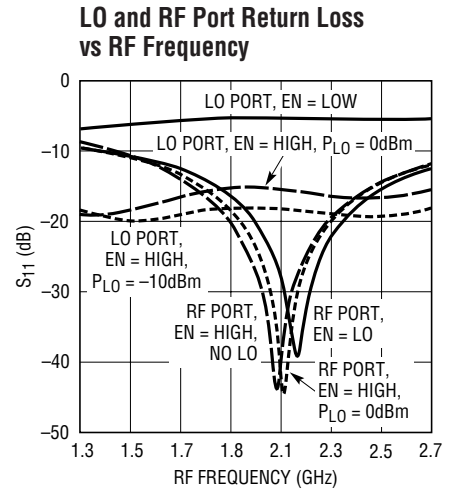

5572 G12

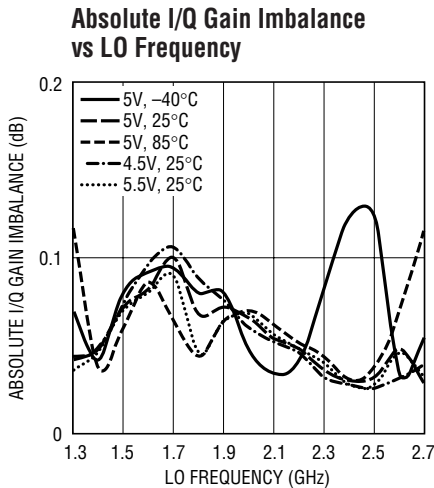

5572 G13

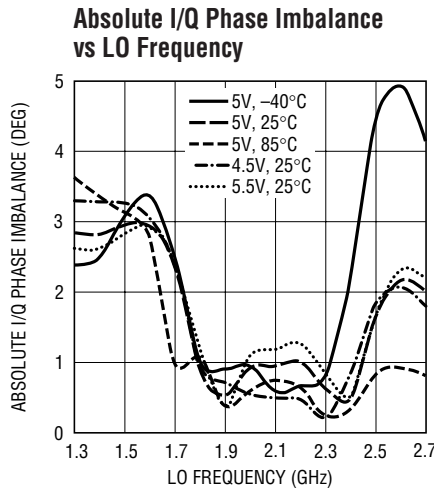

5572 G14

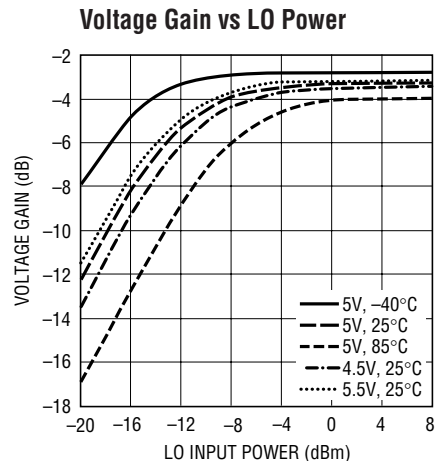

5572 G15

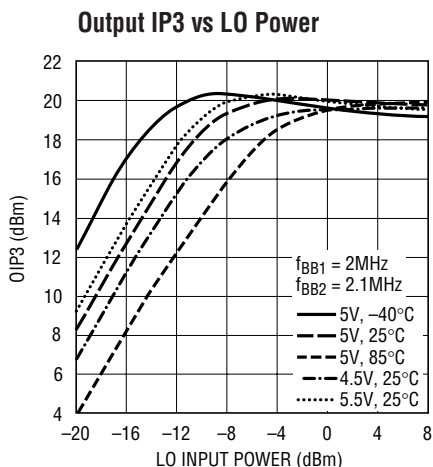

5572 G16

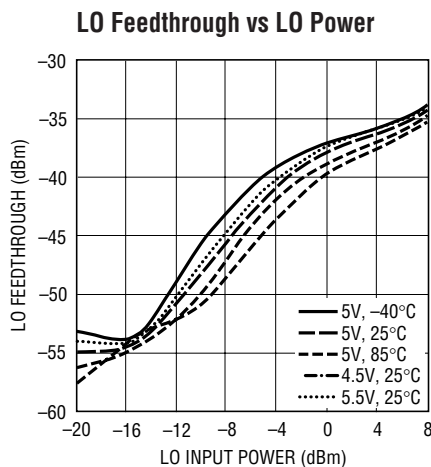

5572 G17

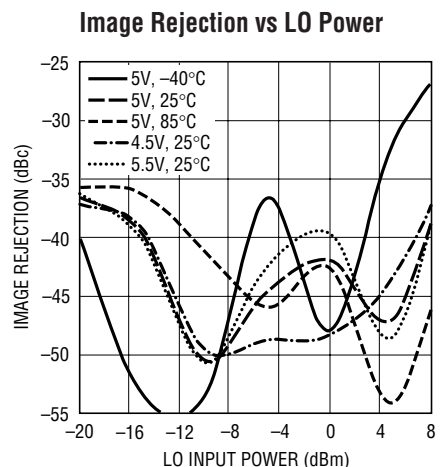

5572 G18

5572f

TYPICAL PERFORMANCE CHARACTERISTICS

$V_{CC} = 5V$, $EN = High$, $T_A = 25^\circ C$, $f_{LO} = 2.14GHz$, $P_{LO} = 0dBm$. BBPI, BBMI, BBPQ, BBMQ inputs $0.5V_{DC}$, baseband input frequency $f_{BB} = 2MHz$, I and Q 90° shifted, without image or LO feedthrough nulling. $f_{RF} = f_{BB} + f_{LO}$ (upper sideband selection). $P_{RF(OUT)} = -10dBm$ ($-10dBm/tone$ for 2-tone measurements), unless otherwise noted. (Note 3)

RF CW Output Power, HD2 and HD3 vs CW Baseband Voltage and Temperature

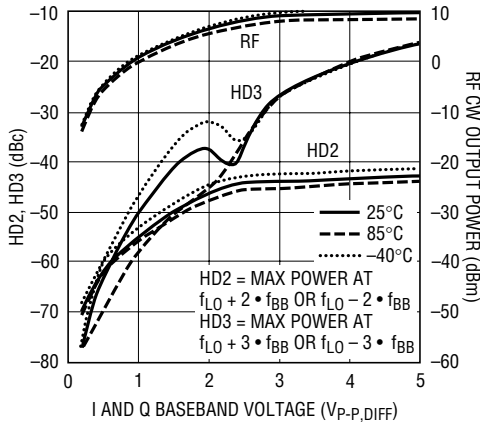

5572 G19

RF CW Output Power, HD2 and HD3 vs CW Baseband and Supply Voltage

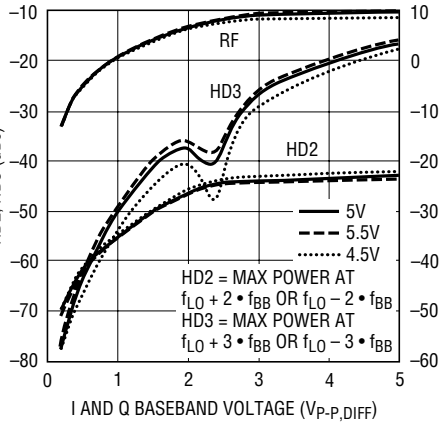

5572 G20

LO Feedthrough to RF Output vs CW Baseband Voltage

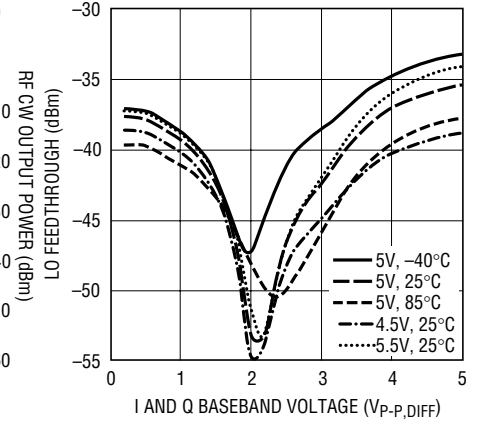

5572 G21

Image Rejection vs CW Baseband Voltage

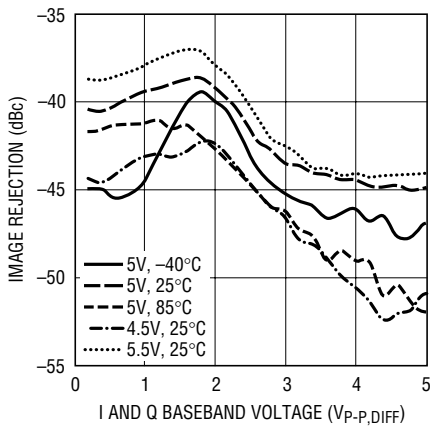

5572 G22

RF 2-Tone Power (Each Tone), IM2 and IM3 vs Baseband Voltage and Temperature

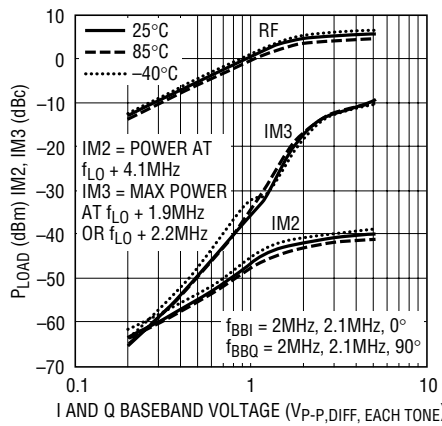

5572 G23

RF 2-Tone Power (Each Tone), IM2 and IM3 vs Baseband and Supply Voltage

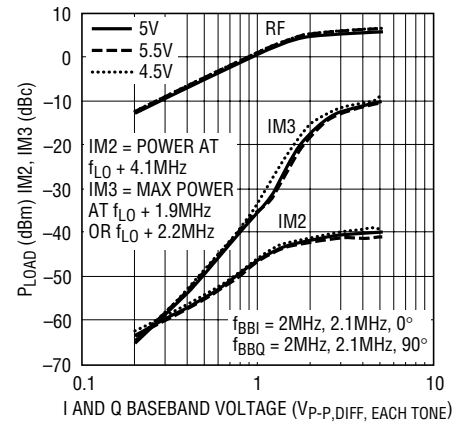

5572 G24

Voltage Gain Distribution

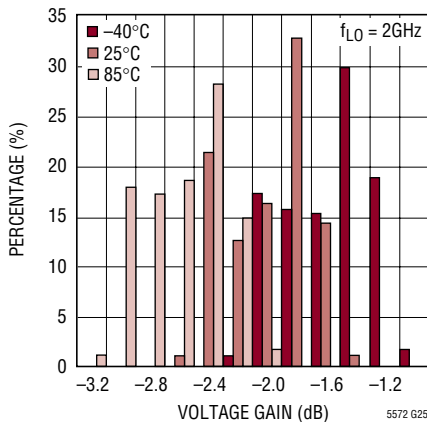

5572 G25

Noise Floor Distribution

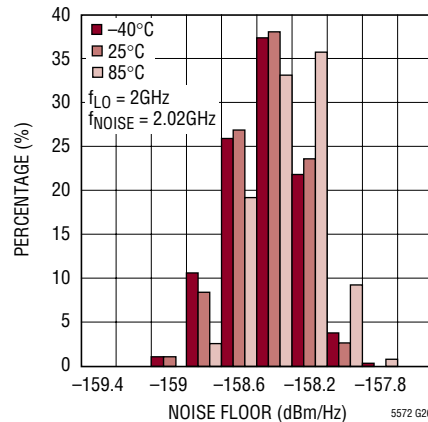

5572 G26

TYPICAL PERFORMANCE CHARACTERISTICS $V_{CC} = 5V$, $EN = High$, $T_A = 25^{\circ}C$, $f_{LO} = 2.14GHz$, $P_{LO} = 0dBm$. $BBPI$, $BBMI$, $BBPQ$, $BBMQ$ inputs $0.5V_{DC}$, baseband input frequency $f_{BB} = 2MHz$, I and Q 90° shifted, without image or LO feedthrough nulling. $f_{RF} = f_{BB} + f_{LO}$ (upper sideband selection). $P_{RF(OUT)} = -10dBm$ ($-10dBm/tone$ for 2-tone measurements), unless otherwise noted. (Note 3)

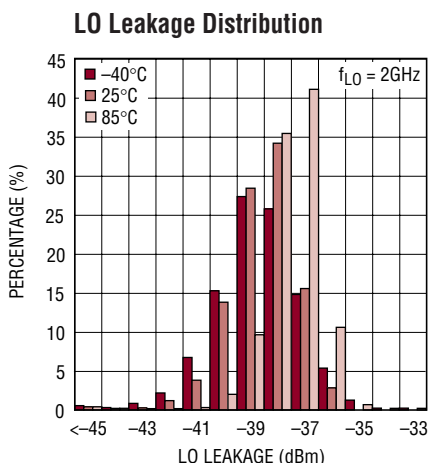

5572 G27

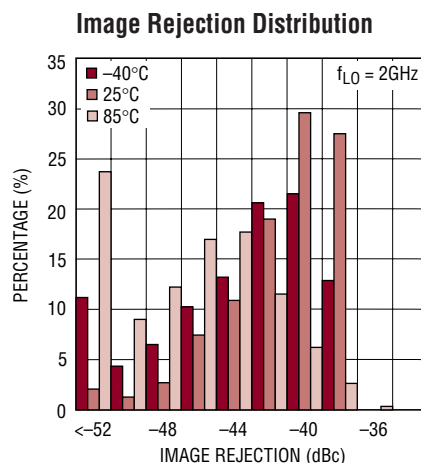

5572 G28

PIN FUNCTIONS

EN (Pin 1): Enable Input. When the EN pin voltage is higher than 1V, the IC is turned on. When the input voltage is less than 0.5V, the IC is turned off.

GND (Pins 2, 4, 6, 9, 10, 12, 15, 17): Ground. Pins 6, 9, 15 and the Exposed Pad, Pin 17, are connected to each other internally. Pins 2 and 4 are connected to each other internally and function as the ground return for the LO signal. Pins 10 and 12 are connected to each other internally and function as the ground return for the on-chip RF balun. For best RF performance, Pins 2, 4, 6, 9, 10, 12, 15 and the Exposed Pad, Pin 17, should be connected to the printed circuit board ground plane.

LO (Pin 3): LO Input. The LO input is an AC-coupled single-ended input with approximately 50Ω input impedance at RF frequencies. Externally applied DC voltage should be within the range $-0.5V$ to $(V_{CC} + 0.5V)$ in order to avoid turning on ESD protection diodes.

BBPQ, BBMQ (Pins 7, 5): Baseband Inputs for the Q channel with about 90kΩ differential input impedance. These pins should be externally biased at about 0.5V. Applied common mode voltage must stay below 0.6V.

V_{CC} (Pins 8, 13): Power Supply. Pins 8 and 13 are connected to each other internally. It is recommended to use 0.1μF capacitors for decoupling to ground on each of these pins.

RF (Pin 11): RF Output. The RF output is an AC-coupled single-ended output with approximately 50Ω output impedance at RF frequencies. Externally applied DC voltage should be within the range $-0.5V$ to $(V_{CC} + 0.5V)$ in order to avoid turning on ESD protection diodes.

BBPI, BBMI (Pins 14, 16): Baseband Inputs for the I channel with about 90kΩ differential input impedance. These pins should be externally biased at about 0.5V. Applied common mode voltage must stay below 0.6V.

BLOCK DIAGRAM

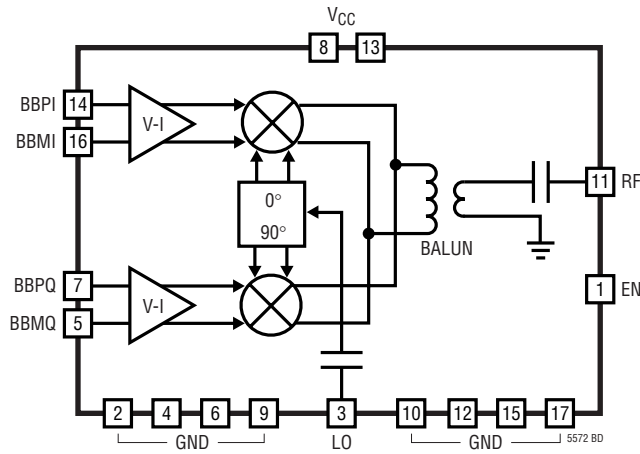

APPLICATIONS INFORMATION

The LT5572 consists of I and Q input differential voltage-to-current converters, I and Q up-conversion mixers, an RF output balun, an LO quadrature phase generator and LO buffers.

External I and Q baseband signals are applied to the differential baseband input pins, BBPI, BBMI, and BBPQ, BBMQ. These voltage signals are converted to currents and translated to RF frequency by means of double-balanced up-converting mixers. The mixer outputs are combined in an RF output balun, which also transforms the output impedance to 50Ω. The center frequency of the resulting RF signal is equal to the LO signal frequency. The LO input drives a phase shifter which splits the LO signal into in-phase and quadrature LO signals. These LO signals are then applied to on-chip buffers which drive the up-conversion mixers. Both the LO input and RF output are single-ended, 50Ω matched and AC coupled.

Baseband Interface

The baseband inputs (BBPI, BBMI) and (BBPQ, BBMQ) present a differential input impedance of about 90kΩ. At each of the four baseband inputs, a capacitor of 1.8pF to ground and a PNP emitter follower is incorporated (see Figure 1), which limits the baseband -1dB bandwidth to approximately 250MHz. The circuit is optimized for an externally applied common mode voltage of 0.5V. The baseband input pins should not be left floating because

the internal PNP's base current will pull the common mode voltage higher than the 0.6V limit. This may damage the part if continued indefinitely. The PNP's base current is about 20μA in normal operation. On the LT5572 demo board, external 50Ω resistors to ground are included at each baseband input to prevent this condition and to serve as a termination resistance for the baseband connections.

The I/Q input signals to the LT5572 should be DC coupled with an applied common mode voltage level of about 0.5V in order to bias the LT5572 at its optimum operating point. Some I/Q test generators allow setting the common mode voltage independently. In this case, the common mode voltage of those generators must be set to 0.5V (See Figure 2).

The baseband inputs should be driven differentially; otherwise, the even-order distortion products will degrade the overall linearity severely. Typically, a DAC will be the signal source for the LT5572. Reconstruction filters should be placed between the DAC outputs and the LT5572's baseband inputs.

In Figure 3, a typical baseband interface is shown including a 5th-order lowpass ladder filter for reconstruction. For each baseband pin, a 0V to 1V swing is developed corresponding to a DAC output current of 0mA to 20mA. The maximum sinusoidal single sideband RF output power at 2.14GHz is about +6.2dBm for full 0V to 1V swing on each baseband

APPLICATIONS INFORMATION

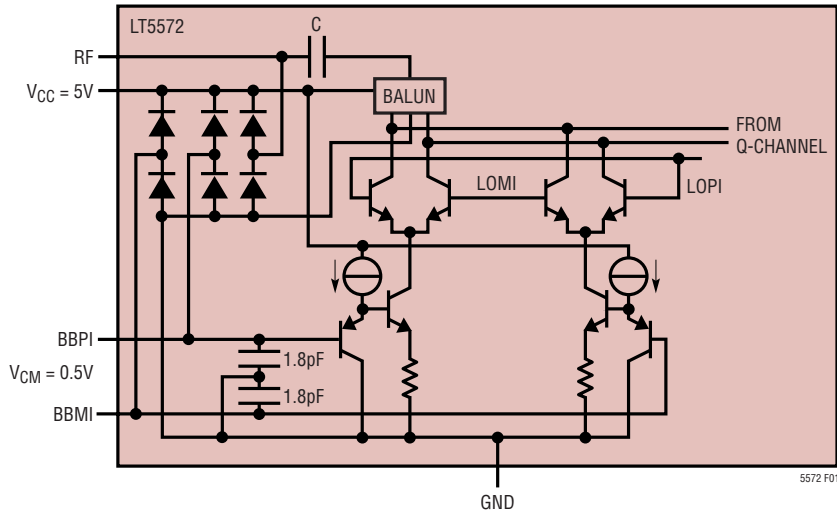

Figure 1. Simplified Circuit Schematic of the LT5572 (Only I Channel is Drawn)

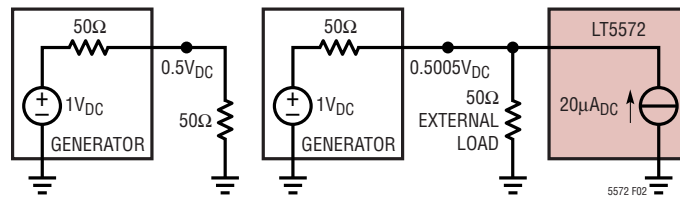

Figure 2. DC Voltage Levels for a Generator Programmed at $0.5V_{DC}$ for a 50Ω Load Without and With the LT5572 as a Load

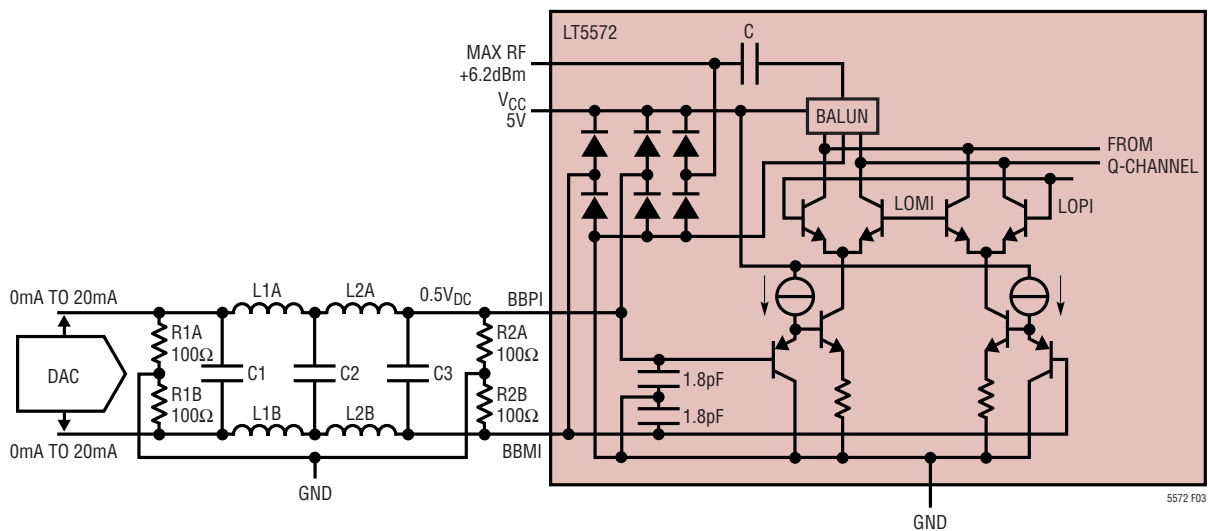

Figure 3. LT5572 Baseband Interface with 5th Order Filter and $0.5V_{CM}$ DAC (Only I Channel is Shown)

APPLICATIONS INFORMATION

Table 1. Typical Performance Characteristics vs V_{CM} for $f_{LO} = 2\text{GHz}$, $P_{LO} = 0\text{dBm}$

V_{CM} (V)	I_{CC} (mA)	G_V (dB)	OP1dB (dBm)	OIP2 (dBm)	OIP3 (dBm)	NFloor (dBm/Hz)	LOFT (dBm)	IR (dBc)
0.1	77	-1.3	0.0	47	8.3	-163.2	-45.6	-42.2
0.2	89	-2.7	4.7	45	11.4	-162.2	-42.6	-36.2
0.3	101	-2.1	7.1	49	15.0	-160.9	-42.0	-37.0
0.4	113	-2.0	8.6	51	18.2	-160.2	-42.4	-39.3
0.5	126	-1.9	9.3	52	21.2	-159.2	-42.4	-41.5
0.6	138	-1.9	9.1	52	21.1	-158.6	-42.1	-44.4

input ($2V_{P-P,DIFF}$). This maximum RF output level is limited by the $0.5V_{PEAK}$ maximum baseband swing possible for a $0.5V_{DC}$ common mode voltage level (assuming no extra negative supply voltage available).

It is possible to bias the LT5572 to a common mode baseband voltage level other than 0.5V. Table 1 shows the typical performance for different common mode voltages.

LO section

The internal LO input amplifier performs single-ended to differential conversion of the LO input signal. Figure 4 shows the equivalent circuit schematic of the LO input.

The internal, differential LO signal is split into in-phase and quadrature (90° phase shifted) signals that drive LO buffer sections. These buffers drive the double balanced I and Q mixers. The phase relationship between the LO input and the internal in-phase LO and quadrature LO signals is fixed, and is independent of start-up conditions. The phase shifters are designed to deliver accurate quadrature signals for an LO frequency near 2GHz. For frequencies significantly below 1.8GHz or above 2.4GHz, the quadrature accuracy will diminish, causing the image rejection

to degrade. The LO pin input impedance is about 50Ω and the recommended LO input power is 0dBm. For lower LO input power, the gain, OIP2, OIP3 and dynamic range will degrade, especially below -5dBm and at $T_A = 85^\circ\text{C}$. For high LO input power (e.g., 5dBm), the LO feedthrough will increase, without improvement in linearity or gain. Harmonics present on the LO signal can degrade the image rejection, because they introduce a small excess phase shift in the internal phase splitter. For the second (at 4GHz) and third harmonics (at 6GHz) at -20dBc level, the introduced signal at the image frequency is about -57dBc or lower, corresponding to an excess phase shift much less than 1 degree. For the second and third harmonics at -10dBc , still the introduced signal at the image frequency is about -47dBc . Higher harmonics than the third will have less impact. The LO return loss typically will be better than 14dB over the 1.7GHz to 2.4GHz range. Table 2 shows the LO port input impedance vs frequency.

Table 2. LO Port Input Impedance vs Frequency for EN = High and $P_{LO} = 0\text{dBm}$

FREQUENCY (MHz)	INPUT IMPEDANCE (Ω)	S_{11}	
		Mag	Angle
1000	45.9+j15.7	0.167	95
1400	60.8+j2.1	0.099	9.4
1600	63.2-j6.0	0.128	-22
1800	61.8-j14.2	0.163	-44
2000	56.4-j16.8	0.165	-61
2200	51.7-j14.7	0.144	-75
2400	47.3-j11.3	0.119	-97
2600	42.5-j8.6	0.122	-126

The input impedance of the LO port is different if the part is in shutdown mode. The LO input impedance for EN = Low is given in Table 3.

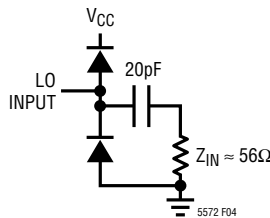

Figure 4. Equivalent Circuit Schematic of the LO Input

APPLICATIONS INFORMATION

Table 3. LO Port Input Impedance vs Frequency for EN = Low and $P_{LO} = 0\text{dBm}$

FREQUENCY (MHz)	INPUT IMPEDANCE (Ω)	S_{11}	
		Mag	Angle
1000	51.2+j45.6	0.409	64
1400	133-j11.8	0.456	-4.5
1600	97.8-j65.8	0.502	-30
1800	58.6-j67.8	0.534	-51
2000	39.0-j55.6	0.540	-69
2200	29.6-j43.2	0.527	-87
2400	23.7-j30.8	0.506	-108
2600	19.7-j20.5	0.503	-130

RF Section

After up-conversion, the RF outputs of the I and Q mixers are combined. An on-chip balun performs internal differential to single-ended output conversion, while transforming the output signal impedance to 50Ω . Table 4 shows the RF port output impedance vs frequency.

Table 4. RF Port Output Impedance vs Frequency for EN = High and $P_{LO} = 0\text{dBm}$

FREQUENCY (MHz)	OUTPUT IMPEDANCE (Ω)	S_{22}	
		Mag	Angle
1000	20.7+j9.9	0.434	153
1400	32.2+j20.3	0.319	117
1600	44.9+j21.8	0.230	90
1800	56.4+j12.2	0.129	56
2000	52.6+j0.5	0.025	10
2200	43.0+j0.5	0.075	176
2400	36.8+j5.6	0.164	153
2600	32.9+j11.0	0.243	140

The RF output S_{22} with no LO power applied is given in Table 5.

Table 5. RF Port Output Impedance vs Frequency for EN = High and No LO Power Applied

FREQUENCY (MHz)	OUTPUT IMPEDANCE (Ω)	S_{22}	
		Mag	Angle
1000	21.2+j10.1	0.424	153
1400	35.3+j18.4	0.270	117
1600	46.1+j14.1	0.150	97
1800	47.4+j5.0	0.057	114
2000	42.0+j3.0	0.093	157
2200	37.5+j6.8	0.162	147
2400	34.8+j11.8	0.224	134
2600	32.8+j16.1	0.279	126

For EN = Low the S_{22} is given in Table 6.

Table 6. RF Port Output Impedance vs Frequency for EN = Low

FREQUENCY (MHz)	OUTPUT IMPEDANCE (Ω)	S_{22}	
		Mag	Angle
1000	20.3+j9.7	0.440	154
1400	30.6+j20.2	0.338	120
1600	41.8+j23.6	0.264	95
1800	55.6+j18.5	0.181	63
2000	58.3+j49.1	0.089	28
2200	48.8-j0.1	0.012	-172
2400	40.4+j3.1	0.112	160
2600	34.7+j8.3	0.205	146

To improve S_{22} for lower frequencies, a shunt capacitor can be added to the RF output. At higher frequencies, a shunt inductor can improve the S_{22} . Figure 5 shows the equivalent circuit schematic of the RF output.

Note that an ESD diode is connected internally from the RF output to ground. For strong output RF signal levels (higher than 3dBm) this ESD diode can degrade the linearity performance if the 50Ω termination impedance is connected directly to ground. To prevent this, a coupling capacitor can be inserted in the RF output line. This is strongly recommended for 1dB compression measurements.

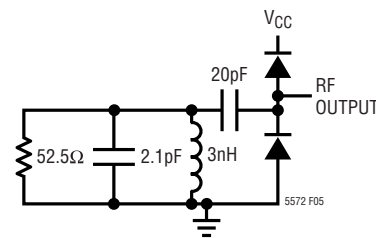

Figure 5. Equivalent Circuit Schematic of the RF Output

Enable Interface

Figure 6 shows a simplified schematic of the EN pin interface. The voltage necessary to turn on the LT5572 is 1V . To disable (shut down) the chip, the enable voltage must be below 0.5V . If the EN pin is not connected, the chip is disabled. This EN = Low condition is guaranteed by the 75k on-chip pull-down resistor. It is important that the voltage at the EN pin does not exceed V_{CC} by more than 0.5V . If this should occur, the full-chip supply

APPLICATIONS INFORMATION

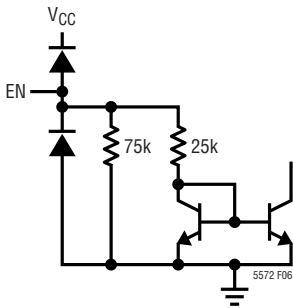

Figure 6. EN Pin Interface

current could be sourced through the EN pin ESD protection diodes, which are not designed for this purpose. Damage to the chip may result.

Evaluation Board

Figure 7 shows the evaluation board schematic. A good ground connection is required for the Exposed Pad. If this is not done properly, the RF performance will degrade. Additionally, the Exposed Pad provides heat sinking for the part and minimizes the possibility of the chip overheating. R1 (optional) limits the EN pin current in the

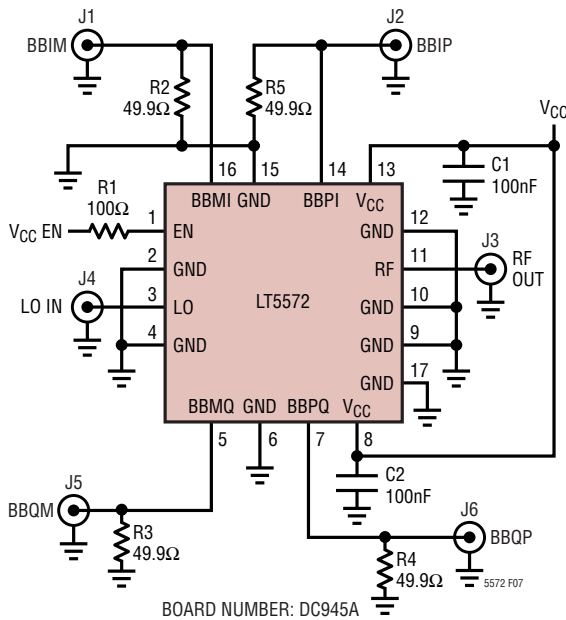

Figure 7. Evaluation Circuit Schematic

event that the EN pin is pulled high while the V_{CC} inputs are low. The application board PCB layouts are shown in Figures 8 and 9.

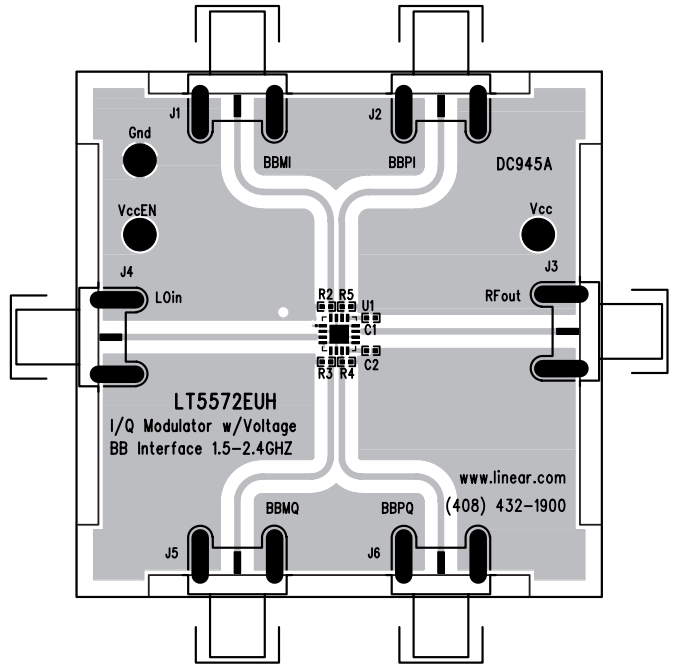

Figure 8. Component Side of Evaluation Board

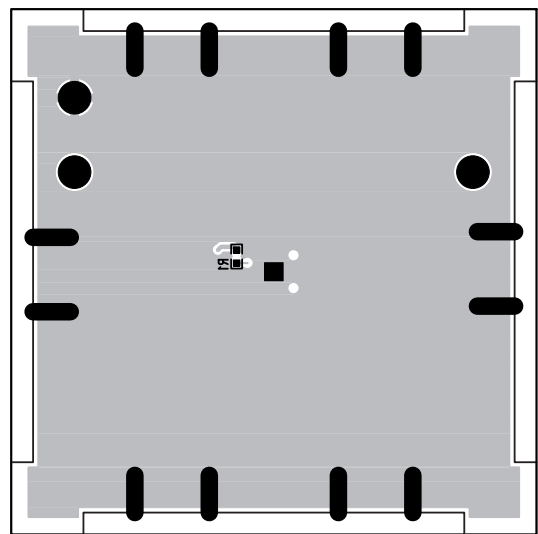

Figure 9. Bottom Side of Evaluation Board

APPLICATIONS INFORMATION

Application Measurements

The LT5572 is recommended for basestation applications using various modulation formats. Figure 10 shows a typical application. Figure 11 shows the ACPR performance for W-CDMA using 1-, 2- or 4-channel modulation. Figures 12, 13 and 14 illustrate the 1-, 2- and 4-channel W-CDMA

measurement. To calculate ACPR, a correction is made for the spectrum analyzer noise floor (Application Note 99).

If the output power is high, the ACPR will be limited by the linearity performance of the part. If the output power is low, the ACPR will be limited by the noise performance of the part. In the middle, an optimum ACPR is obtained.

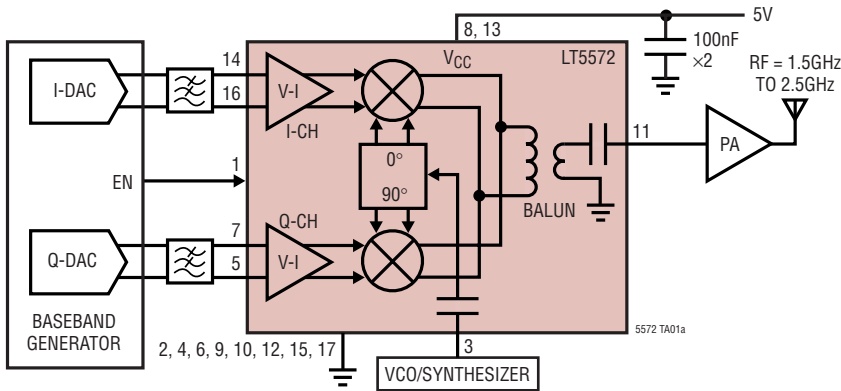

Figure 10. 1.5GHz to 2.4GHz Direct Conversion Transmitter Application

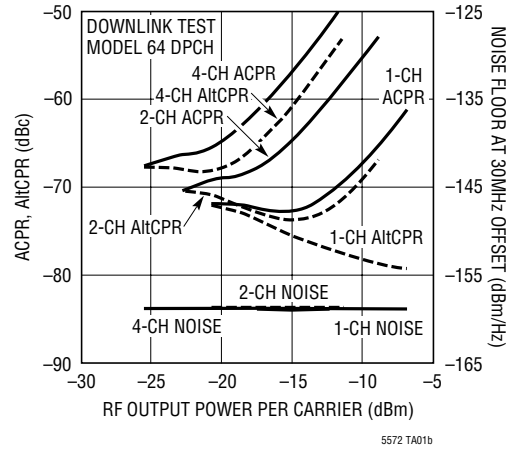

Figure 11. W-CDMA ACPR, ALTCPR and Noise vs RF Output Power at 2140MHz for 1, 2 and 4 Channels

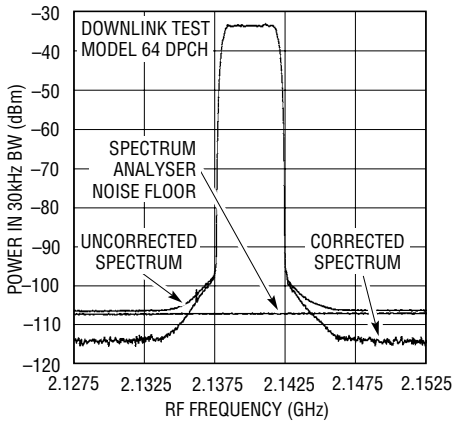

Figure 12. 1-Channel W-CDMA Spectrum

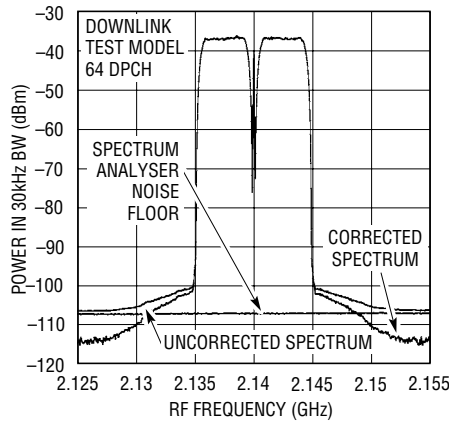

Figure 13. 2-Channel W-CDMA Spectrum

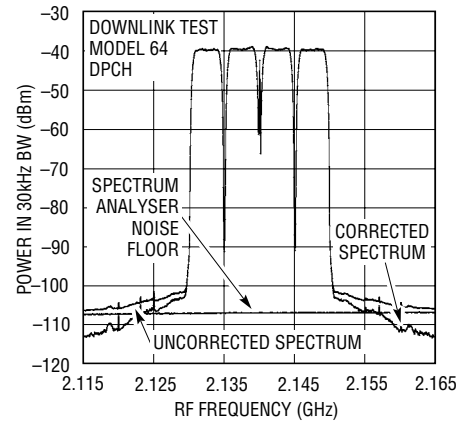

Figure 14. 4-Channel W-CDMA Spectrum

APPLICATIONS INFORMATION

Because of the LT5572’s very high dynamic range, the test equipment can limit the accuracy of the ACPR measurement. Consult the factory for advice on the ACPR measurement if needed.

The ACPR performance is sensitive to the amplitude match of the BBIP and BBIM (or BBQP and BBQM) input voltage. This is because a difference in AC voltage amplitude will give rise to a difference in amplitude between the even-order harmonic products generated in the internal V-I converter.

As a result, they will not cancel out entirely. Therefore, it is important to keep the amplitudes at the BBIP and BBIM (or BBQP and BBQM) inputs as equal as possible.

When the temperature is changed after calibration, the LO feedthrough and the image rejection performance will change. This is illustrated in Figure 15. The LO feedthrough and image rejection can also change as a function of the baseband drive level as depicted in Figure 16.

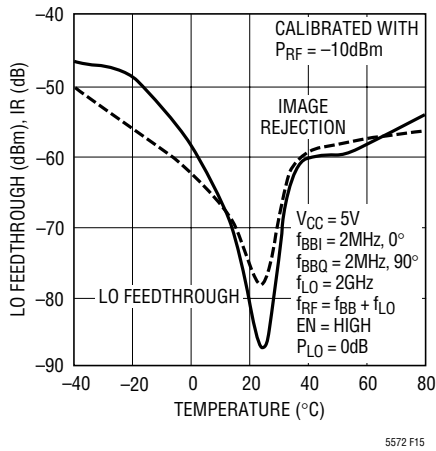

Figure 15. LO Feedthrough and Image Rejection vs Temperature After Calibration at 25°C

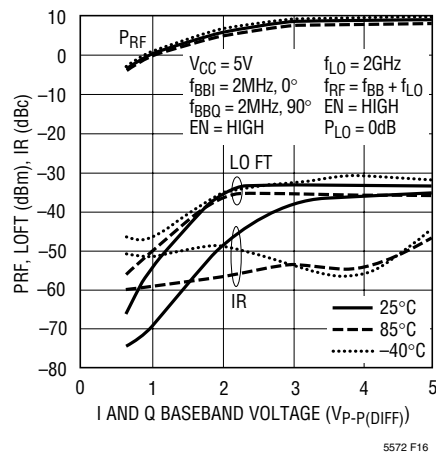
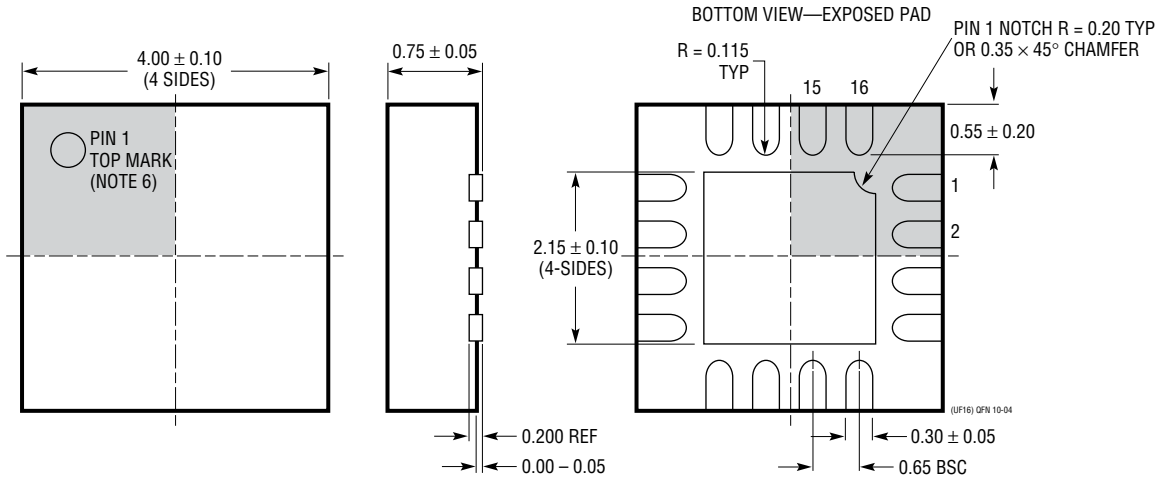
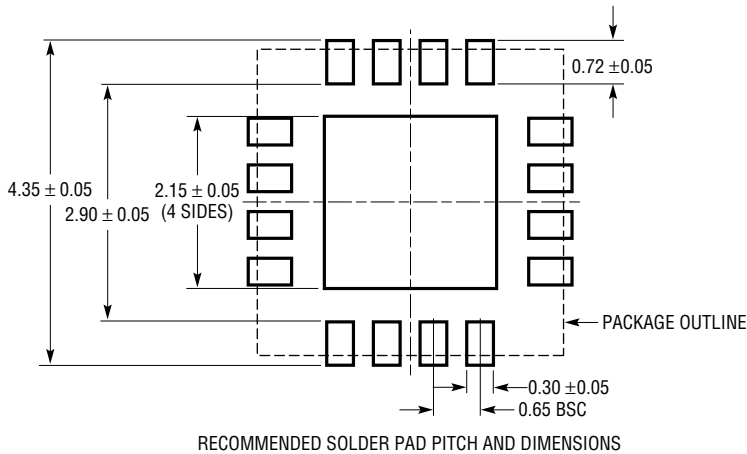

Figure 16. RF Output Power, Image Rejection and LO Feedthrough vs Baseband Drive Voltage After Calibration at 25°C

PACKAGE DESCRIPTION

UF Package
16-Lead Plastic QFN (4mm × 4mm)
 (Reference LTC DWG # 05-08-1692)



1. DRAWING CONFORMS TO JEDEC PACKAGE OUTLINE MO-220 VARIATION (WGGC)
2. DRAWING NOT TO SCALE
3. ALL DIMENSIONS ARE IN MILLIMETERS
4. DIMENSIONS OF EXPOSED PAD ON BOTTOM OF PACKAGE DO NOT INCLUDE MOLD FLASH. MOLD FLASH, IF PRESENT, SHALL NOT EXCEED 0.15mm ON ANY SIDE
5. EXPOSED PAD SHALL BE SOLDER PLATED
6. SHADED AREA IS ONLY A REFERENCE FOR PIN 1 LOCATION ON THE TOP AND BOTTOM OF PACKAGE

RELATED PARTS

PART NUMBER	DESCRIPTION	COMMENTS
Infrastructure		
LT5511	High Linearity Upconverting Mixer	RF Output to 3GHz, 17dBm IIP3, Integrated LO Buffer
LT5512	DC to 3GHz High Signal Level Downconverting Mixer	DC to 3GHz, 17dBm IIP3, Integrated LO Buffer
LT5514	Ultralow Distortion, IF Amplifier/ADC Driver with Digitally Controlled Gain	850MHz Bandwidth, 47dBm OIP3 at 100MHz, 10.5dB to 33dB Gain Control Range
LT5515	1.5GHz to 2.5GHz Direct Conversion Quadrature Demodulator	20dBm IIP3, Integrated LO Quadrature Generator
LT5516	0.8GHz to 1.5GHz Direct Conversion Quadrature Demodulator	21.5dBm IIP3, Integrated LO Quadrature Generator
LT5517	40MHz to 900MHz Quadrature Demodulator	21dBm IIP3, Integrated LO Quadrature Generator
LT5518	1.5GHz to 2.4GHz High Linearity Direct Quadrature Modulator	22.8dBm OIP3 at 2GHz, -158.2dBm/Hz Noise Floor, 50Ω Single-Ended RF and LO Ports, 4-Channel W-CDMA ACPR = -64dBc at 2.14GHz
LT5519	0.7GHz to 1.4GHz High Linearity Upconverting Mixer	17.1dBm IIP3 at 1GHz, Integrated RF Output Transformer with 50Ω Matching, Single-Ended LO and RF Ports Operation
LT5520	1.3GHz to 2.3GHz High Linearity Upconverting Mixer	15.9dBm IIP3 at 1.9GHz, Integrated RF Output Transformer with 50Ω Matching, Single-Ended LO and RF Ports Operation
LT5521	10MHz to 3700MHz High Linearity Upconverting Mixer	24.2dBm IIP3 at 1.95GHz, NF = 12.5dB, 3.15V to 5.25V Supply, Single-Ended LO Port Operation
LT5522	600MHz to 2.7GHz High Signal Level Downconverting Mixer	4.5V to 5.25V Supply, 25dBm IIP3 at 900MHz, NF = 12.5dB, 50Ω Single-Ended RF and LO Ports
LT5524	Low Power, Low Distortion ADC Driver with Digitally Programmable Gain	450MHz Bandwidth, 40dBm OIP3, 4.5dB to 27dB Gain Control
LT5525	High Linearity, Low Power Downconverting Mixer	Single-Ended 50Ω RF and LO Ports, 17.6dBm IIP3 at 1900MHz, I _{CC} = 28mA
LT5526	High Linearity, Low Power Downconverting Mixer	3V to 5.3V Supply, 16.5dBm IIP3, 100kHz to 2GHz RF, NF = 11dB, I _{CC} = 28mA, -65dBm LO-RF Leakage
LT5527	400MHz to 3.7GHz High Signal Level Downconverting Mixer	IIP3 = 23.5dBm and NF = 12.5dBm at 1900MHz, 4.5V to 5.25V Supply, I _{CC} = 78mA
LT5528	1.5GHz to 2.4GHz High Linearity Direct Quadrature Modulator	21.8dBm OIP3 at 2GHz, -159.3dBm/Hz Noise Floor, 50Ω, 0.5V _{DC} Baseband Interface, 4-Channel W-CDMA ACPR = -66dBc at 2.14GHz
RF Power Detectors		
LTC®5505	RF Power Detectors with >40dB Dynamic Range	300MHz to 3GHz, Temperature Compensated, 2.7V to 6V Supply
LTC5507	100kHz to 1000MHz RF Power Detector	100kHz to 1GHz, Temperature Compensated, 2.7V to 6V Supply
LTC5508	300MHz to 7GHz RF Power Detector	44dB Dynamic Range, Temperature Compensated, SC70 Package
LTC5509	300MHz to 3GHz RF Power Detector	36dB Dynamic Range, Low Power Consumption, SC70 Package
LTC5530	300MHz to 7GHz Precision RF Power Detector	Precision V _{OUT} Offset Control, Shutdown, Adjustable Gain
LTC5531	300MHz to 7GHz Precision RF Power Detector	Precision V _{OUT} Offset Control, Shutdown, Adjustable Offset
LTC5532	300MHz to 7GHz Precision RF Power Detector	Precision V _{OUT} Offset Control, Adjustable Gain and Offset
LT5534	50MHz to 3GHz Log RF Power Detector with 60dB Dynamic Range	±1dB Output Variation over Temperature, 38ns Response Time, Log Linear Response
LTC5536	Precision 600MHz to 7GHz RF Power Detector with Fast Comparator Output	25ns Response Time, Comparator Reference Input, Latch Enable Input, -26dBm to +12dBm Input Range
LT5537	Wide Dynamic Range Log RF/IF Detector	Low Frequency to 1GHz, 83dB Dynamic Range, 2.7V to 5.25V Supply
High Speed ADCs		
LTC2220-1	12-Bit, 185Msps ADC	Single 3.3V Supply, 910mW Consumption, 67.5dB SNR, 80dB SFDR, 775MHz Full Power BW
LTC2249	14-Bit, 80Msps ADC	Single 3V Supply, 222mW Consumption, 73dB SNR, 90dB SFDR
LTC2255	14-Bit, 125Msps ADC	Single 3V Supply, 395mW Consumption, 72.4dB SNR, 88dB SFDR, 640MHz Full Power BW

Mouser Electronics

Authorized Distributor

Click to View Pricing, Inventory, Delivery & Lifecycle Information:

[Analog Devices Inc.:](#)

[LT5572EUF#TR](#) [LT5572EUF#TRPBF](#) [LT5572EUF#PBF](#) [LT5572EUF](#)