

Evaluates: ADPL42001

General Description

The ADPL42001 evaluation kit (EV kit) is a fully assembled and tested circuit board that demonstrates the performance of the ADPL42001 high-voltage, ultra-low quiescent current linear regulator. The EV kit operates over a wide input voltage range of 4V to 20V and provides up to 100mA load current. It draws only 8 μ A supply current under no-load conditions. The device is simple to use and easily configurable with minimal external components. It features overload current protection and thermal shutdown.

The EV kit consists of two circuits: one circuit is installed with the ADPL42001AZT+ in a 6-pin, compact TSOT package. The second circuit is installed with the ADPL42001ATT+ in a 6-pin, (3mm x 3mm) TDFN package.

Features and Benefits

- Wide 4V to 20V Input Voltage Range
 - Jumper Configurable 12V, 5V, and 3.3V Outputs
 - Up to 100mA Load Current Capability
 - 8 μ A No-Load Supply Current
 - Active-High, Enable Input
 - PGOOD Output for Regulator Output Voltage Monitoring
 - Overload Protection
 - Overtemperature Protection
 - Proven PCB Layout
- Fully Assembled and Tested

Ordering Information appears at end of data sheet.

Quick Start

Required Equipment

- ADPL42001EVKIT# EV kit
- 20V, 0.2A DC power supply
- Electronic load up to 100mA
- Digital voltmeter (DVM)

Procedure

The EV kit is fully assembled and tested. Follow the steps below to verify board operation.

Caution: Do not turn on the power supply until all connections are completed.

1. Verify that shunts are installed between pins 1 and 2 of jumper JU101 and JU201 (EN).
2. Place a shunt on JU102 or JU103, JU202 or JU203 depending on the desired output voltage (see [Table 2](#) for details).
3. Set the electronic load to constant-current mode, 100mA, and disable the electronic load.
4. Connect the electronic load's positive terminal to the V_{OUT} PCB pad. Connect the negative terminal to the GND PCB pad.
5. Connect the voltmeter across the V_{OUT} and GND PCB pads.
6. Set the power-supply output to greater than the selected output voltage. Disable the power supply.
7. Connect the power-supply output to the V_{IN} PCB pad. Connect the supply ground to the GND PCB pad.
8. Turn on the power supply.
9. Enable the electronic load and verify that output voltage is at 3.3V or 5V with respect to GND.
10. Vary the input voltage from 4V to 20V.
11. Vary the load current from 1mA to available maximum load current (from thermal dissipation calculation, see the [Available Output Current Calculation](#) section for more details) and verify that output voltage is 3.3V or 5V with respect to GND.

ADPL42001 EV Kit Board Configuration

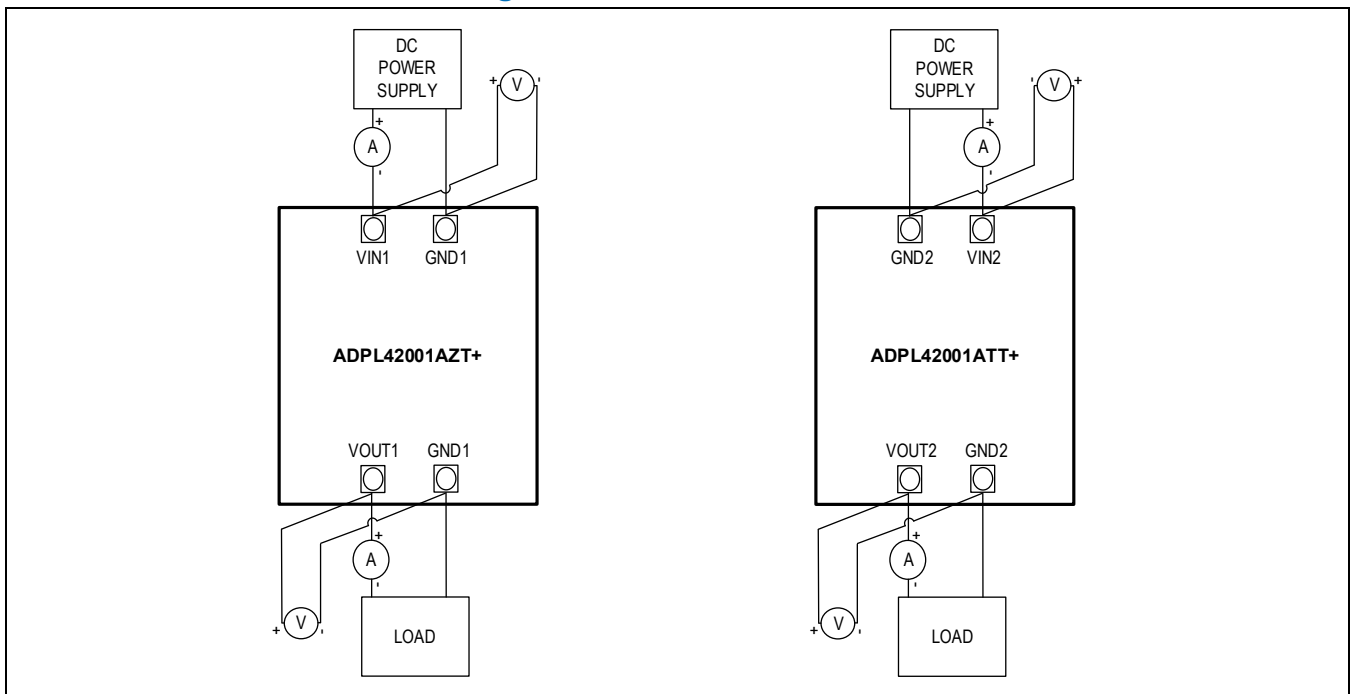

Figure 1. ADPL42001 EV Kit Connections

Detailed Description of Hardware

The ADPL42001EVKIT# is a fully assembled and tested circuit board that demonstrates the performance of the ADPL42001 high-voltage, ultra-low quiescent current linear regulator. The EV kit operates over a wide input-voltage range of 4V to 20V and provides up to 100mA load current. It draws only 8μA supply current under no-load conditions. The EV kit is simple to use and easily configurable with minimal external components. It features overload current protection and thermal shutdown.

The EV kit includes an EN PCB pad and JU101, JU201 to enable control of the converter output. Jumpers JU102, JU202 and JU103, JU203 are provided for selecting the output voltage of the converter. PGOOD PCB pad is available for monitoring the PGOOD output.

Enable Control (JU101, JU201)

The EN PCB pad of the EV kit serves as an on/off control. See [Table 1](#) to configure JU101 or JU201.

Table 1. Enable Control (EN)

JU101 AND JU201 SHUNT POSITION	EN PIN	OUTPUT
1-2*	Connected to VIN	Enabled
2-3	Connected to GND	Disabled

*Default position.

Active-Low, Open-Drain PGOOD Output (PGOOD)

The EV kit provides a PCB pad to monitor the status of the PGOOD output. PGOOD goes high when the output voltage rises above 92% (typ) of its nominal regulated output voltage. PGOOD goes low when the output voltage falls below 89.5% (typ) of its nominal regulated voltage. The voltage on the PGOOD pin should not exceed 5V. If the output voltage is greater than 5V, calculate the value of resistance R106 or R206 from the following equation:

$$R206 = \frac{500}{V_{OUT}-5} k\Omega$$

Output Voltage Setting

The output voltage can be programmed from 0.6V to 19V. If the output voltage is neither 5V or 3.3V, calculate the value of R104 or R204 using the following equation. Place a shunt on one of JU102 or JU202, JU103 or JU203, and JU104 or JU204, according to [Table 2](#).

$$R204 = 98.3 \times (V_{OUT} - 0.6)k\Omega$$

Table 2. Output Voltage

OUTPUT VOLTAGE	PLACE SHUNT ON
$V_{OUT} = 5V$	JU102, JU202*
$V_{OUT} = 3.3V$	JU103, JU203
User Programmable	JU104
$V_{OUT} = 12V$	JU204

*Default position.

Output Capacitor Selection

The voltage rating of the output capacitor installed on the board C103 is 10V and C203 is 16V. If the programmed output voltage is greater than 10V or 16V, an output capacitor with a higher voltage rating should be installed.

Available Output Current Calculation

Ensure that the junction temperature of the ADPL42001 does not exceed +125°C under the operating conditions specified for the power supply.

At a particular operating condition, the power loss that led to the temperature rise of the part is estimated as follows:

$$P_{LOSS} = (V_{IN} - V_{OUT}) \times I_{LOAD}$$

where, V_{IN} is the input voltage, V_{OUT} is the output voltage, and I_{LOAD} is the load current.

ADPL42001ATT+ Package thermal resistance measured on the ADPL42001EVKIT# EV kit with no airflow is:

$$\theta_{JA} = 42^{\circ}C/W$$

ADPL42001AZT+ Package thermal resistance measured on the ADPL42001EVKIT# EV kit with no airflow is:

$$\theta_{JA} = 110^{\circ}C/W$$

The junction temperature of the ADPL42001 can be estimated at any given maximum ambient temperature (T_{A_MAX}) from the equation below:

$$T_j = T_{A_MAX} + (\theta_{JA} \times P_{LOSS})$$

Calculate the maximum allowable output current in mA using the following formula:

$$I_{LOAD(MAX)} = \frac{(125 - T_{A_MAX})}{\theta_{JA} \times (V_{IN} - V_{OUT})}$$

Example: $T_{A_MAX} = +70^{\circ}C$, $V_{IN} = 24V$, $V_{OUT} = 5V$.

$$I_{LOAD(MAX)} = \frac{(125-70)}{0.042 \times (24-5)} \cong 69mA$$

EV Kit Performance

($V_{IN} = 7V$, $T_A = +25^{\circ}C$, unless otherwise noted.)

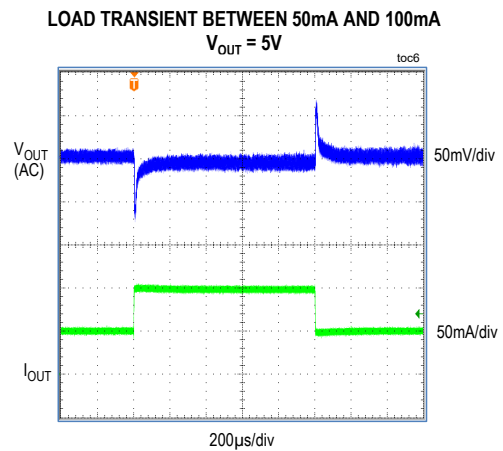
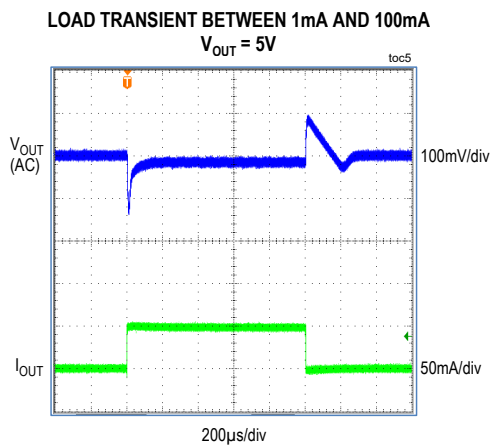
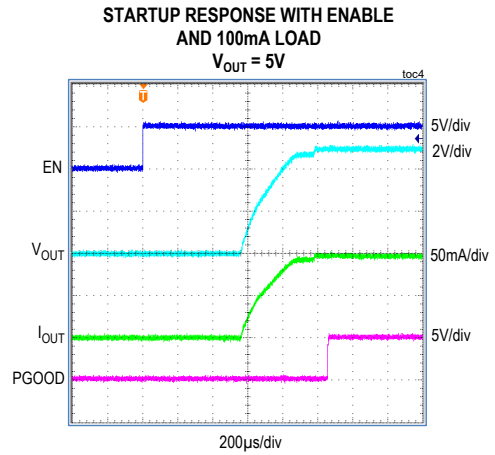
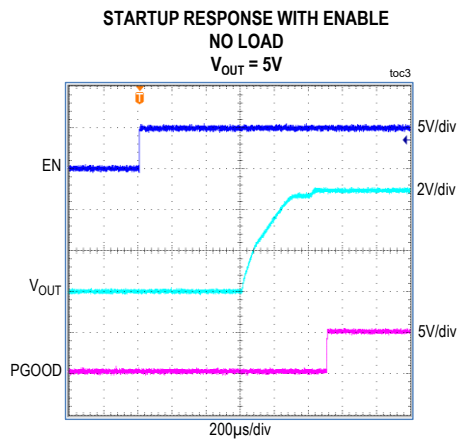
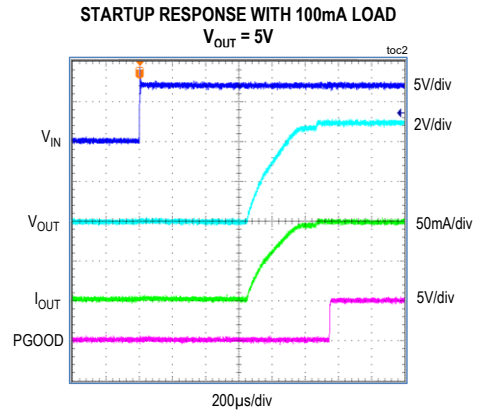
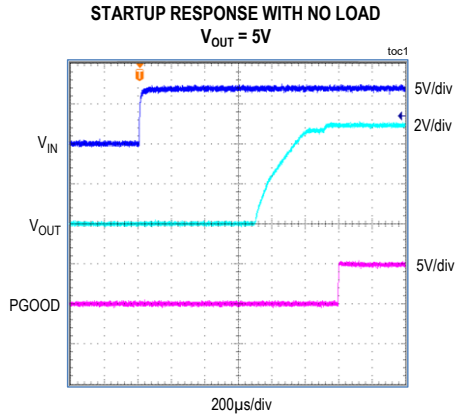

EV Kit Performance (continued)

($V_{IN} = 7V$, $T_A = +25^\circ C$, unless otherwise noted.)

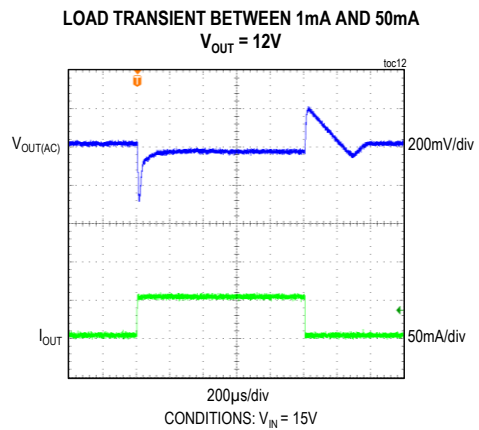
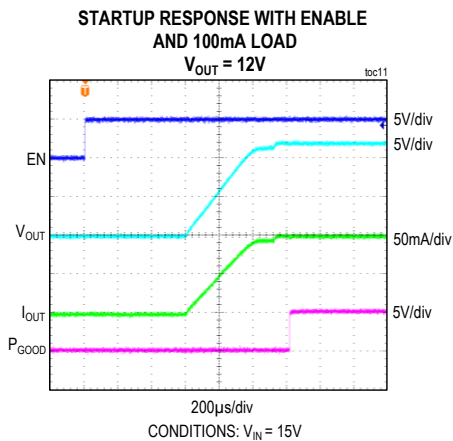
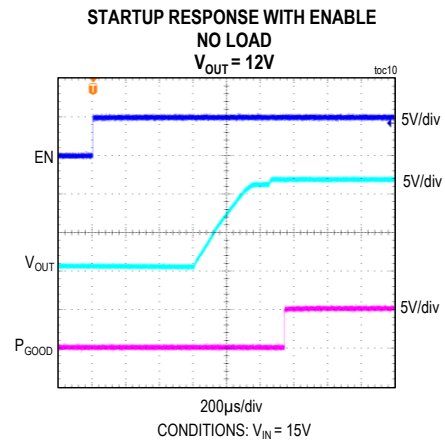
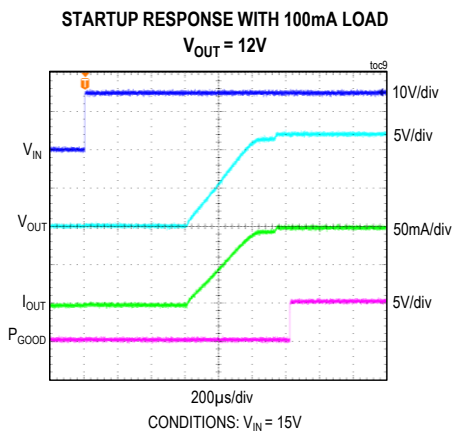
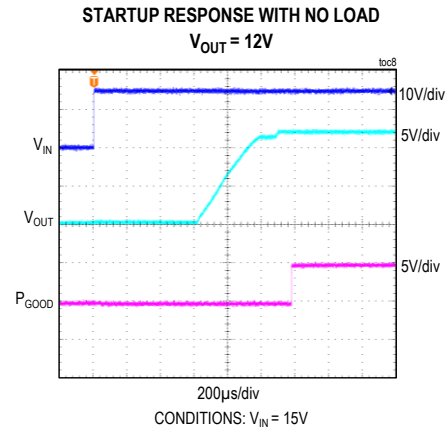
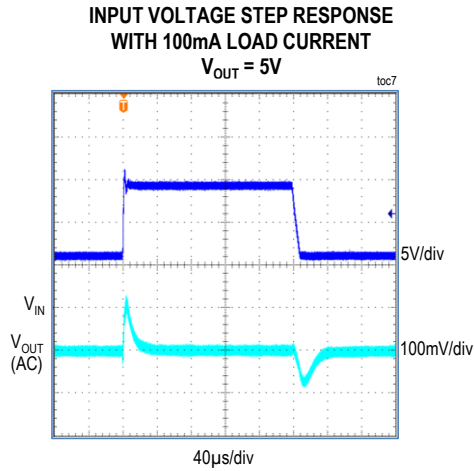

EV Kit Performance (continued)

($V_{IN} = 7V$, $T_A = +25^\circ C$, unless otherwise noted.)

LOAD TRANSIENT BETWEEN 50mA AND 100mA
 $V_{OUT} = 12V$

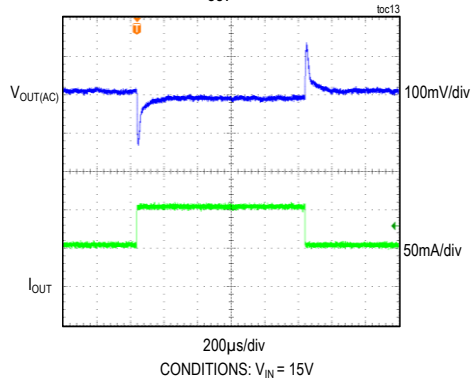

INPUT VOLTAGE STEP RESPONSE
WITH 100mA LOAD CURRENT
 $V_{OUT} = 12V$

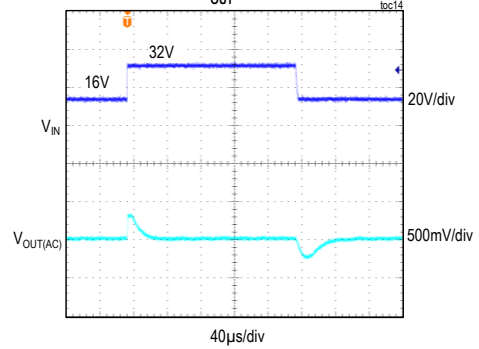

LOAD TRANSIENT BETWEEN 1mA AND 50mA
 $V_{OUT} = 3.3V$

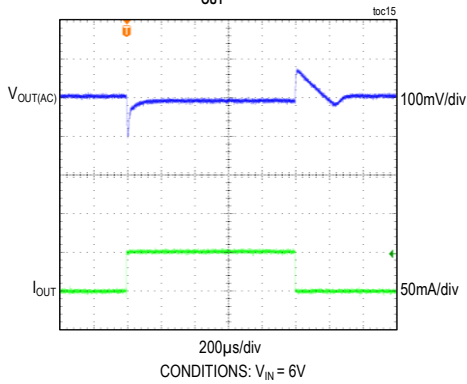

LOAD TRANSIENT BETWEEN 50mA AND 100mA
 $V_{OUT} = 3.3V$

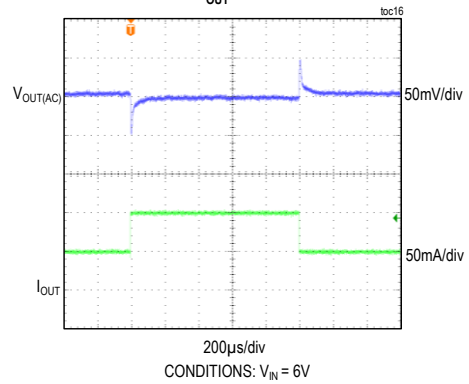

INPUT VOLTAGE STEP RESPONSE
WITH 100mA LOAD CURRENT
 $V_{OUT} = 3.3V$

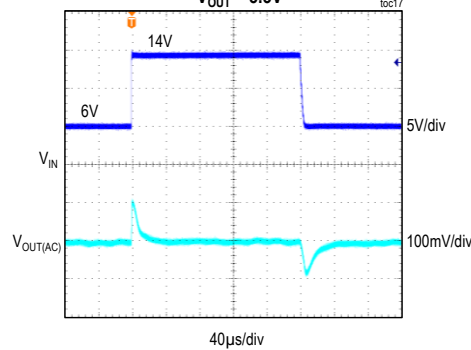

Component Suppliers

SUPPLIER	WEBSITE
Murata Americas	www.murata.com
Panasonic	www.industrial.panasonic.com

Ordering Information

PART	TYPE
ADPL42001EVKIT#	EV Kit

#Denotes RoHS-compliance.

ADPL42001 EV Kit Bill of Materials

ADPL42001AZT+

ITEM	DESIGNATOR	DESCRIPTION	QTY	MANUFACTURER PART NUMBER
1	C101	10 μ F \pm 20%, 80V, Electrolytic Capacitor	1	PANASONIC EEE-FK1K100XP
2	C102	0.1 μ F \pm 10%, 100V, X7R, 0603	1	MURATA GRM188R72A104KA35
3	C103	4.7 μ F \pm 10%, 10V, X7R, 0805	1	MURATA GRM21BR71A475KA73
4	R101	432k Ω \pm 1%, 0402	1	
5	R102	59k Ω \pm 1%, 0402	1	
6	R103	267k Ω \pm 1%, 0402	1	
7	R105	100k Ω \pm 1%, 0402	1	
8	U101	4V to 20V, 100mA, Ultra-Low Quiescent Current, Linear Regulator (6 TSOT)	1	ANALOG DEVICES ADPL42001AZT+

ADPL42001ATT+

ITEM	DESIGNATOR	DESCRIPTION	QTY	MANUFACTURER PART NUMBER
1	C201	10 μ F \pm 20%, 80V, Electrolytic Capacitor	1	PANASONIC EEE-FK1K100XP
2	C202	0.1 μ F \pm 10%, 100V, X7R, 0603	1	MURATA GRM188R72A104KA35
3	C203	4.7 μ F \pm 10%, 16V, X7R, 0805	1	MURATA GRM21BR71C475KA73
4	R201	698k Ω \pm 1%, 0402	1	
5	R202	59k Ω \pm 1%, 0402	1	
6	R203	348k Ω \pm 1%, 0402	1	
7	R204	1.13M Ω \pm 1%, 0402	1	
8	R205	100k Ω \pm 1%, 0402	1	
9	R206	71.5k Ω \pm 1%, 0402	1	
10	R207	1k Ω \pm 1%, 0402	1	
11	U201	4V to 20V, 100mA, Ultra-Low Quiescent Current, Linear Regulator (6 TDFN-EP)	1	ANALOG DEVICES ADPL42001ATT+

ADPL42001 EV Kit Schematic

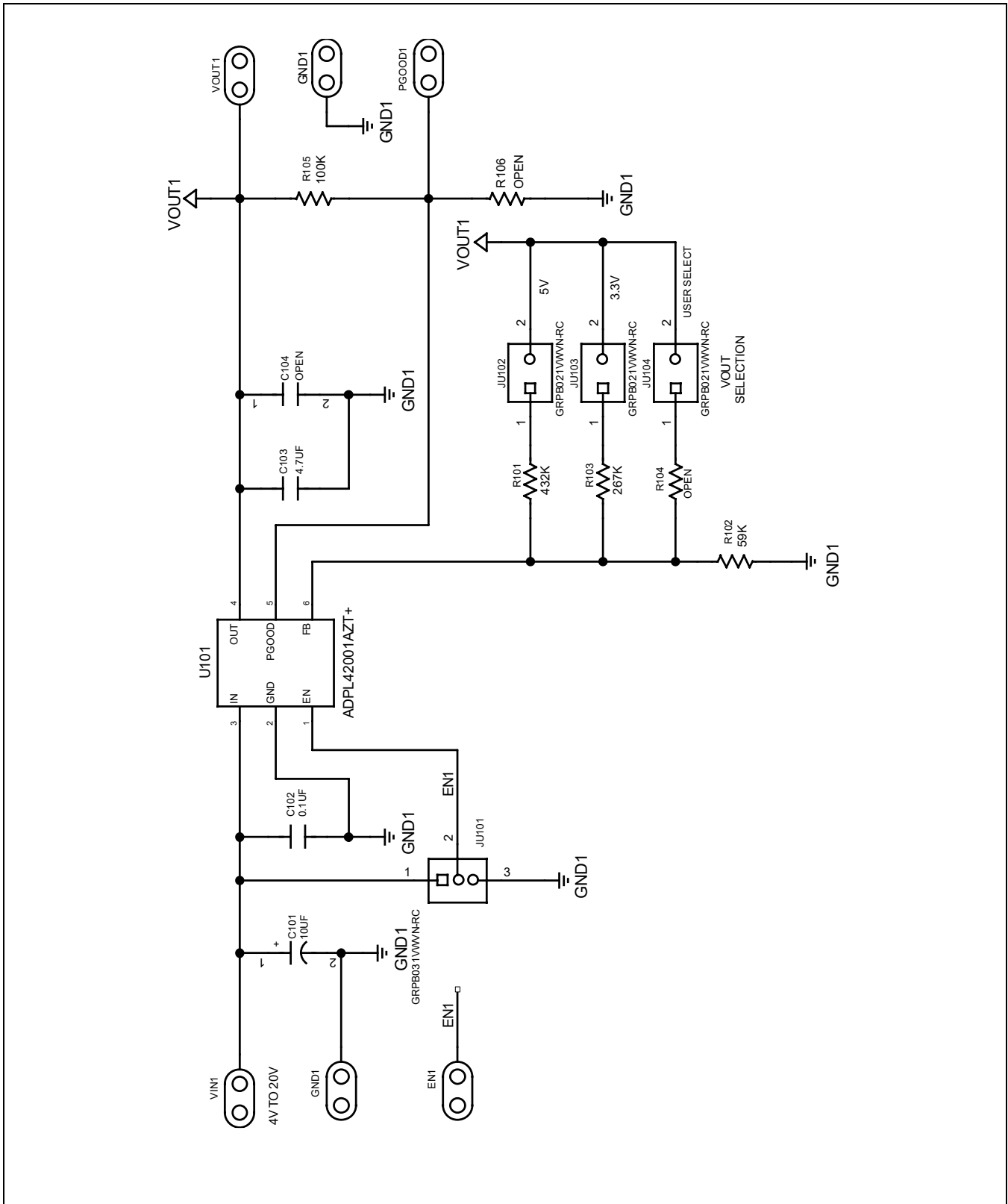

ADPL42001 EV Kit Schematic (continued)

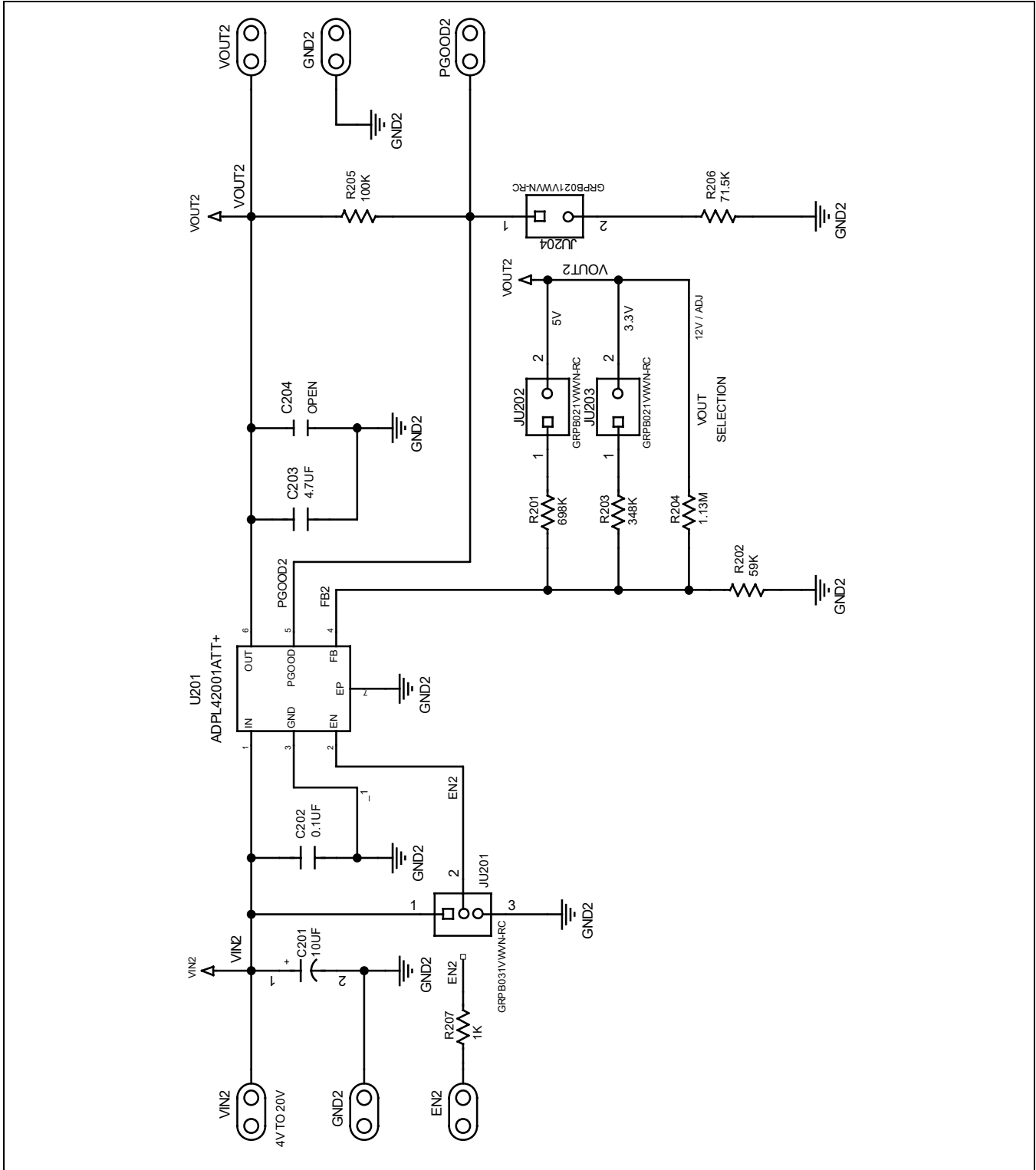

ADPL42001 EV Kit PCB Layout

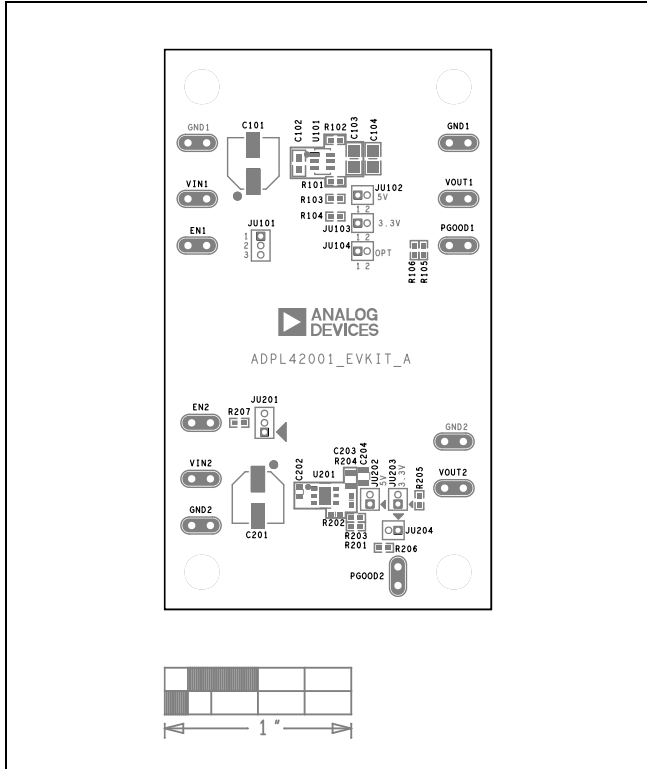

ADPL42001EVKIT—Top Silkscreen

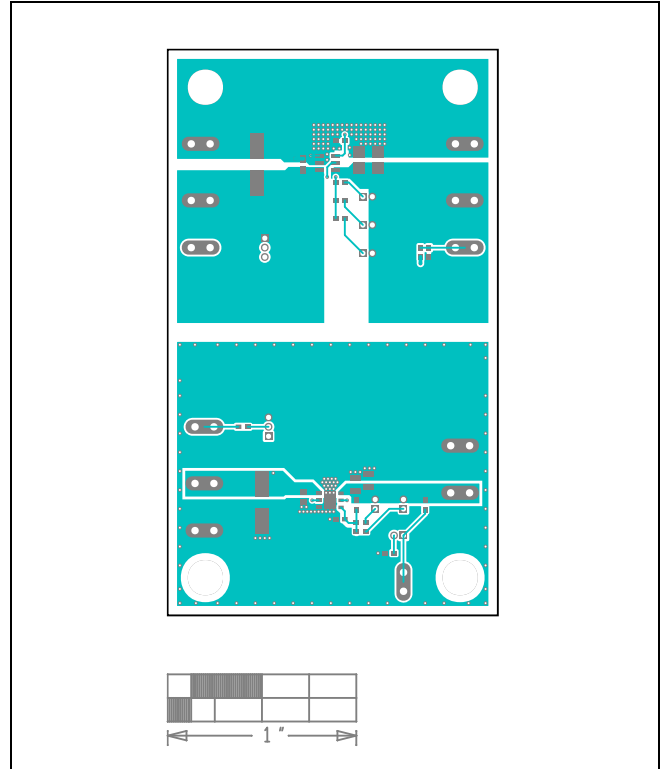

ADPL42001EVKIT—Layer 1

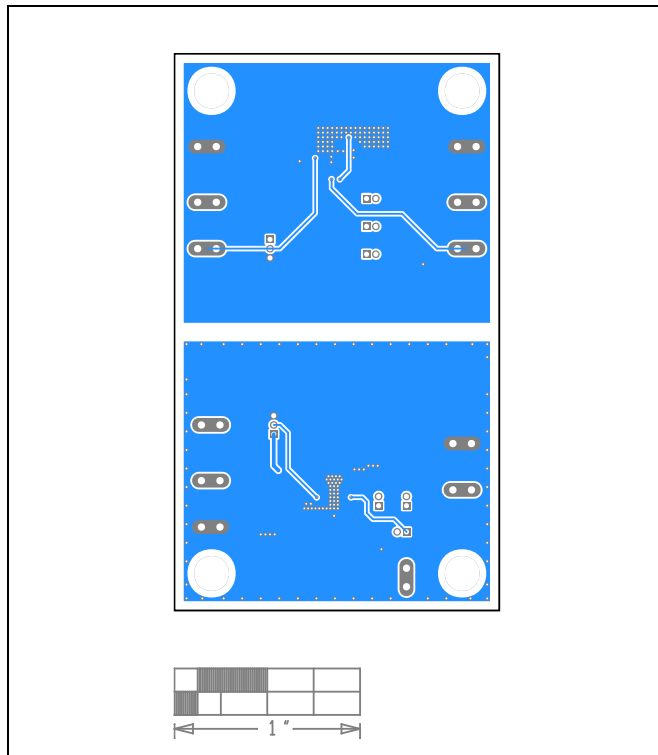

*ADPL42001EVKIT—Layer 2***Revision History**

REVISION NUMBER	REVISION DATE	DESCRIPTION	PAGES CHANGED
0	08/24	Initial release	—

Notes

ALL INFORMATION CONTAINED HEREIN IS PROVIDED “AS IS” WITHOUT REPRESENTATION OR WARRANTY. NO RESPONSIBILITY IS ASSUMED BY ANALOG DEVICES FOR ITS USE, NOR FOR ANY INFRINGEMENTS OF PATENTS OR OTHER RIGHTS OF THIRD PARTIES THAT MAY RESULT FROM ITS USE. SPECIFICATIONS ARE SUBJECT TO CHANGE WITHOUT NOTICE. NO LICENSE, EITHER EXPRESSED OR IMPLIED, IS GRANTED UNDER ANY ADI PATENT RIGHT, COPYRIGHT, MASK WORK RIGHT, OR ANY OTHER ADI INTELLECTUAL PROPERTY RIGHT RELATING TO ANY COMBINATION, MACHINE, OR PROCESS, IN WHICH ADI PRODUCTS OR SERVICES ARE USED. TRADEMARKS AND REGISTERED TRADEMARKS ARE THE PROPERTY OF THEIR RESPECTIVE OWNERS.

Mouser Electronics

Authorized Distributor

Click to View Pricing, Inventory, Delivery & Lifecycle Information:

[Analog Devices Inc.:](#)

[ADPL42001EVKIT#](#)