

## 40V, 200mA, Low Noise, CMOS LDO Linear Regulator

### FEATURES

- ▶ Low Noise:  $20\mu\text{V}_{\text{RMS}}$  Independent of Fixed Output Voltage
- ▶ PSRR of 78dB at 10 kHz,  $V_{\text{OUT}} \leq 5\text{V}$ ,  $V_{\text{IN}} = 7\text{V}$
- ▶ Input Voltage Range: 2.7V to 40V
- ▶ Maximum Output Current: 200mA
- ▶ Initial Accuracy:  $\pm 1\%$
- ▶ Accuracy Over Line, Load, and Temperature
  - ▶  $\pm 1.8\%$ ,  $T_J = -40^\circ\text{C}$  to  $+125^\circ\text{C}$
- ▶ Low Dropout Voltage: 220mV (typical) at a 200mA Load,  $V_{\text{OUT}} = 5\text{V}$
- ▶ User Programmable Soft Start (LFCSP only)
- ▶ Low Quiescent Current,  $I_{\text{GND}} = 80\mu\text{A}$  (typical) with no Load
- ▶ Low Shutdown Current:  $1.8\mu\text{A}$  at  $V_{\text{IN}} = 6\text{V}$ ,  $3.0\mu\text{A}$  at  $V_{\text{IN}} = 40\text{V}$
- ▶ Stable with a Small 2.2  $\mu\text{F}$  Ceramic Output Capacitor
- ▶ Fixed Output Voltage Options: 1.8V, 2.5V, 3.3V, and 5.0V
- ▶ Adjustable Output from 1.2V to  $V_{\text{IN}} - V_{\text{DO}}$ , Output can be Adjusted Above Initial Set Point
- ▶ Precision Enable
- ▶ 2mm  $\times$  2mm, 6-Lead LFCSP, 5-Lead TSOT

### APPLICATIONS

- ▶ Regulation to Noise Sensitive Applications
  - ▶ ADC, DAC Circuits, Precision Amplifiers, Power for VCO  $V_{\text{TUNE}}$  Control
- ▶ Communications and Infrastructure
- ▶ Medical and Healthcare
- ▶ Industrial and Instrumentation

### GENERAL DESCRIPTION

The ADPL44002 is a CMOS, low dropout (LDO) linear regulator that operates from 2.7V to 40V and provides up to 200mA of output current. This high input voltage LDO is ideal for the regulation of high performance analog and mixed signal circuits operating from 39V down to 1.2V rails. Using an advanced proprietary architecture, the device provides high power supply rejection, low noise, and achieves excellent line and load transient response with a small 2.2 $\mu\text{F}$  ceramic output capacitor. The ADPL44002 regulator output noise is  $20\mu\text{V}_{\text{RMS}}$  independent of the output voltage for the fixed options of 5V or less.

The ADPL44002 is available in four fixed output voltage options. The following voltages are available from stock: 1.2V (adjustable), 1.8V, 2.5V, 3.3V, and 5.0V.

Each fixed output voltage can be adjusted above the initial set point with an external feedback divider. This allows the ADPL44002 to provide an output voltage from 1.2V to  $V_{\text{IN}} - V_{\text{DO}}$  with high PSRR and low noise.

User programmable soft start with an external capacitor is available in the LFCSP package.

The ADPL44002 is available in a 6-lead, 2mm  $\times$  2mm LFCSP, making it not only a very compact solution, but it also provides excellent thermal performance for applications requiring up to 200mA of output current in a small, low profile footprint. The ADPL44002 is also available in a 5-lead TSOT.

TYPICAL APPLICATION CIRCUITS

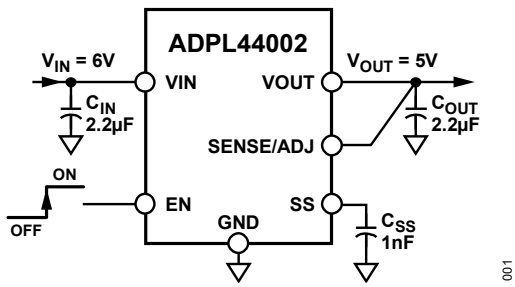

Figure 1. ADPL44002 with Fixed Output Voltage, 5V

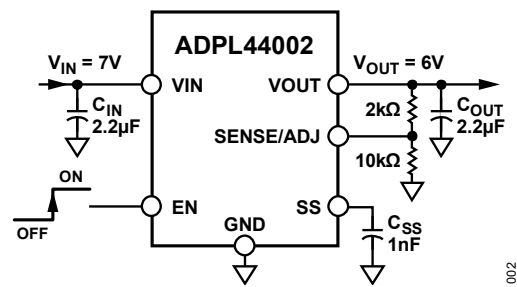

Figure 2. ADPL44002 with 5V Output Adjusted to 6V

## TABLE OF CONTENTS

Features.....	1
Applications .....	1
General Description .....	1
Typical Application Circuits .....	2
Specifications.....	4
Absolute Maximum Ratings .....	6
Thermal Data .....	6
Thermal Resistance.....	7
ESD Caution .....	7
Pin Configurations and Function Descriptions.....	8
Pin Descriptions .....	8
Typical Performance Characteristics .....	9
Theory of Operation .....	13
Applications Information .....	14
Design Tools .....	14
Capacitor Selection.....	14
Output Capacitor .....	14
Input Bypass Capacitor .....	14
Programmable Precision Enable .....	14
Soft Start.....	16
Noise Reduction of the ADPL44002 in Adjustable Mode.....	17
Effect of Noise Reduction on Start-Up Time.....	17
Current-Limit and Thermal Overload .....	18
Printed Circuit Board Layout Considerations.....	18
Outline Dimensions .....	20
Ordering Guide.....	21
Revision history .....	22

## SPECIFICATIONS

**Table 1. Electrical Characteristics**

( $V_{IN} = V_{OUT} + 1V$  or  $2.7V$ , whichever is greater,  $V_{OUT} = 5V$ ,  $V_{EN} = V_{IN}$ ,  $I_{OUT} = 10mA$ ,  $C_{IN} = C_{OUT} = 2.2\mu F$ ,  $C_{SS} = OPEN$ ,  $T_A = 25^\circ C$  for typical specifications,  $T_J = -40^\circ C$  to  $+125^\circ C$  for minimum/maximum specifications, unless otherwise noted.)

PARAMETER	SYMBOL	CONDITIONS	MIN	TYP	MAX	UNITS
Input Voltage Range	$V_{IN}$		2.7		40	V
Operating Supply Current	$I_{GND}$	$I_{OUT} = 0\mu A$		80	170	$\mu A$
Operating Supply Current	$I_{GND}$	$I_{OUT} = 200mA$		240	380	$\mu A$
Shutdown Current	$I_{GND-SD}$	EN = GND		1.8		$\mu A$
		EN = GND, $V_{IN} = 40V$		3.0	10	$\mu A$

### OUTPUT VOLTAGE ACCURACY

Output Voltage Accuracy	$V_{OUT}$	$I_{OUT} = 10mA$ , $T_J = 25^\circ C$	-1		+1	%
Output Voltage Accuracy	$V_{OUT}$	$100\mu A < I_{OUT} < 200mA$ , $V_{IN} = (V_{OUT} + 1V)$ to $40V$	-1.8		+1.8	%
Line Regulation	$\Delta V_{OUT}/\Delta V_{IN}$	$V_{IN} = (V_{OUT} + 1V)$ to $40V$	-0.01		+0.01	%/V
Load Regulation <sup>1</sup>	$\Delta V_{OUT}/\Delta I_{OUT}$	$I_{OUT} = 100\mu A$ to $200mA$		0.002	0.004	%/mA
Sense Input Bias Current	$SENSE_{I-BIAS}$	$100\mu A < I_{OUT} < 200mA$ , $V_{IN} = (V_{OUT} + 1V)$ to $40V$		10	1000	nA
Dropout Voltage <sup>2</sup>	$V_{DROPOUT}$	$I_{OUT} = 10mA$		30	60	mV
Dropout Voltage <sup>2</sup>	$V_{DROPOUT}$	$I_{OUT} = 200mA$		220	450	mV
Start-Up Time <sup>3</sup>	$t_{START-UP}$			400		$\mu s$
Soft Start Source Current	$SS_{I-SOURCE}$	SS = GND		1.15		$\mu A$
Current-Limit Threshold <sup>4</sup>	$I_{LIMIT}$		250	360	460	mA

### THERMAL SHUTDOWN

Threshold	$TS_{SD}$	$T_J$ rising		150		$^\circ C$
Hysteresis	$TS_{SD-HYS}$	$T_J$ rising		15		$^\circ C$

### UNDERVOLTAGE THRESHOLDS

Input Voltage Rising	$UVLO_{RISE}$				2.7	V
Input Voltage Falling	$UVLO_{FALL}$		2.2			V
Hysteresis	$UVLO_{HYS}$			230		mV

( $V_{IN} = V_{OUT} + 1V$  or  $2.7V$ , whichever is greater,  $V_{OUT} = 5V$ ,  $V_{EN} = V_{IN}$ ,  $I_{OUT} = 10mA$ ,  $C_{IN} = C_{OUT} = 2.2\mu F$ ,  $C_{SS} = OPEN$ ,  $T_A = 25^\circ C$  for typical specifications,  $T_J = -40^\circ C$  to  $+125^\circ C$  for minimum/maximum specifications, unless otherwise noted.)

PARAMETER	SYMBOL	CONDITIONS	MIN	TYP	MAX	UNITS
<b>PRECISION EN INPUT</b>						
Logic High	$EN_{HIGH}$	$2.7V \leq V_{IN} \leq 40V$	1.15	1.22	1.30	V
Logic Low	$EN_{LOW}$	$2.7V \leq V_{IN} \leq 40V$	1.06	1.12	1.18	V
Logic Hysteresis	$EN_{HYS}$	$2.7V \leq V_{IN} \leq 40V$		100		mV
Leakage Current	$I_{EN-LKG}$	$EN = V_{IN}$ or GND, $2.7V \leq V_{IN} \leq 40V$		0.04	1	$\mu A$
Delay Time	$t_{EN-DLY}$	From EN rising from 0V to $V_{IN}$ to $0.1 \times V_{OUT}$ , $2.7V \leq V_{IN} \leq 40V$		80		$\mu s$
Output Noise	$OUT_{NOISE}$	10Hz to 100kHz, all output voltage options		20		$\mu V_{RMS}$
Power Supply Rejection Ratio	PSRR	1MHz, $V_{IN} = 7V$ , $V_{OUT} = 5V$		40		dB
		100kHz, $V_{IN} = 7V$ , $V_{OUT} = 5V$		58		dB
		10kHz, $V_{IN} = 7V$ , $V_{OUT} = 5V$		78		dB

- Based on an endpoint calculation using 100 $\mu A$  and 200mA loads. See [Figure 6](#) for typical load regulation performance for loads less than 1mA.
- Dropout voltage is defined as the input-to-output voltage differential when the input voltage is set to the nominal output voltage. Dropout applies only for output voltages above 2.7V.
- Start-up time is defined as the time between the rising edge of EN to OUT being at 90% of its nominal value.
- Current-limit threshold is defined as the current at which the output voltage drops to 90% of the specified typical value. For example, the current limit for a 5.0V output voltage is defined as the current that causes the output voltage to drop to 90% of 5.0V or 4.5V.

**Table 2. Input and Output Capacitance, Recommended Specifications**

PARAMETER	SYMBOL	CONDITIONS	MIN	TYP	MAX	UNITS
<b>INPUT AND OUTPUT CAPACITANCE</b>						
Minimum Capacitance <sup>1</sup>	$C_{MIN}$	$T_A = -40^\circ C$ to $+125^\circ C$	1.5			$\mu F$
Capacitor Effective Series Resistance (ESR)	$R_{ESR}$	$T_A = -40^\circ C$ to $+125^\circ C$	0.001		0.3	$\Omega$

- The minimum input and output capacitance must be greater than 1.5 $\mu F$  over the full range of operating conditions. The full range of operating conditions in the application must be considered during device selection to ensure that the minimum capacitance specification is met. X7R and X5R type capacitors are recommended, while Y5V and Z5U capacitors are not recommended for use with any LDO.

## ABSOLUTE MAXIMUM RATINGS

**Table 3. Absolute Maximum Ratings**

PARAMETER	RATING
V <sub>IN</sub> to GND	-0.3V to +44V
V <sub>OUT</sub> to GND	-0.3 to V <sub>IN</sub>
EN to GND	-0.3V to +44V
SENSE/ADJ to GND	-0.3V to +6V
SS to GND	-0.3V to V <sub>IN</sub> or +6V (whichever is less)
Storage Temperature Range	-65°C to +150°C
Junction Temperature (T <sub>J</sub> )	150°C
Operating Ambient Temperature (T <sub>A</sub> ) Range	-40°C to +125°C
Soldering Conditions	JEDEC J-STD-020
<b>ESD</b>	
6-Lead LFCSP Human Body Model (HBM)	±1000V
6-Lead LFCSP Field Induced Charged Device Model (FICDM)	±1000V
5-Lead TSOT HBM	±1000V
5-Lead TSOT FICDM	±1250V

Stresses beyond those listed under Absolute Maximum Ratings may cause permanent damage to the device. These are stress ratings only, functional operation of the product at these or any other conditions above those indicated in the operational section of this specification is not implied. Operation beyond the maximum operating conditions for extended periods may affect product reliability.

### Thermal Data

Absolute maximum ratings apply individually only, not in combination. The ADPL44002 can be damaged when the junction temperature limits are exceeded. Monitoring ambient temperature does not guarantee that T<sub>J</sub> is within the specified temperature limits. In applications with high power dissipation and poor thermal resistance, the maximum ambient temperature may have to be derated.

In applications with moderate power dissipation and low printed circuit board (PCB) thermal resistance, the maximum ambient temperature can exceed the maximum limit as long as the junction temperature is within specification limits. The junction temperature of the device is dependent on the ambient temperature, the power dissipation (P<sub>D</sub>) of the device, and the junction-to-ambient thermal resistance of the package (θ<sub>JA</sub>).

Maximum T<sub>J</sub> is calculated from the T<sub>A</sub> and P<sub>D</sub> using the formula.

$$T_J = T_A + P_D \times \theta_{JA} \quad (1)$$

$\theta_{JA}$  of the package is based on modeling and calculation using a 4-layer board. The  $\theta_{JA}$  is highly dependent on the application and board layout. In applications where high maximum power dissipation exists, close attention to thermal board design is required. The value of  $\theta_{JA}$  may vary depending on PCB material, layout, and environmental conditions. The specified values of  $\theta_{JA}$  are based on a 4-layer, 4 inches  $\times$  3 inches circuit board. See JESD51-7 and JESD51-9 for detailed information on the board construction.

$\Psi_{JB}$  is the junction-to-board thermal characterization parameter with units of  $^{\circ}\text{C}/\text{W}$ . The  $\Psi_{JB}$  of the package is based on modeling and calculation using a 4-layer board. The JESD51-12, Guidelines for Reporting and Using Electronic Package Thermal Information, states that thermal characterization parameters are not the same as thermal resistances.  $\Psi_{JB}$  measures the component power flowing through multiple thermal paths rather than a single path, as in thermal resistance ( $\theta_{JB}$ ). Therefore,  $\Psi_{JB}$  thermal paths include convection from the top of the package as well as radiation from the package, factors that make  $\Psi_{JB}$  more useful in real-world applications. Maximum  $T_J$  is calculated from the board temperature ( $T_B$ ) and  $P_D$  using the formula.

$$T_J = T_B + P_D \times \Psi_{JB} \quad (2)$$

See JESD51-8 and JESD51-12 for more detailed information about  $\Psi_{JB}$ .

## Thermal Resistance

$\theta_{JA}$ ,  $\theta_{JC}$ , and  $\Psi_{JB}$  are specified for the worst-case conditions, that is, a device soldered in a circuit board for surface-mount packages.

**Table 4. Thermal Resistance**

PACKAGE TYPE	$\theta_{JA}$	$\theta_{JC}$	$\Psi_{JB}$	UNIT
6-Lead LFCSP	72.1	42.3	47.1	$^{\circ}\text{C}/\text{W}$
5-Lead TSOT	170	N/A <sup>1</sup>	43	$^{\circ}\text{C}/\text{W}$

<sup>1</sup> N/A means not applicable.

## ESD Caution



**ESD (electrostatic discharge) sensitive device.** Charged devices and circuit boards can discharge without detection. Although this product features patented or proprietary protection circuitry, damage may occur on devices subjected to high energy ESD. Therefore, proper ESD precautions should be taken to avoid performance degradation or loss of functionality.

## PIN CONFIGURATIONS AND FUNCTION DESCRIPTIONS

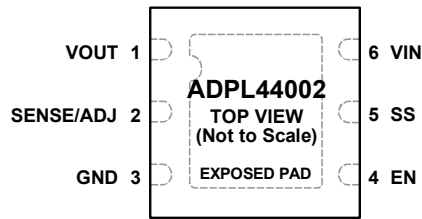

## NOTES

1. THE EXPOSED PAD ON THE BOTTOM OF THE PACKAGE ENHANCES THERMAL PERFORMANCE AND IS ELECTRICALLY CONNECTED TO GND INSIDE THE PACKAGE. IT IS RECOMMENDED THAT THE EXPOSED PAD CONNECT TO THE GROUND PLANE ON THE BOARD.

Figure 3. 6-Lead LFCSP Pin Configuration

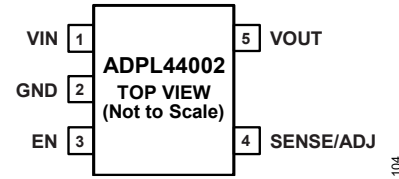

Figure 4. 5-Lead TSOT Pin Configuration

## Pin Descriptions

Table 5. Pin Descriptions

PIN		NAME	DESCRIPTION
6-LEAD LFCSP	5-LEAD TSOT		
1	5	$V_{OUT}$	Regulated Output Voltage. Bypass $V_{OUT}$ to GND with a 2.2 $\mu$ F or greater capacitor.
2	4	SENSE/ADJ	Sense Input (SENSE). Connect to load. An external resistor divider may also be used to set the output voltage higher than the fixed output voltage (ADJ).
3	2	GND	Ground.
4	3	EN	The Enable Pin Controls the operation of the LDO. Drive EN high to turn on the regulator. Drive EN low to turn off the regulator. For automatic startup, connect EN to $V_{IN}$ .
5	Not applicable	SS	Soft Start. An external capacitor connected to this pin determines the soft-start time. Leave this pin open for a typical 400 $\mu$ s start-up time. Do not ground this pin.
6	1	$V_{IN}$	Regulator Input Supply. Bypass $V_{IN}$ to GND with a 2.2 $\mu$ F or greater capacitor.
		EP	Exposed Pad. The exposed pad on the bottom of the package enhances thermal performance and is electrically connected to GND inside the package. It is recommended that the exposed pad connect to the ground plane on the board.



### TYPICAL PERFORMANCE CHARACTERISTICS

$V_{IN} = V_{OUT} + 1V$  or  $2.7V$ , whichever is greater,  $V_{OUT} = 5V$ ,  $I_{OUT} = 10mA$ ,  $C_{IN} = C_{OUT} = 2.2\mu F$ ,  $T_A = 25^\circ C$ , unless otherwise noted.

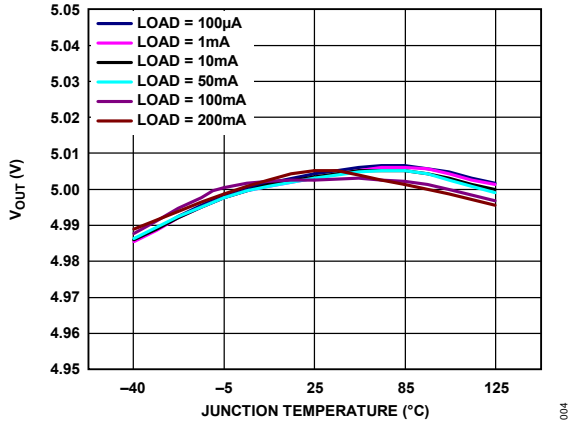

Figure 5. Output Voltage ( $V_{OUT}$ ) vs. Junction Temperature ( $T_J$ )

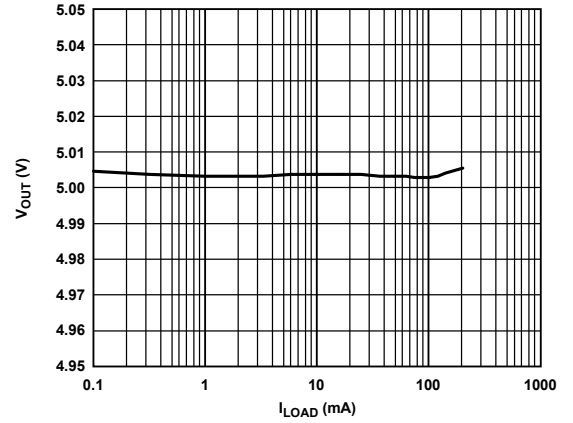

Figure 6. Output Voltage ( $V_{OUT}$ ) vs. Load Current ( $I_{LOAD}$ )

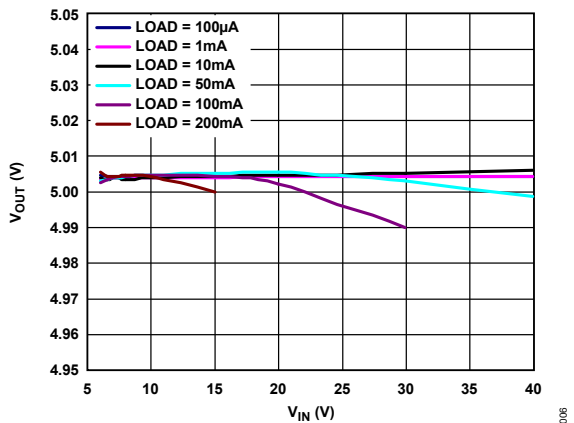

Figure 7. Output Voltage ( $V_{OUT}$ ) vs. Input Voltage ( $V_{IN}$ )

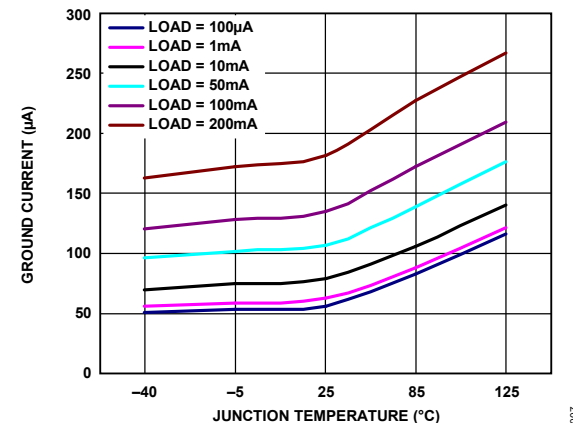

Figure 8. Ground Current ( $I_{GND}$ ) vs. Junction Temperature ( $T_J$ )

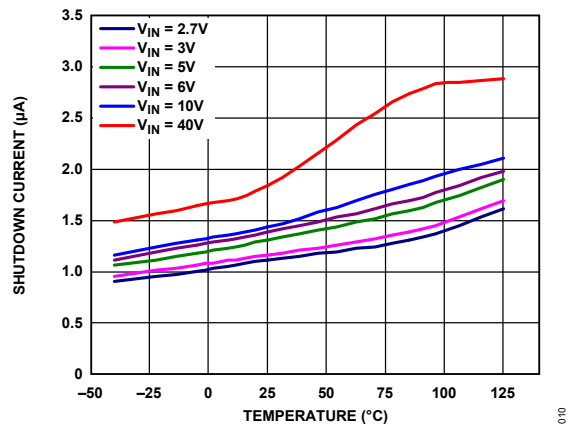

Figure 9. Shutdown Current ( $I_{GND-SD}$ ) vs. Temperature at Various Input Voltages ( $V_{IN}$ )

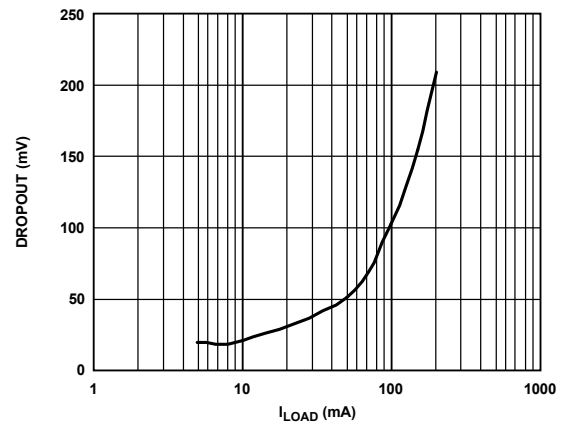

Figure 10. Dropout Voltage ( $V_{DROPOUT}$ ) vs. Load Current ( $I_{LOAD}$ ),  $V_{OUT} = 5V$

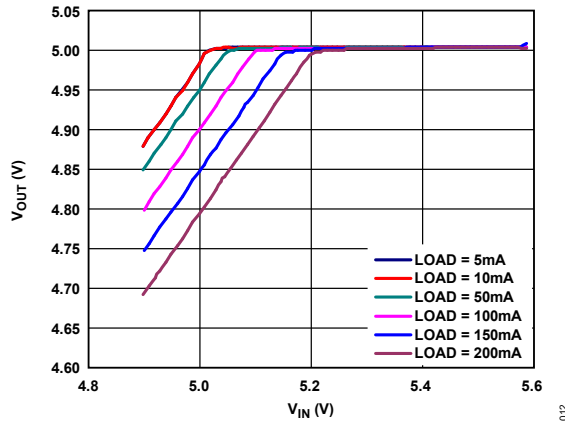

Figure 11. Output Voltage ( $V_{OUT}$ ) vs. Input Voltage ( $V_{IN}$ ) in Dropout,  $V_{OUT} = 5V$

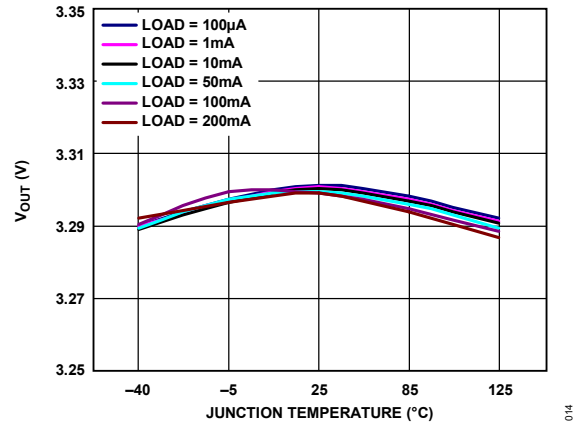

Figure 12. Output Voltage ( $V_{OUT}$ ) vs. Junction Temperature ( $T_J$ ),  $V_{OUT} = 3.3V$

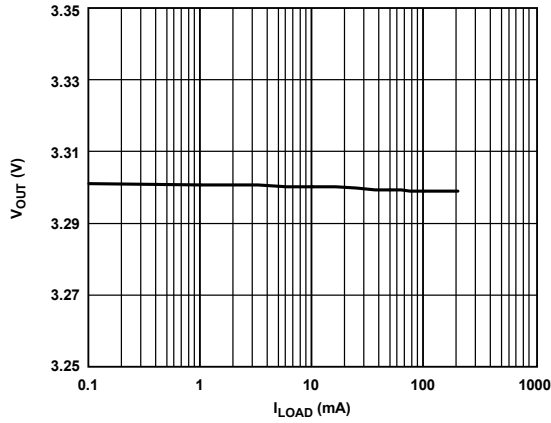

Figure 13. Output Voltage ( $V_{OUT}$ ) vs. Load Current ( $I_{LOAD}$ ),  $V_{OUT} = 3.3V$

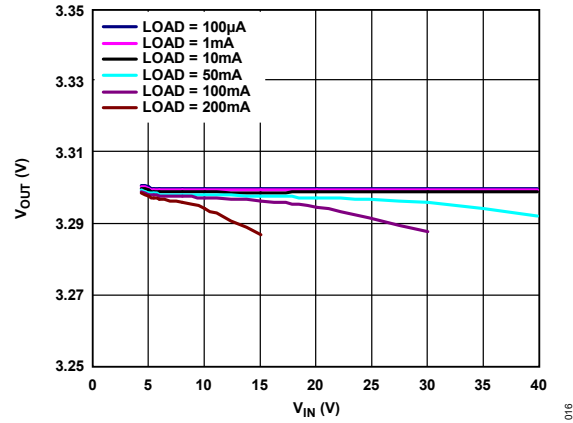

Figure 14. Output Voltage ( $V_{OUT}$ ) vs. Input Voltage ( $V_{IN}$ ),  $V_{OUT} = 3.3V$

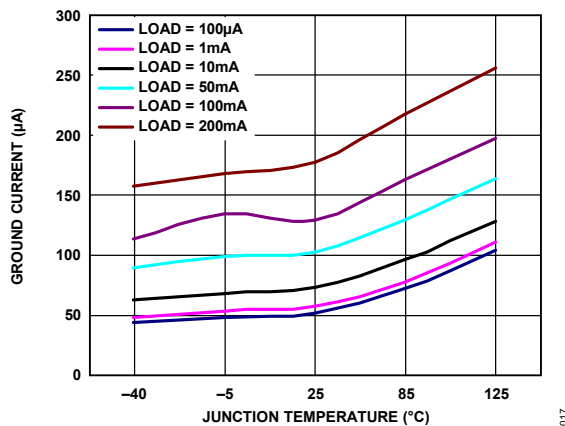

Figure 15. Ground Current ( $I_{GND}$ ) vs. Junction Temperature ( $T_J$ ),  $V_{OUT} = 3.3V$

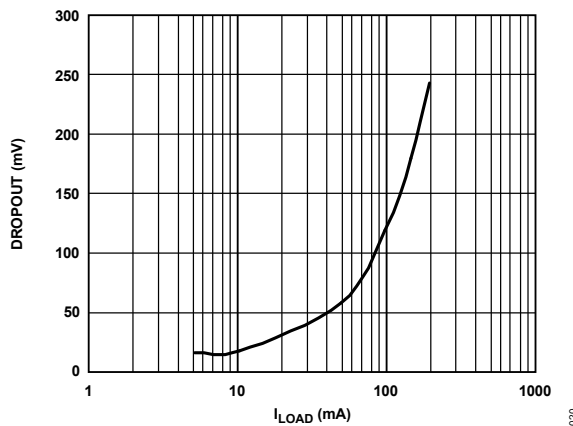

Figure 16. Dropout Voltage ( $V_{DROPOUT}$ ) vs. Load Current ( $I_{LOAD}$ ),  $V_{OUT} = 3.3V$

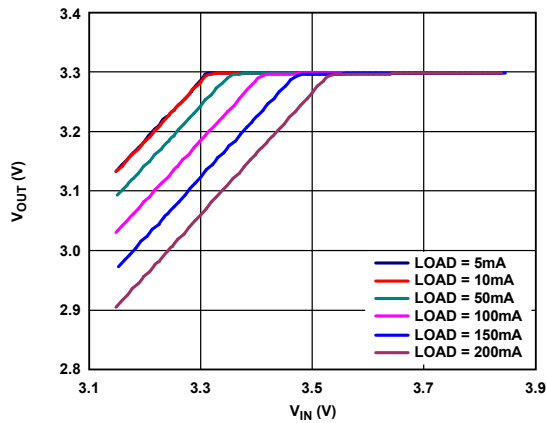

Figure 17. Output Voltage ( $V_{OUT}$ ) vs. Input Voltage ( $V_{IN}$ ) in Dropout,  $V_{OUT} = 3.3V$

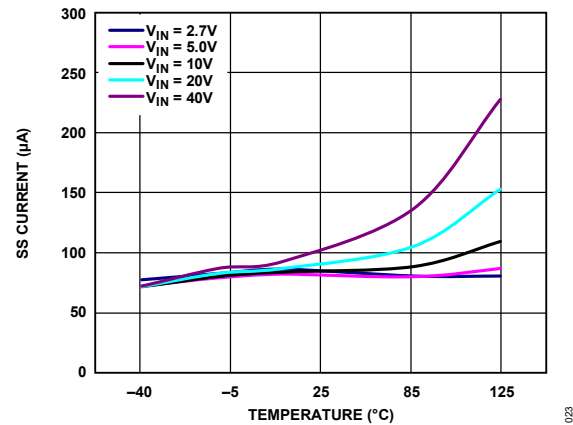

Figure 18. Soft Start (SS) Current vs. Temperature ( $T_J$ ), Multiple Input Voltages ( $V_{IN}$ ),  $V_{OUT} = 5V$

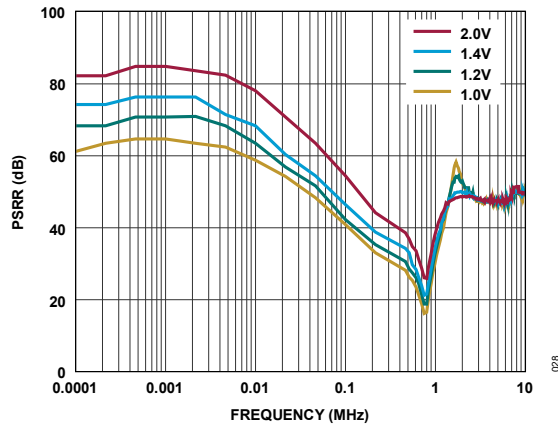

Figure 19. Power Supply Rejection Ratio (PSRR) vs. Frequency,  $V_{OUT} = 5V$ , for Various Headroom Voltages

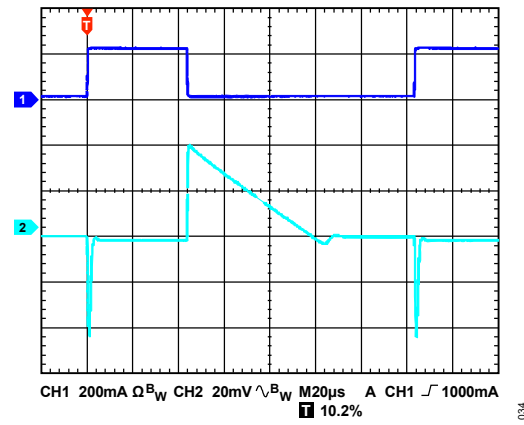

Figure 20. Load Transient Response,  $I_{LOAD} = 1mA$  to  $200mA$ ,  $V_{OUT} = 5V$ ,  $V_{IN} = 7V$ , CH1 Load Current ( $I_{LOAD}$ ), CH2  $V_{OUT}$

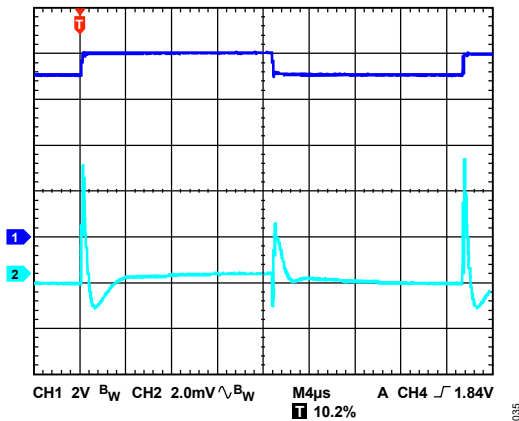

Figure 21. Line Transient Response,  $I_{LOAD} = 200mA$ ,  $V_{OUT} = 5V$ , CH1  $V_{IN}$ , CH2  $V_{OUT}$

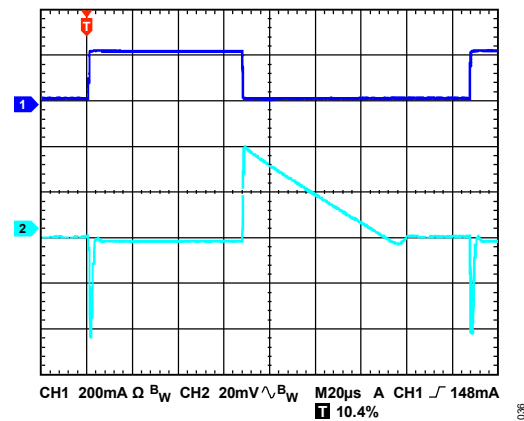

Figure 22. Load Transient Response,  $I_{LOAD} = 1mA$  to  $200mA$ ,  $V_{OUT} = 3.3V$ ,  $V_{IN} = 5V$ , CH1 Load Current ( $I_{LOAD}$ ), CH2  $V_{OUT}$

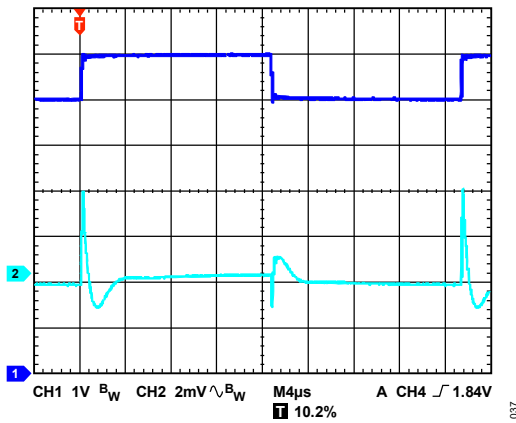

Figure 23. Line Transient Response,  $I_{LOAD} = 200mA$ ,  $V_{OUT} = 3.3V$ , CH1  $V_{IN}$ , CH2  $V_{OUT}$

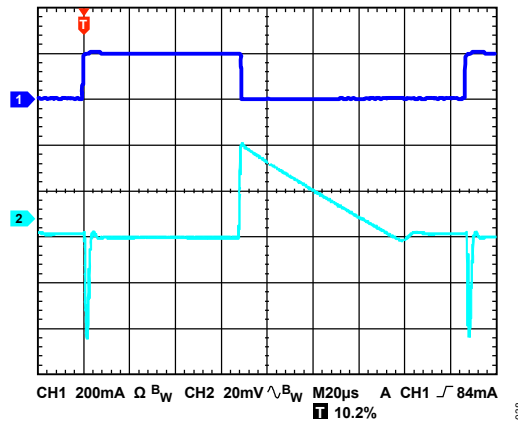

Figure 24. Load Transient Response,  $I_{LOAD} = 1mA$  to  $200mA$ ,  $V_{OUT} = 1.8V$ ,  $V_{IN} = 3V$ , CH1 Load Current ( $I_{LOAD}$ ), CH2  $V_{OUT}$

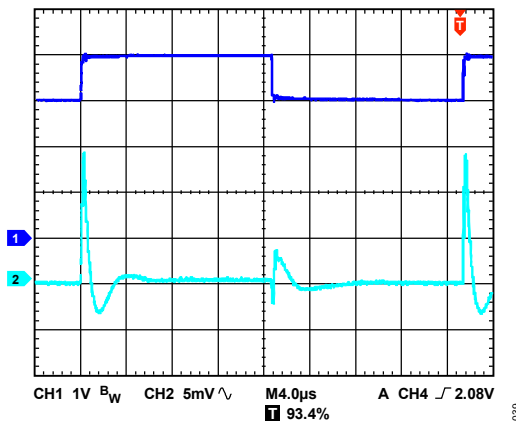

Figure 25. Line Transient Response,  $I_{LOAD} = 200mA$ ,  $V_{OUT} = 1.8V$ , CH1  $V_{IN}$ , CH2  $V_{OUT}$

## THEORY OF OPERATION

The ADPL44002 is a low quiescent current, LDO linear regulator that operates from 2.7V to 40V and provides up to 200mA of output current. Drawing a low 240µA of quiescent current (typical) at full load makes the ADPL44002 ideal for portable equipment. Typical shutdown current consumption is less than 3µA at room temperature.

Optimized for use with small 2.2µF ceramic capacitors, the ADPL44002 provides excellent transient performance.

Internally, the ADPL44002 consists of a reference, an error amplifier, and a PMOS pass transistor. Output current is delivered via the PMOS pass device, which is controlled by the error amplifier. The error amplifier compares the reference voltage with the feedback voltage from the output and amplifies the difference. If the feedback voltage is lower than the reference voltage, the gate of the PMOS device is pulled lower, allowing more current to pass and increasing the output voltage. If the feedback voltage is higher than the reference voltage, the gate of the PMOS device is pulled higher, allowing less current to pass and decreasing the output voltage.

The ADPL44002 is available in four fixed output voltage options, ranging from 1.8V to 5.0V. The ADPL44002 architecture allows any fixed output voltage to be set to a higher voltage with an external voltage divider. For example, a fixed 5V output can be set to a 6V output according to the following equation:

$$V_{OUT} = 5V \left( 1 + \frac{R1}{R2} \right) \quad (3)$$

where R1 and R2 are the resistors in the output voltage divider shown in [Figure 26](#).

To set the output voltage of the adjustable ADPL44002, replace 5V in Equation 3 with 1.2V.

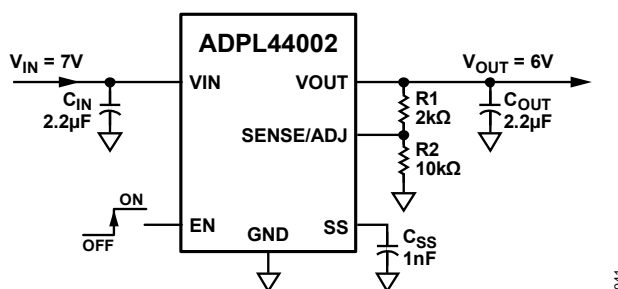

**Figure 26. Typical Adjustable Output Voltage Application Schematic**

It is recommended that the R2 value be less than 200kΩ to minimize errors in the output voltage caused by the SENSE/ADJ pin input current. For example, when R1 and R2 each equal 200kΩ and the default output voltage is 1.2V, the adjusted output voltage is 2.4V. The output voltage error introduced by the SENSE/ADJ pin input current is 1mV or 0.04%, assuming a typical SENSE/ADJ pin input current of 10nA at 25°C.

The ADPL44002 uses the EN pin to enable and disable the V<sub>OUT</sub> pin under normal operating conditions. When EN is high, V<sub>OUT</sub> turns on, and when EN is low, V<sub>OUT</sub> turns off. For automatic startup, EN can be tied to V<sub>IN</sub>.

## APPLICATIONS INFORMATION

### Design Tools

The ADPL44002 is supported by the LTpowerCAD® and LTspice® design tools to produce complete power designs and simulations. For more information on design tools, visit the ADPL44002 product page, [www.analog.com/adpl44002](http://www.analog.com/adpl44002).

### Capacitor Selection

#### Output Capacitor

The ADPL44002 is designed for operation with small, space-saving ceramic capacitors, but functions with general-purpose capacitors as long as care is taken with regard to the effective series resistance (ESR) value. The ESR of the output capacitor affects the stability of the LDO control loop. A minimum of 2.2μF capacitance with an ESR of 0.3Ω or less is recommended to ensure the stability of the ADPL44002. The transient response to changes in load current is also affected by output capacitance. Using a larger value of output capacitance improves the transient response of the ADPL44002 to large changes in load current. *Figure 27* shows the transient responses for an output capacitance value of 2.2μF.

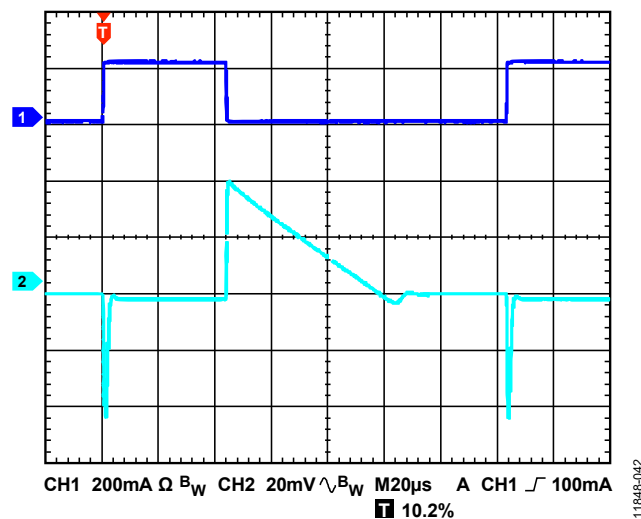

**Figure 27. Output Transient Response,  $V_{OUT} = 5V$ ,  $C_{OUT} = 2.2\mu F$ , CH1 Load Current, CH2  $V_{OUT}$**

#### Input Bypass Capacitor

Connecting a 2.2μF capacitor from  $V_{IN}$  to GND reduces the circuit sensitivity to the PCB layout, especially when long input traces or high source impedance are encountered. If greater than 2.2μF of output capacitance is required, increase the input capacitor to match it.

#### Programmable Precision Enable

The ADPL44002 uses the EN pin to enable and disable the  $V_{OUT}$  pin under normal operating conditions. As shown in *Figure 28*, when a rising voltage on EN crosses the upper threshold, nominally 1.2V,  $V_{OUT}$  turns on. When a falling voltage on EN crosses the lower threshold, nominally 1.1V,  $V_{OUT}$  turns off. The hysteresis of the EN threshold is approximately 100mV.

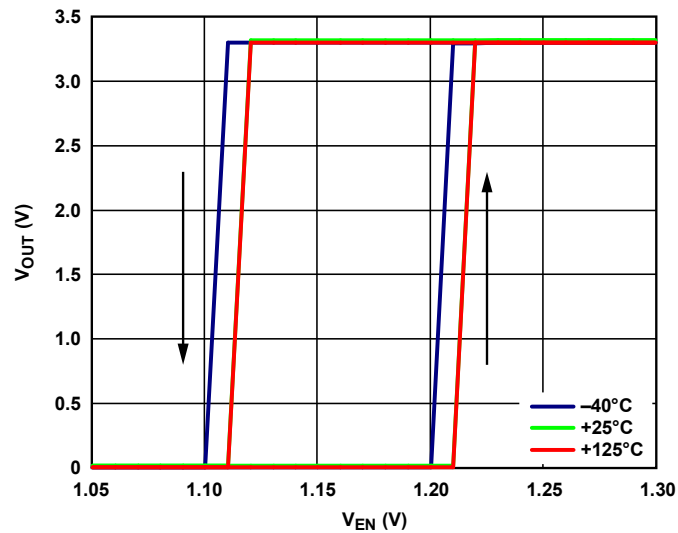

Figure 28. Typical  $V_{OUT}$  Response to EN Pin Operation

The upper and lower thresholds are user programmable and can be set higher than the nominal 1.2V threshold by using two resistors. The resistance values,  $R_{EN1}$  and  $R_{EN2}$ , can be determined by the following equation:

$$R_{EN2} = \text{nominally } 10\text{k}\Omega \text{ to } 100\text{k}\Omega \quad (4)$$

$$R_{EN1} = R_{EN2} \times (V_{IN} - 1.2\text{V}) / 1.2\text{V} \quad (5)$$

where  $V_{IN}$  is the desired turn-on voltage.

The hysteresis voltage increases by the factor  $(R_{EN1} + R_{EN2})/R_{EN2}$ . For the example shown in Figure 29, the enable threshold is 3.6V with a hysteresis of 300mV.

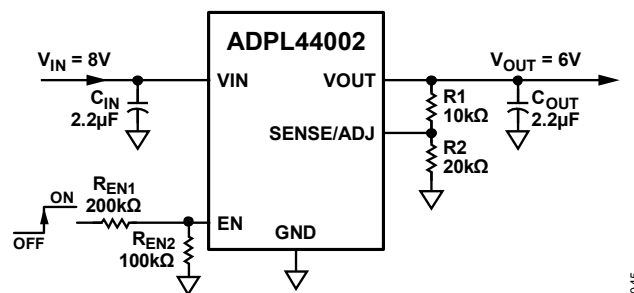

Figure 29. Typical EN Pin Voltage Divider

Figure 28 shows the typical hysteresis of the EN pin. This prevents on/off oscillations that can occur due to noise on the EN pin as it passes through the threshold points.

### Soft Start

The ADPL44002 uses an internal soft start (when the SS pin is left open) to limit the inrush current when the output is enabled. The start-up time for the 3.3V option is approximately 400µs from the time the EN active threshold is crossed to when the output reaches 90% of its final value. As shown in *Figure 30*, the start-up time is independent of the output voltage setting.

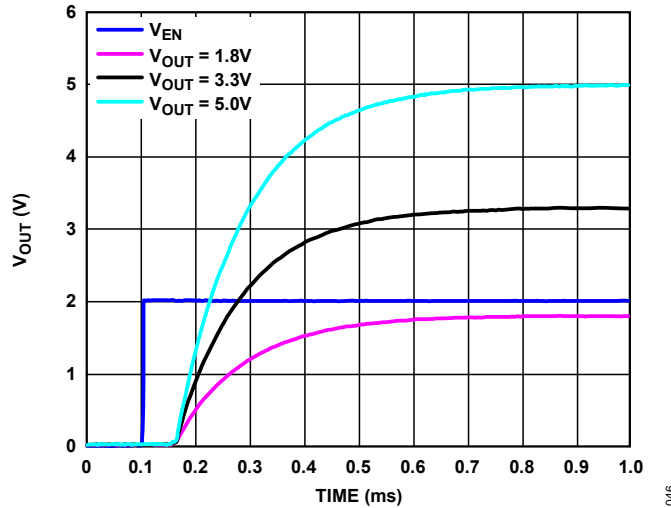

Figure 30. Typical Start-Up Behavior

An external capacitor connected to the SS pin determines the soft start time. The SS pin can be left open for a typical 400µs start-up time. Do not ground this pin. When an external soft start capacitor ( $C_{SS}$ ) is used, the soft start time is determined by the following equation:

$$SS_{TIME} \text{ (sec)} = t_{STARTUP} \text{ (OPEN)} + 6 \times C_{SS} / I_{SS} \quad (6)$$

where:  $t_{STARTUP} \text{ (OPEN)}$  is the start-up time at  $C_{SS} = \text{(OPEN)}$  (typically 400µs).

$C_{SS}$  is the soft start capacitor (F).

$I_{SS}$  is the soft start current (typically 1.15µA).

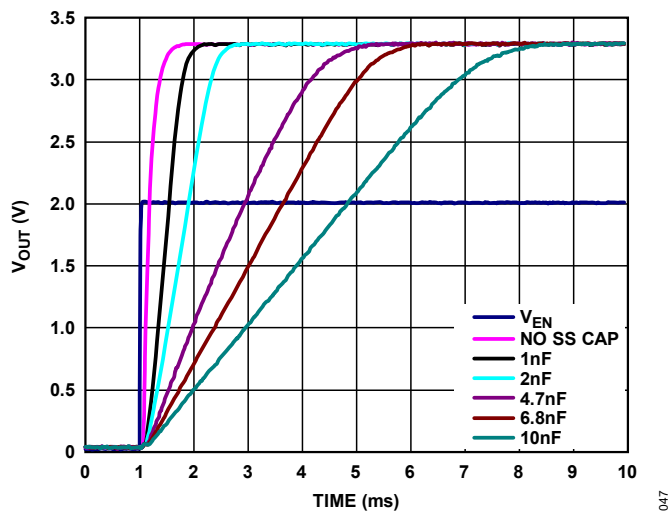

Figure 31. Typical Soft Start Behavior, Different  $C_{SS}$



## Noise Reduction of the ADPL44002 in Adjustable Mode

The ultralow output noise of the ADPL44002 is achieved by keeping the LDO error amplifier in unity gain and setting the reference voltage equal to the output voltage. This architecture does not work for an adjustable output voltage LDO in the conventional sense. However, the ADPL44002 architecture allows any fixed output voltage to be set to a higher voltage with an external voltage divider. For example, a fixed 5V output can be set to a 10V output according to Equation 3 (see [Figure 32](#)):

$$V_{OUT} = 5V(1 + R1/R2)$$

The disadvantage of using the ADPL44002 in this manner is that the output voltage noise is proportional to the output voltage. Therefore, it is best to choose a fixed output voltage that is close to the target voltage to minimize the increase in output noise.

The adjustable LDO circuit can be modified to reduce the output voltage noise to levels close to those of the fixed output ADPL44002. The circuit shown in [Figure 32](#) adds two additional components to the output voltage setting resistor divider.  $C_{NR}$  and  $R_{NR}$  are added in parallel with  $R1$  to reduce the ac gain of the error amplifier.  $R_{NR}$  is chosen to be small with respect to  $R2$ . If  $R_{NR}$  is 1% to 10% of the value of  $R2$ , the minimum ac gain of the error amplifier is approximately 0.1dB to 0.8dB. The actual gain is determined by the parallel combination of  $R_{NR}$  and  $R1$ . This gain ensures that the error amplifier always operates at a slightly greater than unity gain.

$C_{NR}$  is chosen by setting the reactance of  $C_{NR}$  equal to  $R1 - R_{NR}$  at a frequency between 1Hz and 50Hz. This setting places the frequency where the ac gain of the error amplifier is 3dB down from its dc gain.

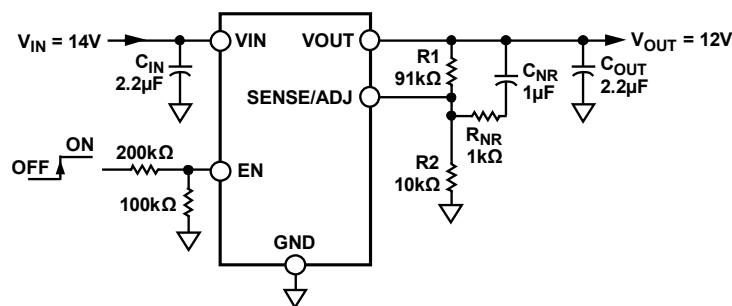

Figure 32. Noise Reduction Modification

### Effect of Noise Reduction on Start-Up Time

The start-up time of the ADPL44002 is affected by the noise reduction network and must be considered in applications where power supply sequencing is critical.

The noise reduction circuit adds a pole in the feedback loop, slowing down the start-up time. The start-up time for an adjustable model with a noise reduction network can be approximated using the following equation:

$$SSNR_{TIME} \text{ (sec)} = 5.5 \times C_{NR} \times (R_{NR} + R1) \quad (7)$$

For a  $C_{NR}$ ,  $R_{NR}$ , and  $R1$  combination of 1µF, 1kΩ, and 91kΩ as shown in [Figure 32](#), the start-up time is approximately 0.5 sec. When  $SSNR_{TIME}$  is greater than  $SS_{TIME}$ ,  $SSNR_{TIME}$  dictates the length of the start-up time instead of the soft start capacitor.

## Current-Limit and Thermal Overload

The ADPL44002 is protected against damage due to excessive power dissipation by current and thermal overload protection circuits. The ADPL44002 is designed to current limit when the output load reaches 360mA (typical). When the output load exceeds 360mA, the output voltage is reduced to maintain a constant current limit.

Thermal overload protection is included, which limits the junction temperature to a maximum of 150°C (typical). Under extreme conditions (that is, high ambient temperature and/or high power dissipation), when the junction temperature starts to rise above 150°C, the output is turned off, reducing the output current to zero. When the junction temperature drops below 135°C, the output is turned on again, and the output current is restored to its operating value.

Consider the case where a hard short from  $V_{OUT}$  to ground occurs. At first, the ADPL44002 current limits, so that only 360mA is conducted into the short. If self heating of the junction is great enough to cause its temperature to rise above 150°C, thermal shutdown activates, turning off the output and reducing the output current to zero. As the junction temperature cools and drops below 135°C, the output turns on and conducts 360mA into the short, again causing the junction temperature to rise above 150°C. This thermal oscillation between 135°C and 150°C causes a current oscillation between 360mA and 0mA that continues as long as the short remains at the output.

Current and thermal limit protections protect the device against accidental overload conditions. For reliable operation, device power dissipation must be externally limited so that the junction temperature does not exceed 125°.

## PRINTED CIRCUIT BOARD LAYOUT CONSIDERATIONS

Heat dissipation from the package can be improved by increasing the amount of copper attached to the pins of the ADPL44002. However, a point of diminishing returns is eventually reached, beyond which an increase in the copper size does not yield significant heat dissipation benefits.

Place the input capacitor as close as possible to the  $V_{IN}$  pin and GND pin. Place the output capacitor as close as possible to the  $V_{OUT}$  and GND pins. The use of 0805 or 1206 size capacitors and resistors achieves the smallest possible footprint solution on boards where area is limited.

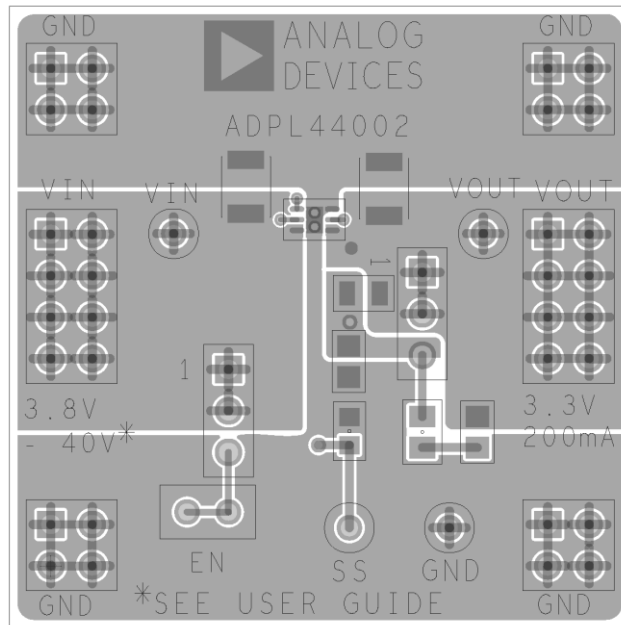

Figure 33. Example LFCSP PCB Layout

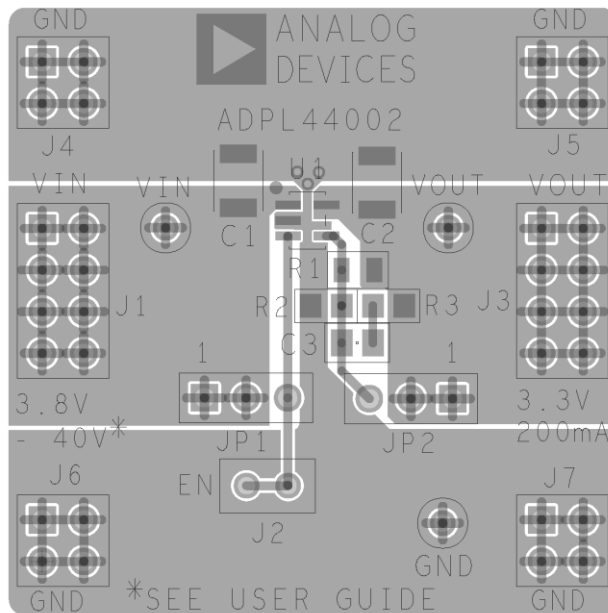

Figure 34. Example TSOT PCB Layout

OUTLINE DIMENSIONS

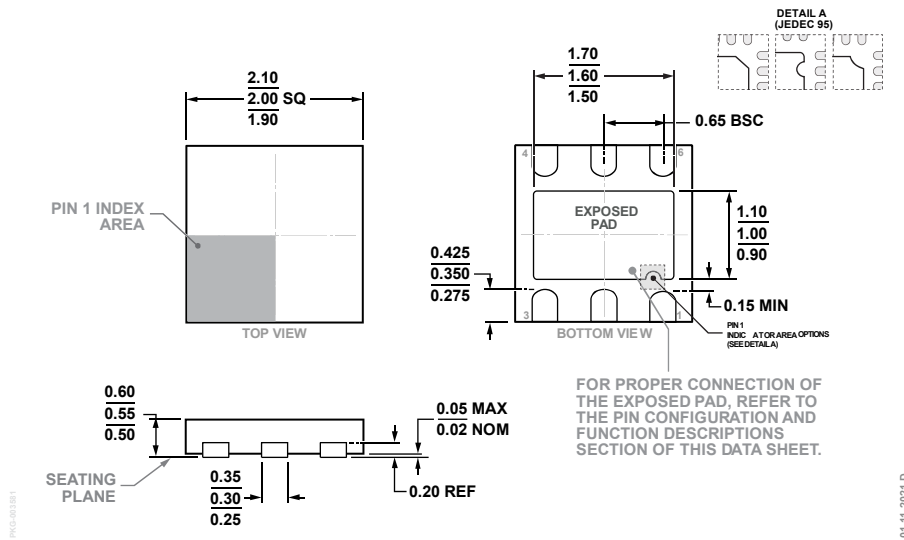

Figure 35. 6-Lead Lead Frame Chip Scale Package [LFCSP] 2.00mm × 2.00mm Body and 0.55mm Package Height (CP-6-3) Dimensions shown in millimeters

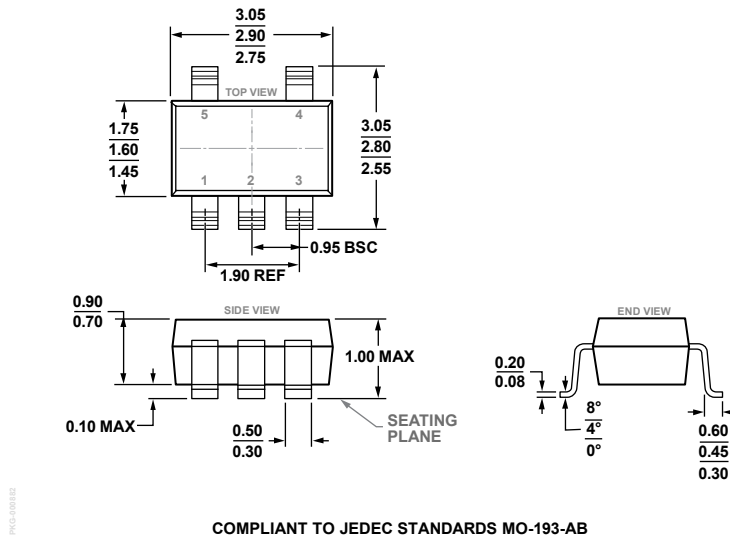

Figure 36. 5-Lead Thin Small Outline Transistor Package [TSOT] (UJ-5) Dimensions shown in millimeters

## ORDERING GUIDE

**Table 6. Ordering Guide**

MODEL <sup>1</sup>	TEMPERATURE RANGE	PACKAGE DESCRIPTION	PACKING QUANTITY	PACKAGE OPTION	MARKING CODE
ADPL44002ACPZN2.5-R7	-40°C to +125°C	6-Lead LFCSP (2mm x 2mm w/EP)	Reel, 3000	CP-6-3	LXM
ADPL44002ACPZN3.3-R7	-40°C to +125°C	6-Lead LFCSP (2mm x 2mm w/EP)	Reel, 3000	CP-6-3	LXN
ADPL44002ACPZN5.0-R7	-40°C to +125°C	6-Lead LFCSP (2mm x 2mm w/EP)	Reel, 3000	CP-6-3	LXP
ADPL44002ACPZN-R7	-40°C to +125°C	6-Lead LFCSP (2mm x 2mm w/EP)	Reel, 3000	CP-6-3	LXQ
ADPL44002AUJZ1.8-R7	-40°C to +125°C	5-Lead TSOT	Reel, 3000	UJ-5	LXR
ADPL44002AUJZ2.5-R7	-40°C to +125°C	5-Lead TSOT	Reel, 3000	UJ-5	LXM
ADPL44002AUJZ3.3-R7	-40°C to +125°C	5-Lead TSOT	Reel, 3000	UJ-5	LXN
ADPL44002AUJZ5.0-R7	-40°C to +125°C	5-Lead TSOT	Reel, 3000	UJ-5	LXP
ADPL44002AUJZ-R7	-40°C to +125°C	5-Lead TSOT	Reel, 3000	UJ-5	LXQ

<sup>1</sup> Z = RoHS Compliant Part

**Table 7. Output Voltage Options**

MODEL	OUTPUT VOLTAGE (V) <sup>1</sup>
ADPL44002ACPZN2.5-R7	2.5
ADPL44002ACPZN3.3-R7	3.3
ADPL44002ACPZN5.0-R7	5.0
ADPL44002ACPZN-R7	Adjustable (1.2 V)
ADPL44002AUJZ1.8-R7	1.8
ADPL44002AUJZ2.5-R7	2.5
ADPL44002AUJZ3.3-R7	3.3
ADPL44002AUJZ5.0-R7	5.0
ADPL44002AUJZ-R7	Adjustable (1.2 V)

<sup>1</sup> For additional voltage options, contact a local Analog Devices, Inc., sales or distribution representative.

**Table 8. Evaluation Boards**

MODEL <sup>1,2</sup>	PACKAGE DESCRIPTION
EVAL-ADPL44002CP-AZ	LFCSP Evaluation Board
EVAL-ADPL44002UJ-AZ	TSOT Evaluation Board

<sup>1</sup> Z = RoHS Compliant Part

<sup>2</sup> The evaluation boards are preconfigured with an adjustable ADPL44002.

**REVISION HISTORY**

<b>REVISION NUMBER</b>	<b>REVISION DATE</b>	<b>DESCRIPTION</b>	<b>PAGES CHANGED</b>
0	10/24	Initial Release for Market Intro	—

ALL INFORMATION CONTAINED HEREIN IS PROVIDED "AS IS" WITHOUT REPRESENTATION OR WARRANTY. NO RESPONSIBILITY IS ASSUMED BY ANALOG DEVICES FOR ITS USE, NOR FOR ANY INFRINGEMENTS OF PATENTS OR OTHER RIGHTS OF THIRD PARTIES THAT MAY RESULT FROM ITS USE. SPECIFICATIONS ARE SUBJECT TO CHANGE WITHOUT NOTICE. NO LICENCE, EITHER EXPRESSED OR IMPLIED, IS GRANTED UNDER ANY ADI PATENT RIGHT, COPYRIGHT, MASK WORK RIGHT, OR ANY OTHER ADI INTELLECTUAL PROPERTY RIGHT RELATING TO ANY COMBINATION, MACHINE, OR PROCESS, IN WHICH ADI PRODUCTS OR SERVICES ARE USED. TRADEMARKS AND REGISTERED TRADEMARKS ARE THE PROPERTY OF THEIR RESPECTIVE OWNERS. ALL ANALOG DEVICES PRODUCTS CONTAINED HEREIN ARE SUBJECT TO RELEASE AND AVAILABILITY.

# Mouser Electronics

Authorized Distributor

Click to View Pricing, Inventory, Delivery & Lifecycle Information:

[Analog Devices Inc.:](#)

[ADPL44002AUJZ-3.3-R7](#) [ADPL44002AUJZ-5.0-R7](#) [ADPL44002ACPZN2.5-R7](#) [ADPL44002AUJZ-R7](#)  
[ADPL44002AUJZ-2.5-R7](#) [ADPL44002ACPZN-R7](#) [ADPL44002ACPZN5.0-R7](#) [ADPL44002AUJZ-1.8-R7](#)  
[ADPL44002ACPZN3.3-R7](#)