

# OSRAM SFH 4182BS

## Datasheet

Published by **ams-OSRAM AG**

Tobelbader Strasse 30, 8141 Premstaetten, Austria

Phone +43 3136 500-0

[ams-osram.com](http://ams-osram.com)

© All rights reserved



OSLON® P1616 Lens

# SFH 4182BS

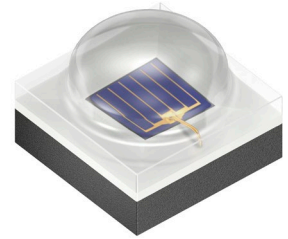

## Applications

- Access Control & Security
- Authentication
- Eye, face and hand tracking
- Factory Automation
- Home & Building Automation
- Medical Lighting

## Features

- Package: clear silicone
- ESD: 2 kV acc. to ANSI/ESDA/JEDEC JS-001 (HBM)
- IR lightsource with high efficiency
- Double stack emitter

## Ordering Information

Type	Radiant intensity <sup>1)2)</sup> $I_F = 1000 \text{ mA}; t_p = 10 \text{ ms}$ $I_e$	Radiant intensity <sup>1)</sup> typ. $I_F = 1000 \text{ mA}; t_p = 10 \text{ ms}$ $I_e$	Ordering Code
SFH 4182BS-CB2DB1-11	400 ... 630 mW/sr	455 mW/sr	Q65113A6124
SFH 4182BS-CB2DB1-1113	400 ... 630 mW/sr	455 mW/sr	Q65113A8777
SFH 4182BS-CB2DB1-13	400 ... 630 mW/sr	455 mW/sr	Q65113A7976

## Maximum Ratings

$T_s = 25\text{ °C}$

Parameter	Symbol		Values
Operating temperature	$T_{op}$	min.	-40 °C
		max.	105 °C
Storage temperature	$T_{stg}$	min.	-40 °C
		max.	105 °C
Junction temperature	$T_j$	max.	145 °C
Forward current	$I_F$	min.	10 mA
		max.	1000 mA
Forward current pulsed $t_p \leq 1.1\text{ ms}$ ; $D \leq 0.005$	$I_{F\ pulse}$	max.	2 A
Reverse voltage <sup>3)</sup>	$V_R$	max.	5 V
ESD withstand voltage acc. to ANSI/ESDA/JEDEC JS-001 (HBM)	$V_{ESD}$	max.	2 kV

Note: The maximum forward current dimming range shall not be larger than 10.

## Characteristics

$I_F = 1000 \text{ mA}$ ;  $t_p = 10 \text{ ms}$ ;  $T_s = 25 \text{ }^\circ\text{C}$

Parameter	Symbol		Values
Peak wavelength	$\lambda_{\text{peak}}$	typ.	940 nm
Centroid wavelength <sup>4)</sup>	$\lambda_{\text{centroid}}$	min. max.	912 nm 950 nm
Spectral bandwidth at 50% $I_{\text{rel,max}}$ (FWHM)	$\Delta\lambda$	typ.	37 nm
Half angle	$\varphi$	typ.	65 °
Dimensions of chip area	L x W	typ.	0.73 x 0.73 mm x mm
Rise time (10% / 90%) $I_F = 2 \text{ A}$ ; $R_L = 5 \text{ } \Omega$	$t_r$	typ.	12 ns
Fall time (10% / 90%) $I_F = 2 \text{ A}$ ; $R_L = 5 \text{ } \Omega$	$t_f$	typ.	11.5 ns
Forward voltage <sup>5)</sup>	$V_F$	typ. max.	2.8 V 3.2 V
Forward voltage <sup>5)</sup> $I_F = 2 \text{ A}$ ; $t_p = 100 \text{ } \mu\text{s}$	$V_F$	typ. max.	3.0 V 3.7 V
Reverse current <sup>3)</sup> $V_R = 5 \text{ V}$	$I_R$	typ. max.	0.01 $\mu\text{A}$ 10 $\mu\text{A}$
Total radiant flux <sup>6)</sup> $I_F = 1000 \text{ mA}$ ; $t_p = 100 \text{ } \mu\text{s}$	$\Phi_e$	typ.	1650 mW
Thermal resistance junction solder point electrical <sup>7)</sup> with efficiency $\eta_e = 59 \text{ } \%$	$R_{\text{thJS elec.}}$	typ. max.	5.3 K / W 6.4 K / W

## Brightness Groups

Group	Radiant intensity <sup>1)2)</sup> $I_F = 1000 \text{ mA}; t_p = 10 \text{ ms}$ min.	Radiant intensity <sup>1)2)</sup> $I_F = 1000 \text{ mA}; t_p = 10 \text{ ms}$ max.
	$I_e$	$I_e$
CB2	400 mW/sr	450 mW/sr
DA1	450 mW/sr	500 mW/sr
DA2	500 mW/sr	560 mW/sr
DB1	560 mW/sr	630 mW/sr

## Centroid Wavelength

Group	Centroid wavelength <sup>4)</sup> $I_F = 1000 \text{ mA}; t_p = 10 \text{ ms}$ min.	Centroid wavelength <sup>4)</sup> $I_F = 1000 \text{ mA}; t_p = 10 \text{ ms}$ max.
	$\lambda_{\text{centroid}}$	$\lambda_{\text{centroid}}$
11	912 nm	925 nm
12	925 nm	930 nm
13	930 nm	950 nm

**Relative Spectral Emission** 8), 9)

Centroid wavelength 920 nm

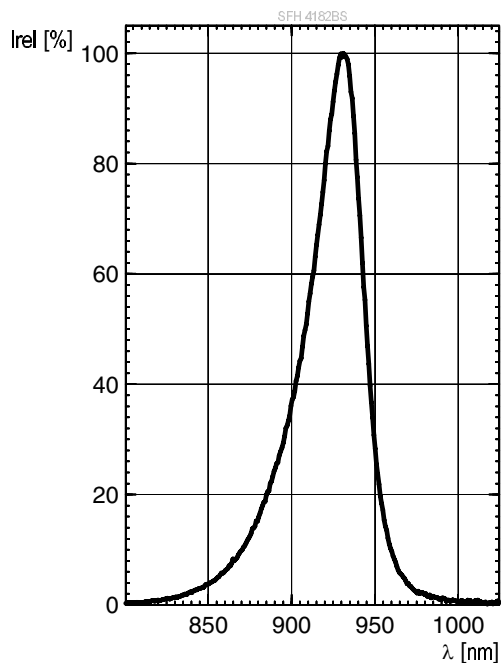

**Relative Spectral Emission** 8), 9)

Centroid wavelength 940 nm

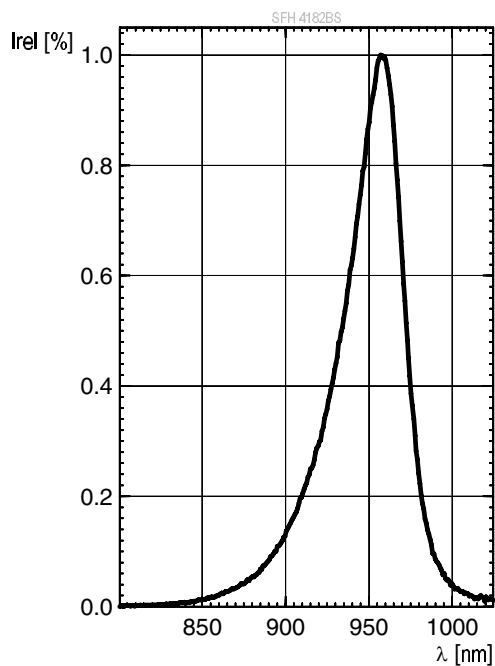

### Radiation Characteristics 8), 9)

$$I_{e,rel} = f(\varphi)$$

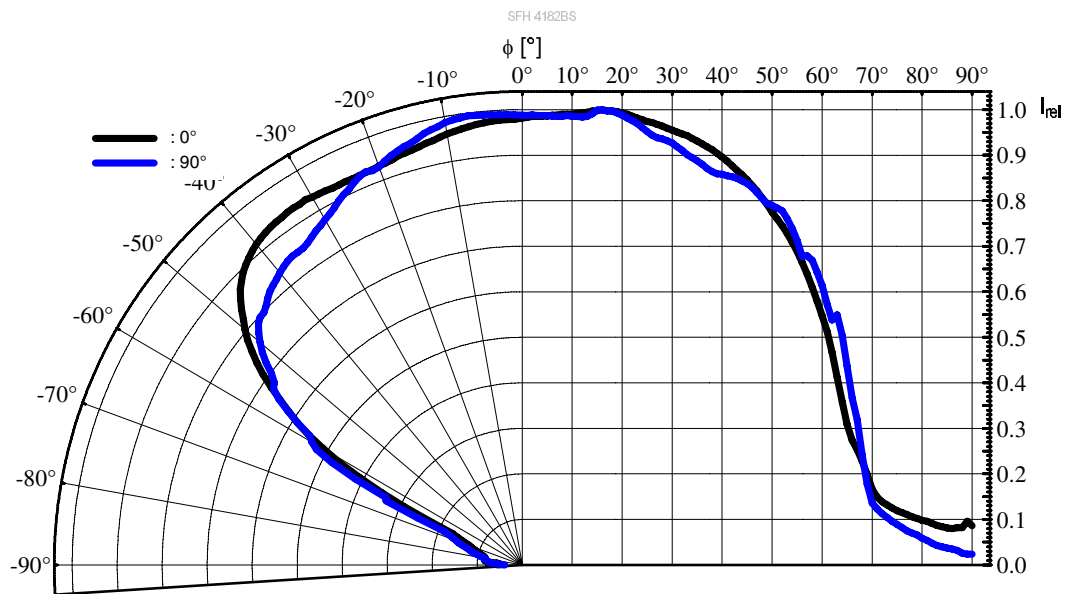



### Forward current <sup>8), 9)</sup>

$I_F = f(V_F)$ ; single pulse;  $t_p = 100 \mu s$

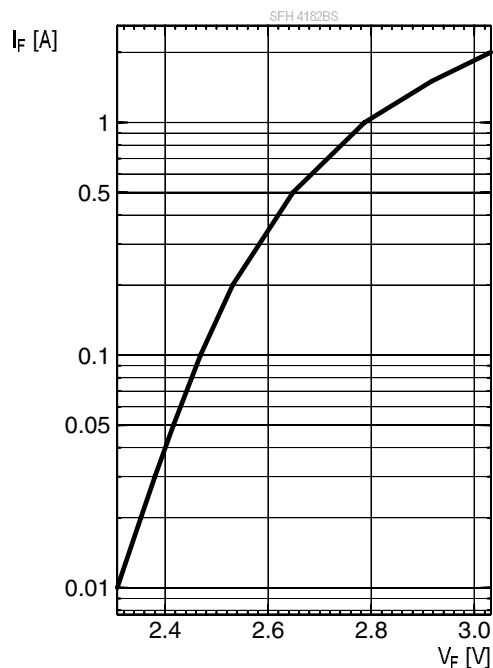

### Relative Total Radiant Flux <sup>8), 9)</sup>

$\Phi_e / \Phi_e(1000 \text{ mA}) = f(I_F)$ ; single pulse;  $t_p = 100 \mu s$

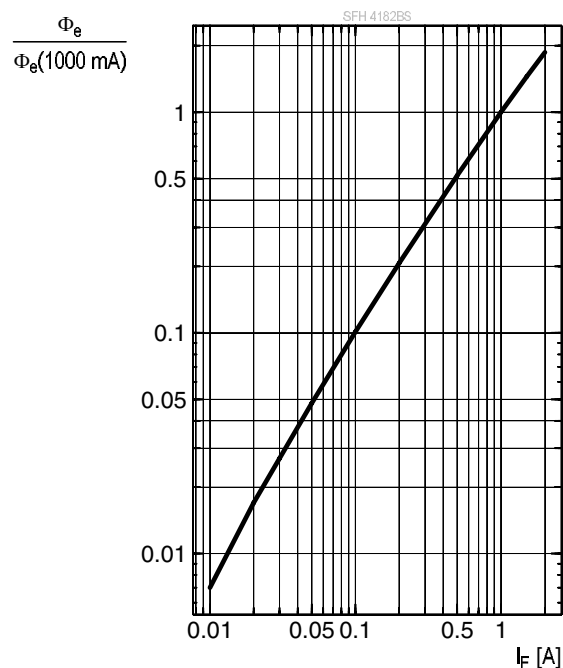

### Forward Voltage <sup>8)</sup>

$$V_F = f(T_S); I_F = 1000\text{mA}; t_p = 100\mu\text{s}$$

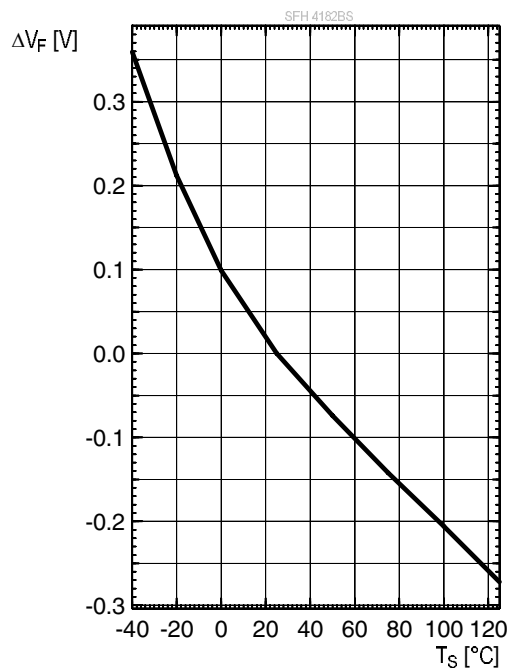

### Relative Total Radiant Flux <sup>8)</sup>

$$\Phi_{\text{rel}} = f(T_S); I_F = 1000\text{mA}; t_p = 100\mu\text{s}$$

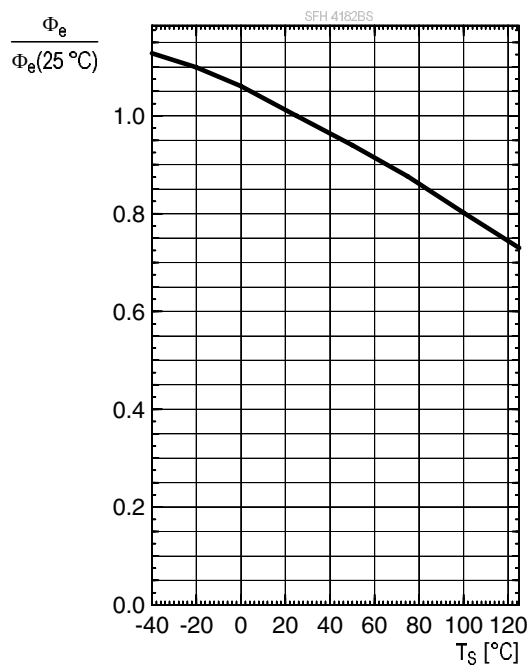

### Centroid Wavelength <sup>8)</sup>

$$\lambda_{\text{centroid}} = f(T_S); I_F = 1000\text{mA}; t_p = 100\mu\text{s}$$

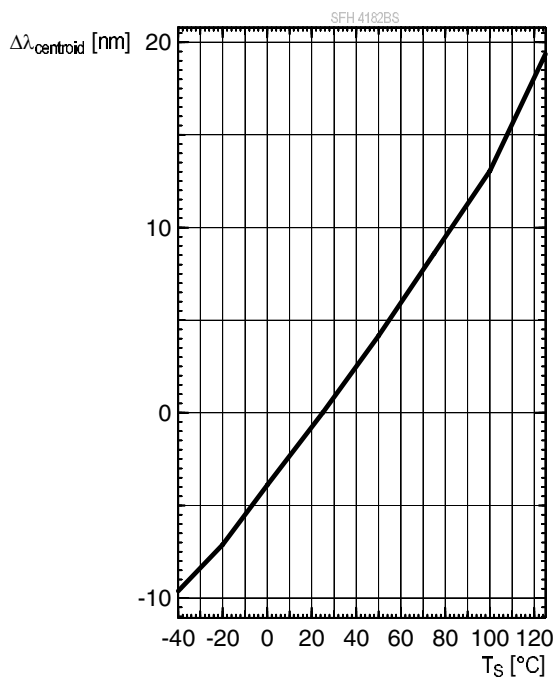

### Max. Permissible Forward Current

$$I_F = f(T_S)$$

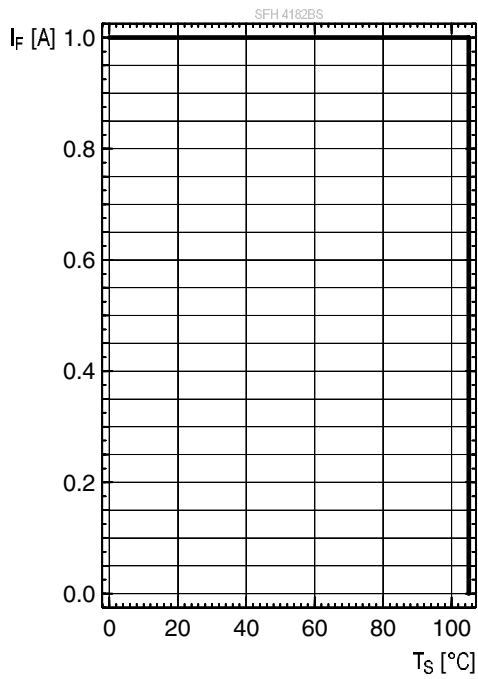

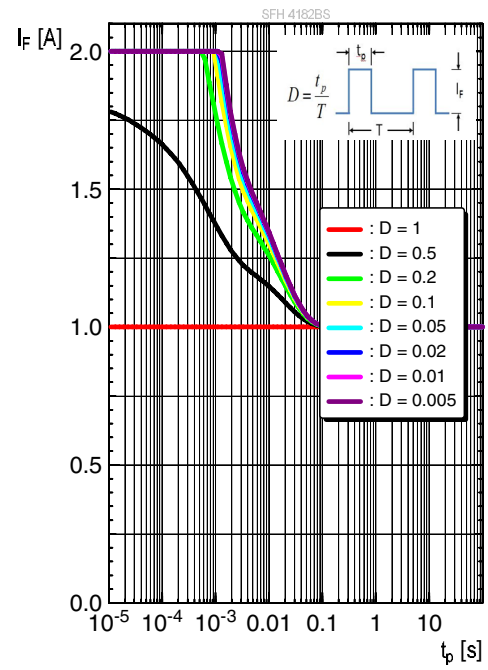

### Permissible Pulse Handling Capability

$$I_F = f(t_p); \text{ duty cycle } D = \text{parameter}; T_S = 85^\circ\text{C}$$

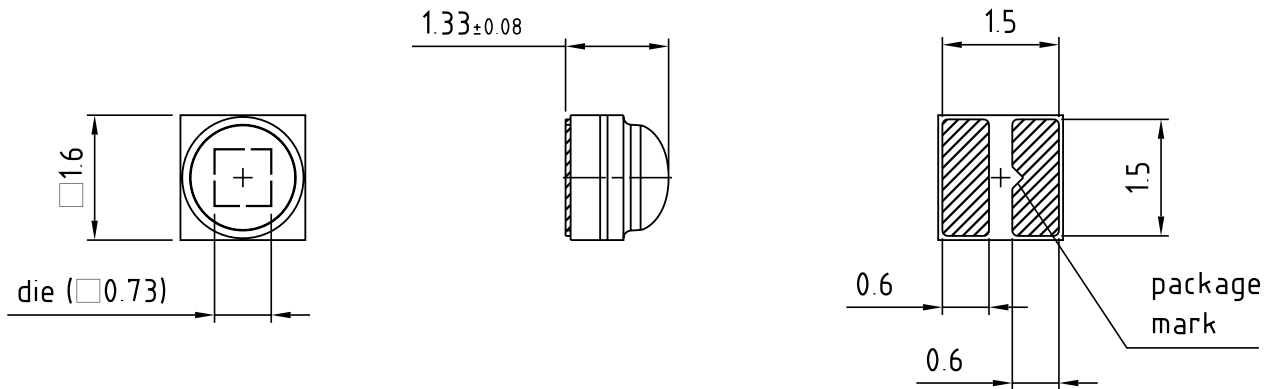

## Dimensional Drawing <sup>10)</sup>



general tolerance  $\pm 0.05$   
lead finish Au 

C63062-A4429-A1...-05

## Further Information:

**Approximate Weight:** 7.0 mg

**Package marking:** Cathode

Recommended Solder Pad <sup>10)</sup>

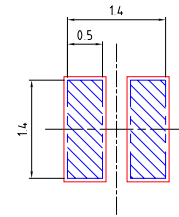
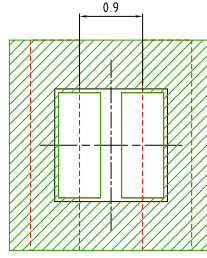
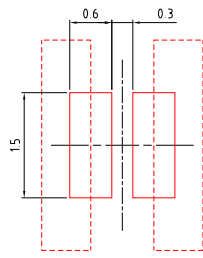

□ foot print □ Cu area

▨ solder resist

▨ solder stencil  
recommended stencil  
thickness 120µm

Component Location on Pad

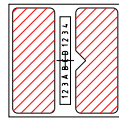
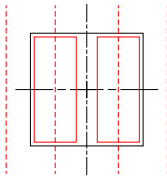

E062.3010.272 -02

## Reflow Soldering Profile

Product complies to MSL Level 2 acc. to JEDEC J-STD-020E

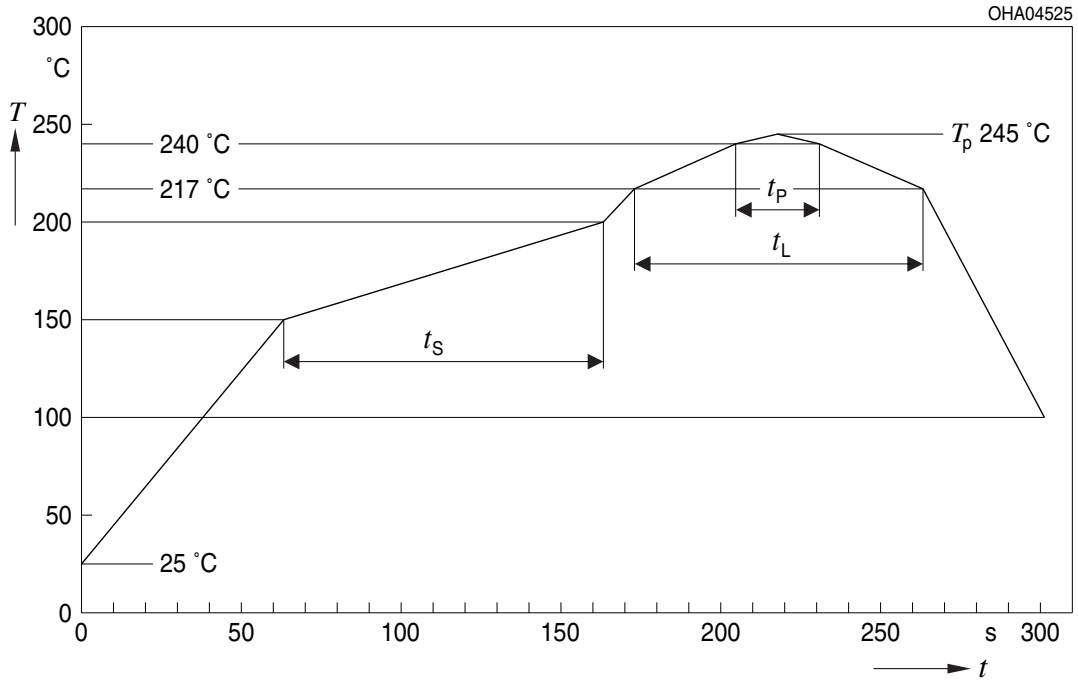

Profile Feature	Symbol	Pb-Free (SnAgCu) Assembly			Unit
		Minimum	Recommendation	Maximum	
Ramp-up rate to preheat <sup>*)</sup> 25 °C to 150 °C			2	3	K/s
Time $t_s$ $T_{Smin}$ to $T_{Smax}$	$t_s$	60	100	120	s
Ramp-up rate to peak <sup>*)</sup> $T_{Smax}$ to $T_p$			2	3	K/s
Liquidus temperature	$T_L$		217		°C
Time above liquidus temperature	$t_L$		80	100	s
Peak temperature	$T_p$		245	260	°C
Time within 5 °C of the specified peak temperature $T_p - 5$ K	$t_p$	10	20	30	s
Ramp-down rate* $T_p$ to 100 °C			3	6	K/s
Time 25 °C to $T_p$				480	s

All temperatures refer to the center of the package, measured on the top of the component

\* slope calculation  $DT/Dt$ :  $Dt$  max. 5 s; fulfillment for the whole T-range

Taping <sup>10)</sup>

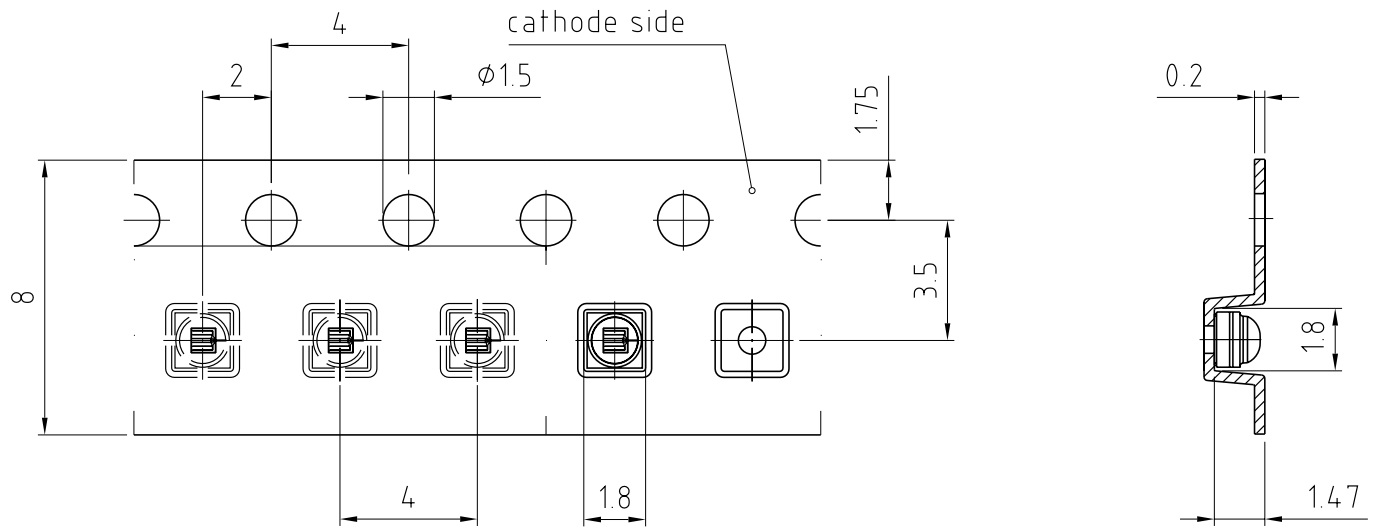

C69062-A0045-B6-01

## Tape and Reel <sup>11)</sup>



### Reel Dimensions

A	W	$N_{\min}$	$W_1$	$W_{2\max}$	Pieces per PU
180 mm	$8 + 0.3 / - 0.1$ mm	60 mm	$8.4 + 2$ mm	14.4 mm	3000



### Barcode-Product-Label (BPL)

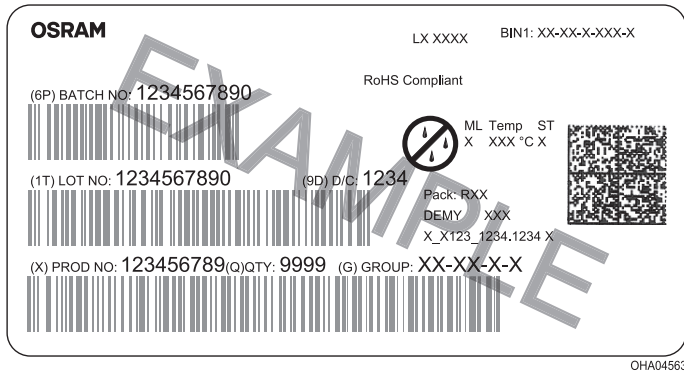

### Dry Packing Process and Materials

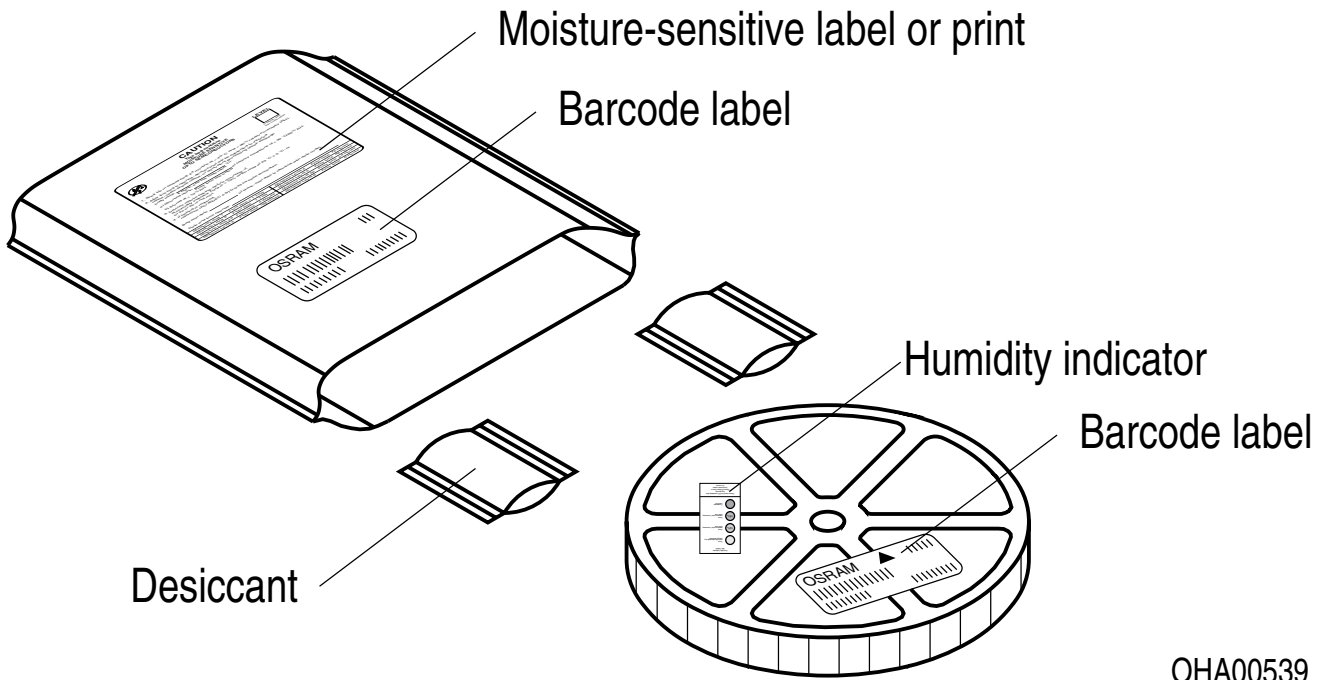

Moisture-sensitive product is packed in a dry bag containing desiccant and a humidity card according JEDEC-STD-033.

---

## Notes

The evaluation of eye safety occurs according to the standard IEC 62471:2006 (photo biological safety of lamps and lamp systems). Within the risk grouping system of this IEC standard, the device specified in this data sheet falls into **exempt risk group - Exempt**.

Subcomponents of this device contain, in addition to other substances, metal filled materials including silver. Metal filled materials can be affected by environments that contain traces of aggressive substances. Therefore, we recommend that customers minimize device exposure to aggressive substances during storage, production, and use. Devices that showed visible discoloration when tested using the described tests above did show no performance deviations within failure limits during the stated test duration. Respective failure limits are described in the IEC60810.

### Handling:

Solvents, water, liquids, non-conductive plastics and glues are not allowed near the device, because solvents and other liquids could emerge and damage the product.

For further application related information please visit <https://ams-osram.com/support/application-notes>

## Disclaimer

### Attention please!

The information describes the type of component and shall not be considered as assured characteristics. Terms of delivery and rights to change design reserved. Due to technical requirements components may contain dangerous substances.

For information on the types in question please contact our Sales Organization.

If printed or downloaded, please find the latest version on our website.

### Packing

Please use the recycling operators known to you. We can also help you – get in touch with your nearest sales office. By agreement we will take packing material back, if it is sorted. You must bear the costs of transport. For packing material that is returned to us unsorted or which we are not obliged to accept, we shall have to invoice you for any costs incurred.

### Product and functional safety devices/applications or medical devices/applications

Our components are not developed, constructed or tested for the application as safety relevant component or for the application in medical devices.

Our products are not qualified at module and system level for such application.

In case buyer – or customer supplied by buyer – considers using our components in product safety devices/ applications or medical devices/applications, buyer and/or customer has to inform our local sales partner immediately and we and buyer and /or customer will analyze and coordinate the customer-specific request between us and buyer and/or customer.

---

## Glossary

- 1) **Radiant intensity:** Measured at a solid angle of  $\Omega = 0.01$  sr
- 2) **Brightness:** The brightness values are measured with a tolerance of  $\pm 11\%$ .
- 3) **Reverse Operation:** This product is intended to be operated applying a forward current within the specified range. Applying any continuous reverse bias or forward bias below the voltage range of light emission shall be avoided because it may cause migration which can change the electro-optical characteristics or damage the LED.
- 4) **Wavelength:** The wavelengths are measured with a tolerance of  $\pm 1$  nm.
- 5) **Forward Voltage:** The forward voltages are measured with a tolerance of  $\pm 0.1$  V.
- 6) **Total radiant flux:** Measured with integrating sphere.
- 7) **Thermal resistance:** junction - soldering point, of the device only, mounted on an ideal heatsink (e.g. metal block)
- 8) **Typical Values:** Due to the special conditions of the manufacturing processes of semiconductor devices, the typical data or calculated correlations of technical parameters can only reflect statistical figures. These do not necessarily correspond to the actual parameters of each single product, which could differ from the typical data and calculated correlations or the typical characteristic line. If requested, e.g. because of technical improvements, these typ. data will be changed without any further notice.
- 9) **Testing temperature:** TA = 25°C (unless otherwise specified)
- 10) **Tolerance of Measure:** Unless otherwise noted in drawing, tolerances are specified with  $\pm 0.1$  and dimensions are specified in mm.
- 11) **Tape and Reel:** All dimensions and tolerances are specified acc. IEC 60286-3 and specified in mm.

---

## Revision History

Version	Date	Change
1.0	2024-08-13	Characteristics Electro - Optical Characteristics (Diagrams)
1.1	2024-12-11	Notes Brightness and Wavelength Groups

---



EU RoHS and China RoHS compliant product

此产品符合欧盟 RoHS 指令的要求；  
按照中国的相关法规和标准，  
不含有毒有害物质或元素。

**Published by ams-OSRAM AG**

Tobelbader Strasse 30, 8141 Premstaetten, Austria

Phone +43 3136 500-0

[ams-osram.com](http://ams-osram.com)

© All rights reserved

**am** 

**OSRAM**

# Mouser Electronics

Authorized Distributor

Click to View Pricing, Inventory, Delivery & Lifecycle Information:

[ams OSRAM:](#)

[SFH 4182BS-CB2DB1-11](#) [SFH 4182BS-CB2DB1-13](#) [SFH 4182BS-CB2DB1-1113](#)