

OSRAM GW JTLMS3.EM

Datasheet

Published by **ams-OSRAM AG**

Tobelbader Strasse 30, 8141 Premstaetten, Austria

Phone +43 3136 500-0

ams-osram.com

© All rights reserved



DURIS® E 2835

GW JTLMS3.EM

The pre-molded PPA 2835 LED version with standard 2835 footprint provides competitive value in application and system level. The DURIS® E 2835 0.2W SOFTLINEAR combines good mechanical flexibility and a wide beam angle into a compact format (2.8 mm x 3.5 mm). This product fits well to flexible strips general lighting application. DURIS® E 2835 never fails to impress with its performance on system level.



Applications

- Indoor Lighting

Features

- Package: white SMT package, colored diffused silicone resin
- Typ. Radiation: 120° (Lambertian emitter)
- Color temperature: 2200K - 6500K
- CRI: 80 (min.), 81 (typ.), R9: 0 (min.)
- Lumen maintenance: Test results according to IESNA LM-80 available
- ESD: 2 kV acc. to ANSI/ESDA/JEDEC JS-001 (HBM, Class 2)
- Luminous Flux: typ. 25 lm @ 3000 K
- Luminous efficacy: typ. 132 lm/W @ 3000 K

Ordering Information

Type	Color temperature	McAdams steps	Luminous Flux ¹⁾ $I_F = 60 \text{ mA}$ Φ_v	Ordering Code
GW JTLMS3.EM-G6G8-XX310-1	2200 K	SDCM 3	19.5 ... 24.0 lm	Q65113A8855
GW JTLMS3.EM-G7G9-XX39-1	2400 K	SDCM 3	21.0 ... 25.5 lm	Q65113A8856
GW JTLMS3.EM-G8GV-XX38-1	2700 K	SDCM 3	22.5 ... 27.0 lm	Q65113A8851
GW JTLMS3.EM-G9GW-XX37-1	3000 K	SDCM 3	24.0 ... 28.5 lm	Q65113A8852
GW JTLMS3.EM-G9GW-XX36-1	3500 K	SDCM 3	24.0 ... 28.5 lm	Q65113A8853
GW JTLMS3.EM-G9GW-XX35-1	4000 K	SDCM 3	24.0 ... 28.5 lm	Q65113A8854
GW JTLMS3.EM-G9GW-XX33-1	5000 K	SDCM 3	24.0 ... 28.5 lm	Q65113A8859
GW JTLMS3.EM-G9GW-XX32-1	5700 K	SDCM 3	24.0 ... 28.5 lm	Q65113A8861
GW JTLMS3.EM-G9GW-XX31-1	6500 K	SDCM 3	24.0 ... 28.5 lm	Q65113A8858
GW JTLMS3.EM-G6G9-XX510-1	2200 K	SDCM 5	19.5 ... 25.5 lm	Q65113A6702
GW JTLMS3.EM-G6GV-XX59-1	2400 K	SDCM 5	19.5 ... 27.0 lm	Q65113A8675
GW JTLMS3.EM-G8GW-XX58-1	2700 K	SDCM 5	22.5 ... 28.5 lm	Q65113A6707
GW JTLMS3.EM-G9H1-XX57-1	3000 K	SDCM 5	24.0 ... 30.0 lm	Q65113A6703
GW JTLMS3.EM-G9H1-XX56-1	3500 K	SDCM 5	24.0 ... 30.0 lm	Q65113A6711
GW JTLMS3.EM-G9H1-XX55-1	4000 K	SDCM 5	24.0 ... 30.0 lm	Q65113A6704
GW JTLMS3.EM-G9H1-XX53-1	5000 K	SDCM 5	24.0 ... 30.0 lm	Q65113A6709
GW JTLMS3.EM-G9H1-XX52-1	5700 K	SDCM 5	24.0 ... 30.0 lm	Q65113A6705
GW JTLMS3.EM-G9H1-XX51-1	6500 K	SDCM 5	24.0 ... 30.0 lm	Q65113A6708

Maximum Ratings

Parameter	Symbol		Values
Operating Temperature	T_{op}	min.	-40 °C
		max.	100 °C
Storage Temperature	T_{stg}	min.	-40 °C
		max.	100 °C
Junction Temperature	T_j	max.	105 °C
Forward Current $T_j = 25\text{ °C}$	I_F	min.	10 mA
		max.	90 mA
Reverse voltage ²⁾	V_R		Not designed for reverse operation
ESD withstand voltage acc. to ANSI/ESDA/JEDEC JS-001 (HBM, Class 2)	V_{ESD}		2 kV

Note: Ensure the appropriate derating current is being used in order to maintain a junction temperature which is lower than the maximum allowable limit.

Characteristics

$I_F = 60 \text{ mA}$; $T_J = 25 \text{ °C}$

Parameter	Symbol		Values
Viewing angle at 50% I_V	2ϕ	typ.	120 °
Forward Voltage ³⁾ $I_F = 60 \text{ mA}$	V_F	min. typ. max.	3.00 V 3.15 V 3.30 V
Reverse current ²⁾	I_R		Not designed for reverse operation
Color Rendering Index ⁴⁾	CRI	min. typ.	80 81
Color Rendering Index (R9) ⁴⁾	CRI (R9)	min.	0
Electrical thermal resistance junction/solderpoint with efficiency $\eta_e = 44 \%$	$R_{thJS \text{ elec.}}$	typ.	60 K / W

Brightness Groups

Group	Luminous Flux ¹⁾ $I_F = 60 \text{ mA}$ min. Φ_V	Luminous Flux ¹⁾ $I_F = 60 \text{ mA}$ max. Φ_V
G6	19.5 lm	21.0 lm
G7	21.0 lm	22.5 lm
G8	22.5 lm	24.0 lm
G9	24.0 lm	25.5 lm
GV	25.5 lm	27.0 lm
GW	27.0 lm	28.5 lm
H1	28.5 lm	30.0 lm

Forward Voltage Groups

Group	Forward Voltage ³⁾ $I_F = 60 \text{ mA}$ min. V_F	Forward Voltage ³⁾ $I_F = 60 \text{ mA}$ max. V_F
M1	3.00 V	3.10 V
M2	3.10 V	3.20 V
N1	3.20 V	3.30 V

Chromaticity Coordinate Groups ⁵⁾

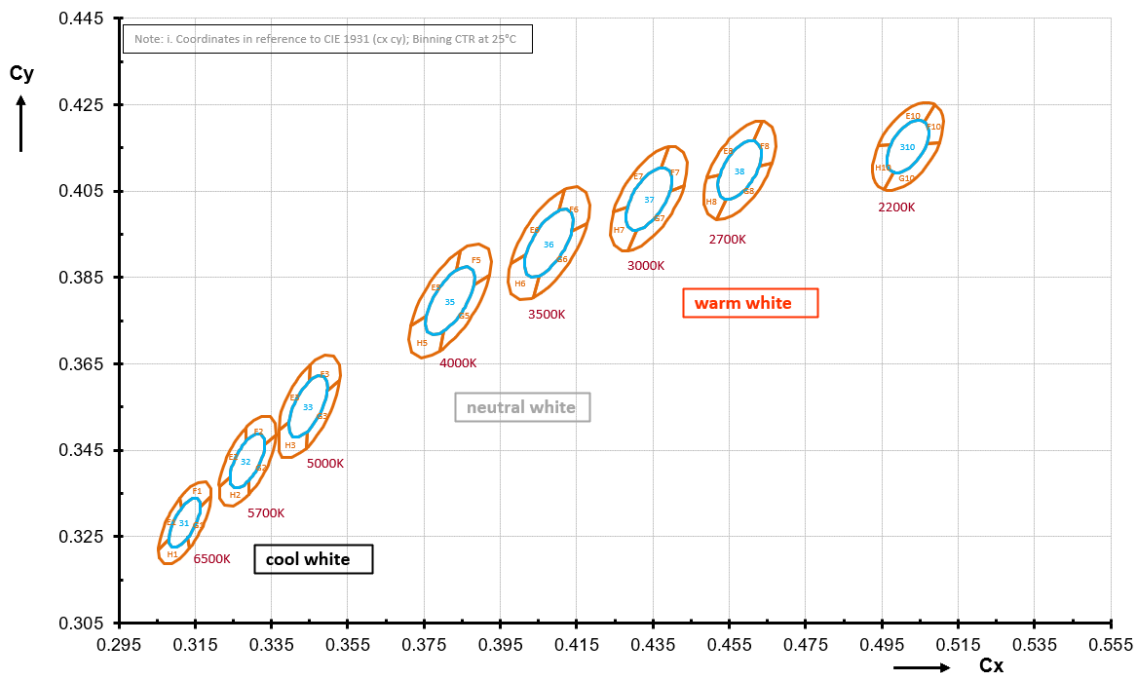

Chromaticity Coordinate Groups

CCT	Center Cx	Center Cy	3step a	3step b	5step a	5step b	∅
2200 K	0.5020	0.4156	0.0072	0.004	0.012	0.0067	39.9
2700 K	0.4577	0.4098	0.008	0.0041	0.0133	0.0068	54.1
3000 K	0.4339	0.4032	0.0086	0.0042	0.0142	0.0069	53.7
3500 K	0.4077	0.3929	0.0093	0.0042	0.0155	0.0069	53.9
4000 K	0.3818	0.3796	0.0094	0.0041	0.0157	0.0068	53.4
5000 K	0.3446	0.3551	0.0081	0.0035	0.0135	0.0059	59.8
5700 K	0.3287	0.3425	0.0072	0.0032	0.0119	0.0052	58.8
6500 K	0.3123	0.3282	0.0066	0.0027	0.011	0.0045	58.1

CCT	Group	1		2		3		4		5	
		Cx	Cy	Cx	Cy	Cx	Cy	Cx	Cy	Cx	Cy
2200 K	E	0.5088	0.4249	0.4941	0.4156	0.4973	0.4157	0.5061	0.4210		
	F	0.5088	0.4249	0.5101	0.4161	0.5068	0.4160	0.5061	0.4210		
	G	0.5101	0.4161	0.4955	0.4054	0.4981	0.4093	0.5068	0.4158		
	H	0.4981	0.4093	0.4973	0.4157	0.4941	0.4156	0.4955	0.4054		
2400 K	E	0.4846	0.4158	0.4693	0.4056	0.4728	0.4057	0.4820	0.4119		
	F	0.4846	0.4158	0.4869	0.4063	0.4834	0.4061	0.4820	0.4119		
	G	0.4869	0.4063	0.4710	0.3961	0.4739	0.4000	0.4834	0.4061		
	H	0.4739	0.4000	0.4710	0.3961	0.4693	0.4056	0.4728	0.4057		
2700 K	E	0.4637	0.4212	0.4491	0.4081	0.4526	0.4088	0.4613	0.4166		
	F	0.4637	0.4212	0.4663	0.4115	0.4628	0.4108	0.4613	0.4166		
	G	0.4663	0.4115	0.4517	0.3984	0.4541	0.4030	0.4628	0.4108		
	H	0.4541	0.4030	0.4526	0.4088	0.4491	0.4081	0.4517	0.3984		
3000 K	E	0.4393	0.4153	0.4246	0.4002	0.4283	0.4014	0.4371	0.4105		
	F	0.4393	0.4153	0.4432	0.4062	0.4395	0.4050	0.4371	0.4105		
	G	0.4432	0.4062	0.4285	0.3911	0.4307	0.3960	0.4395	0.4050		
	H	0.4307	0.3960	0.4283	0.4014	0.4246	0.4002	0.4285	0.3911		
3500 K	E	0.4118	0.4054	0.3977	0.3883	0.4017	0.3902	0.4102	0.4004		
	F	0.4118	0.4054	0.4177	0.3975	0.4137	0.3956	0.4102	0.4004		
	G	0.4177	0.3975	0.4036	0.3804	0.4052	0.3854	0.4137	0.3956		
	H	0.4052	0.3854	0.4017	0.3902	0.3977	0.3883	0.4036	0.3804		
4000 K	E	0.3845	0.3913	0.3714	0.3737	0.3756	0.3760	0.3834	0.3866		
	F	0.3845	0.3913	0.3922	0.3855	0.3880	0.3832	0.3834	0.3866		
	G	0.3922	0.3855	0.3791	0.3679	0.3802	0.3726	0.3880	0.3832		
	H	0.3802	0.3726	0.3756	0.3760	0.3714	0.3737	0.3791	0.3679		
5000 K	E	0.3451	0.3648	0.3372	0.3528	0.3371	0.3496	0.3396	0.3514	0.3449	0.3609
	F	0.3451	0.3648	0.3530	0.3612	0.3496	0.3588	0.3449	0.3609		
	G	0.3530	0.3612	0.3441	0.3454	0.3443	0.3493	0.3496	0.3588		
	H	0.3443	0.3493	0.3396	0.3514	0.3371	0.3496	0.3369	0.3445	0.3441	0.3454
5700 K	E	0.3283	0.3502	0.3212	0.3373	0.3213	0.3365	0.3242	0.3388	0.3284	0.3471
	F	0.3283	0.3502	0.3363	0.3486	0.3332	0.3462	0.3284	0.3471		
	G	0.3363	0.3486	0.3291	0.3348	0.3290	0.3379	0.3332	0.3462		
	H	0.3291	0.3348	0.3215	0.3337	0.3213	0.3365	0.3242	0.3388	0.3290	0.3379

6500 K	E	0.3110	0.3340	0.3054	0.3220	0.3082	0.3245	0.3115	0.3317
	F	0.3110	0.3340	0.3192	0.3344	0.3165	0.3319	0.3115	0.3317
	G	0.3192	0.3344	0.3136	0.3224	0.3131	0.3247	0.3165	0.3319
	H	0.3136	0.3224	0.3054	0.3220	0.3082	0.3245	0.3131	0.3247

Group Name on Label

Example: G6-M1

Brightness

Forward Voltage

G6

M1

Relative Spectral Emission ⁶⁾

$\Phi_{rel} = f(\lambda); I_F = 60 \text{ mA}; T_J = 25 \text{ }^\circ\text{C}$

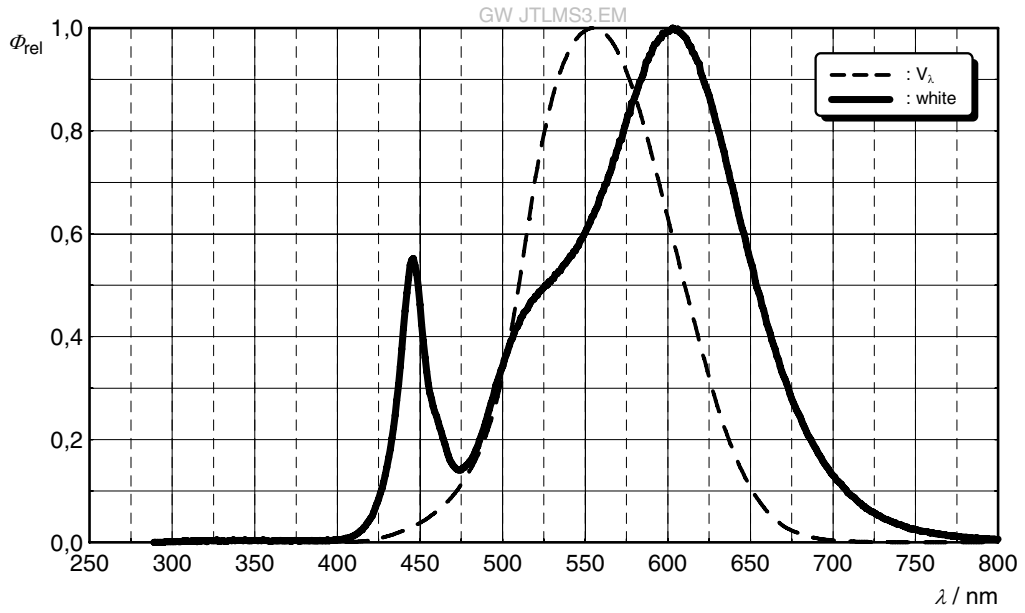

Radiation Characteristics ⁶⁾

$I_{rel} = f(\varphi); T_J = 25 \text{ }^\circ\text{C}$

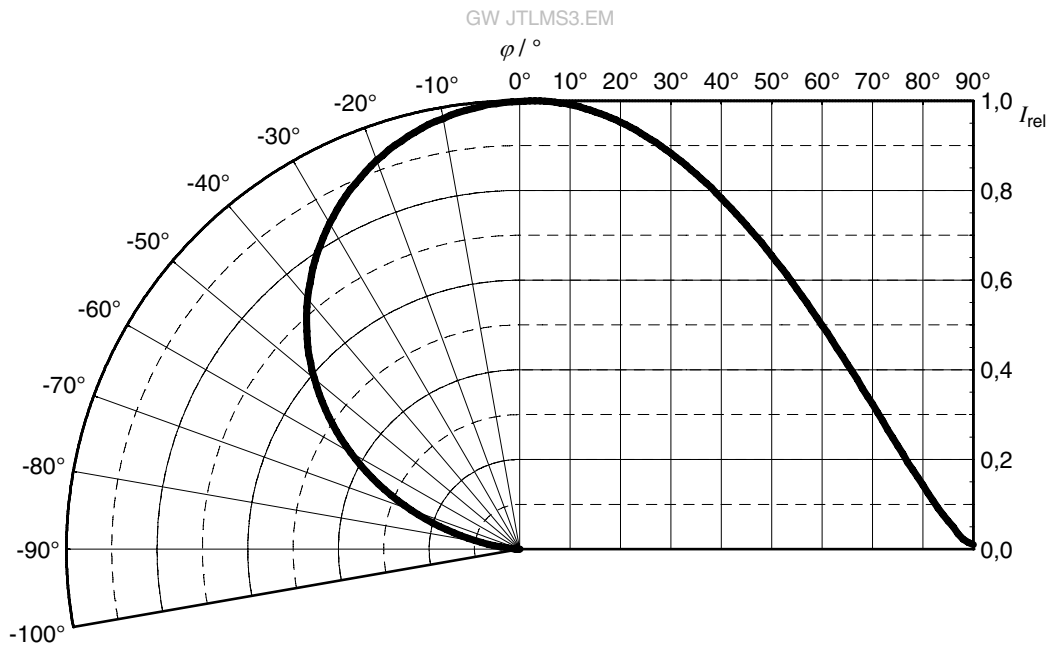

Forward current ⁶⁾

$$I_F = f(V_F); T_J = 25\text{ °C}$$

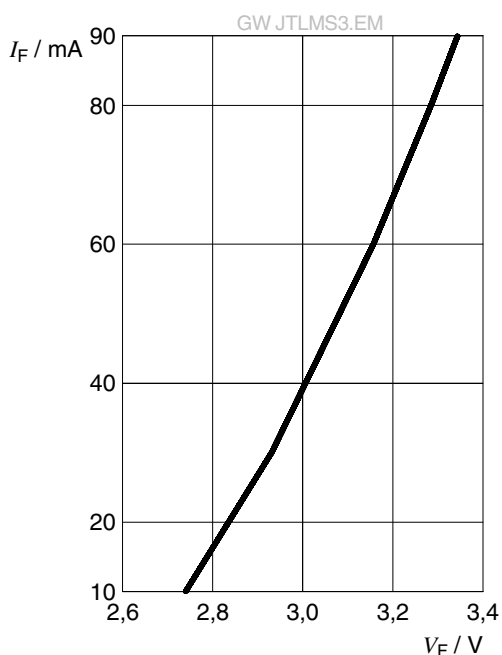

Relative Luminous Flux ^{6), 7)}

$$\Phi_V / \Phi_V(60\text{ mA}) = f(I_F); T_J = 25\text{ °C}$$

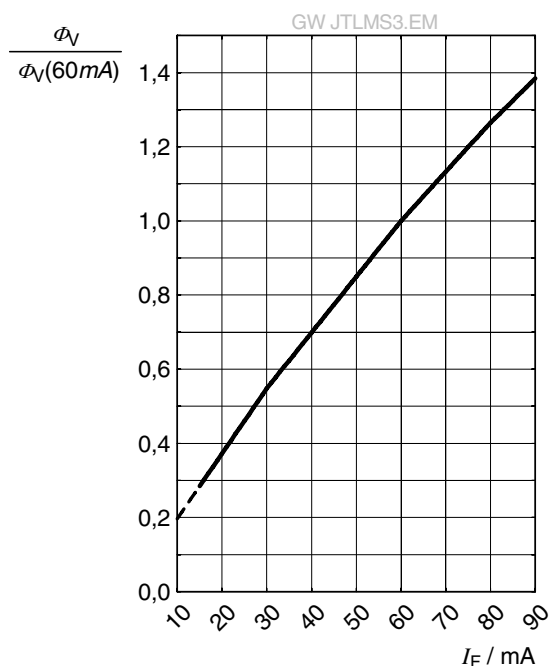

Chromaticity Coordinate Shift ⁶⁾

$$\Delta C_x, \Delta C_y = f(I_F); T_J = 25\text{ °C}$$

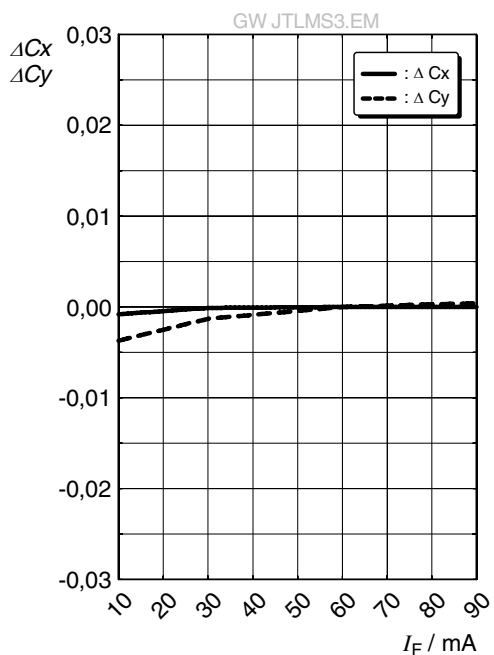

Forward Voltage ⁶⁾

$\Delta V_F = V_F - V_F(25\text{ }^\circ\text{C}) = f(T_j); I_F = 60\text{ mA}$

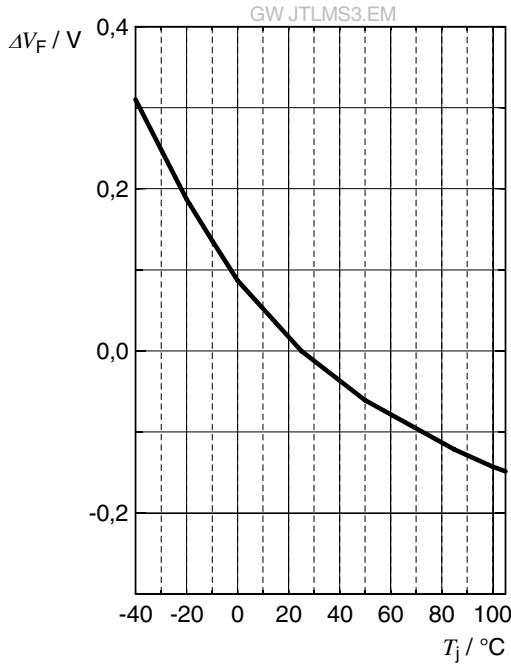

Relative Luminous Flux ⁶⁾

$\Phi_v / \Phi_v(25\text{ }^\circ\text{C}) = f(T_j); I_F = 60\text{ mA}$

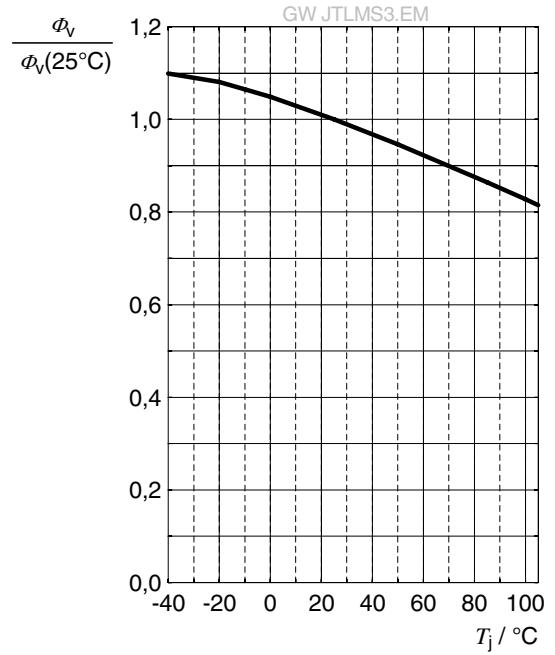

Chromaticity Coordinate Shift ⁶⁾

$\Delta C_x, \Delta C_y = f(T_j); I_F = 60\text{ mA}$

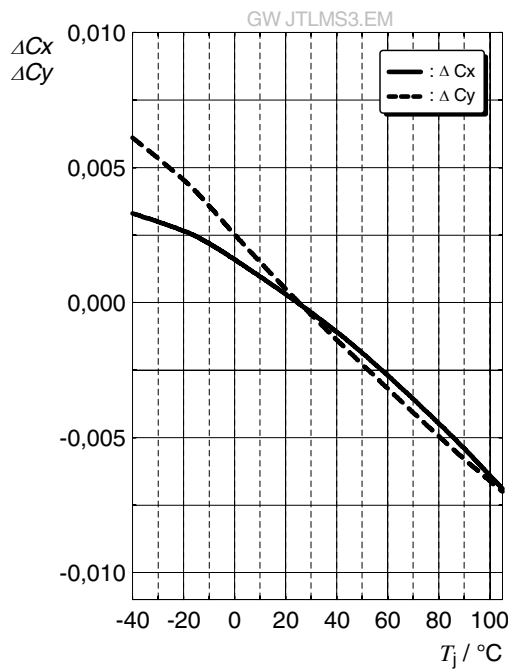

Max. Permissible Forward Current ⁸⁾

$$I_F = f(T)$$

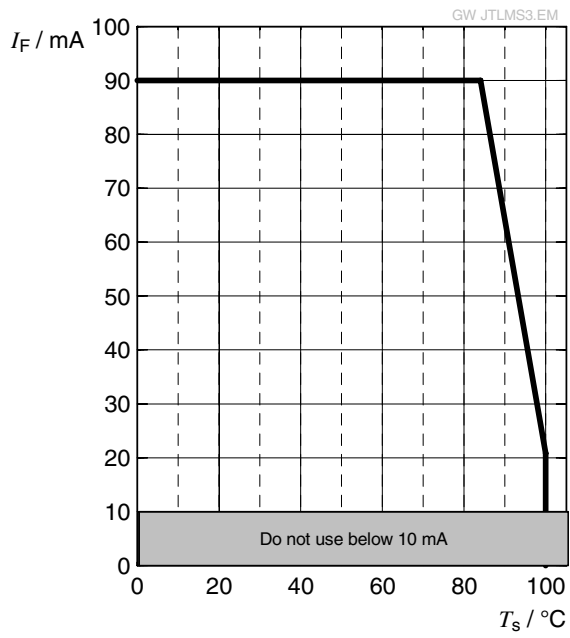

Dimensional Drawing ⁹⁾

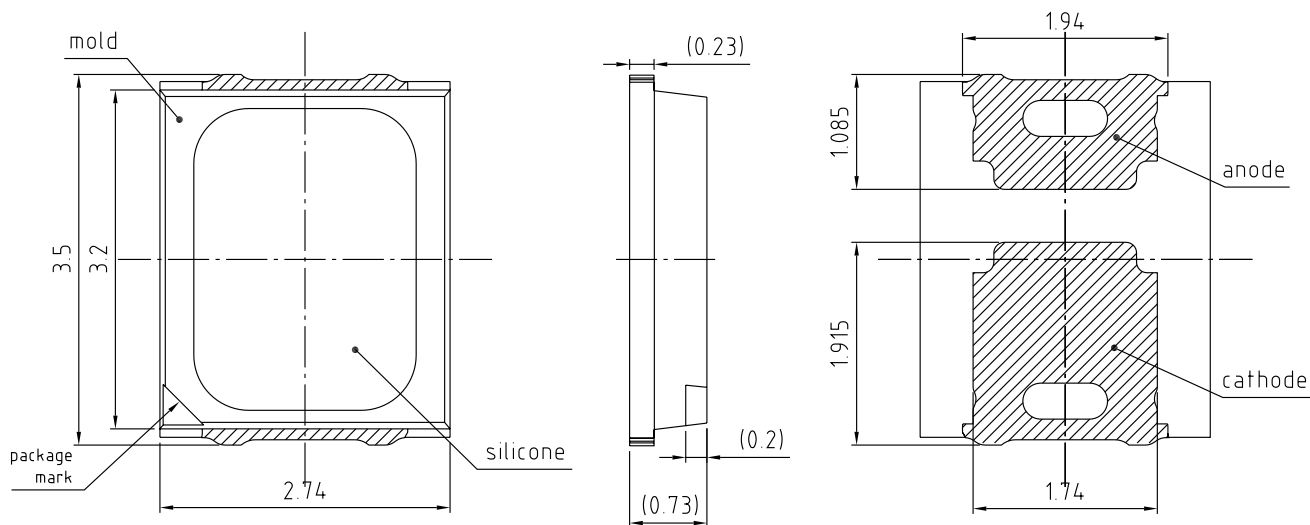

general tolerance ± 0.1

lead finish Ag 

C67062-A0472-A1-01

Further Information:

Approximate Weight: 18.0 mg

Package marking: Cathode

Recommended Solder Pad ⁹⁾

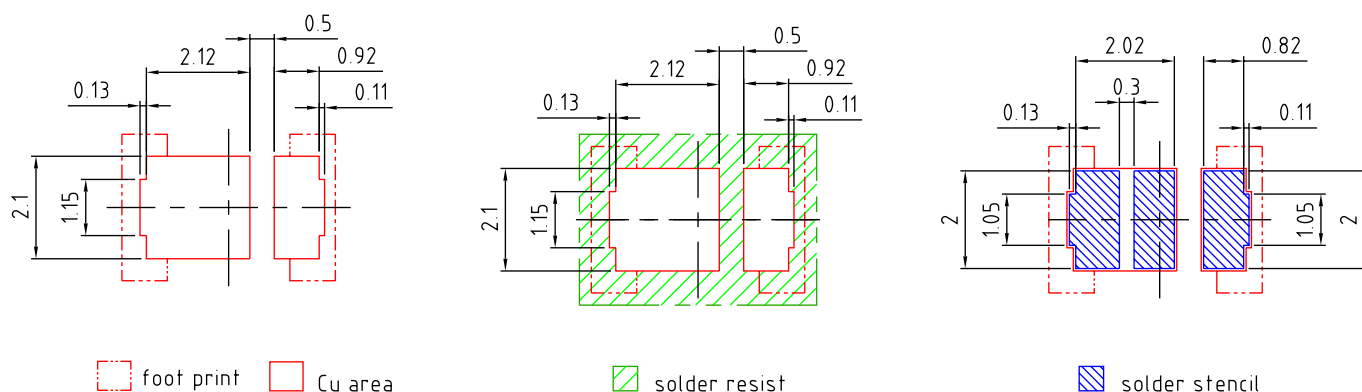

E067.0346.04-01

For superior solder joint connectivity results we recommend soldering under standard nitrogen atmosphere. Package not suitable for ultra sonic cleaning.

Reflow Soldering Profile

Product complies to MSL Level 3 acc. to JEDEC J-STD-020E

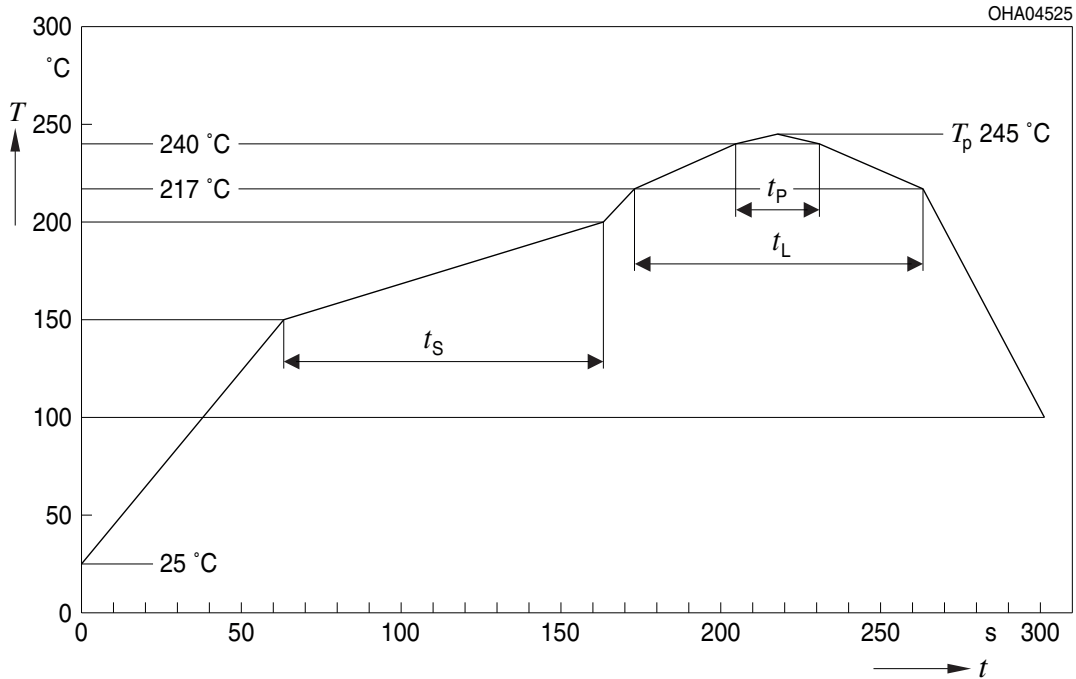

Profile Feature	Symbol	Pb-Free (SnAgCu) Assembly			Unit
		Minimum	Recommendation	Maximum	
Ramp-up rate to preheat ^{*)} 25 °C to 150 °C			2	3	K/s
Time t_s T_{Smin} to T_{Smax}	t_s	60	100	120	s
Ramp-up rate to peak ^{*)} T_{Smax} to T_p			2	3	K/s
Liquidus temperature	T_L		217		°C
Time above liquidus temperature	t_L		80	100	s
Peak temperature	T_p		245	260	°C
Time within 5 °C of the specified peak temperature $T_p - 5$ K	t_p	10	20	30	s
Ramp-down rate* T_p to 100 °C			3	6	K/s
Time 25 °C to T_p				480	s

All temperatures refer to the center of the package, measured on the top of the component
 *) slope calculation DT/Dt : Dt max. 5 s; fulfillment for the whole T-range

Taping ⁹⁾

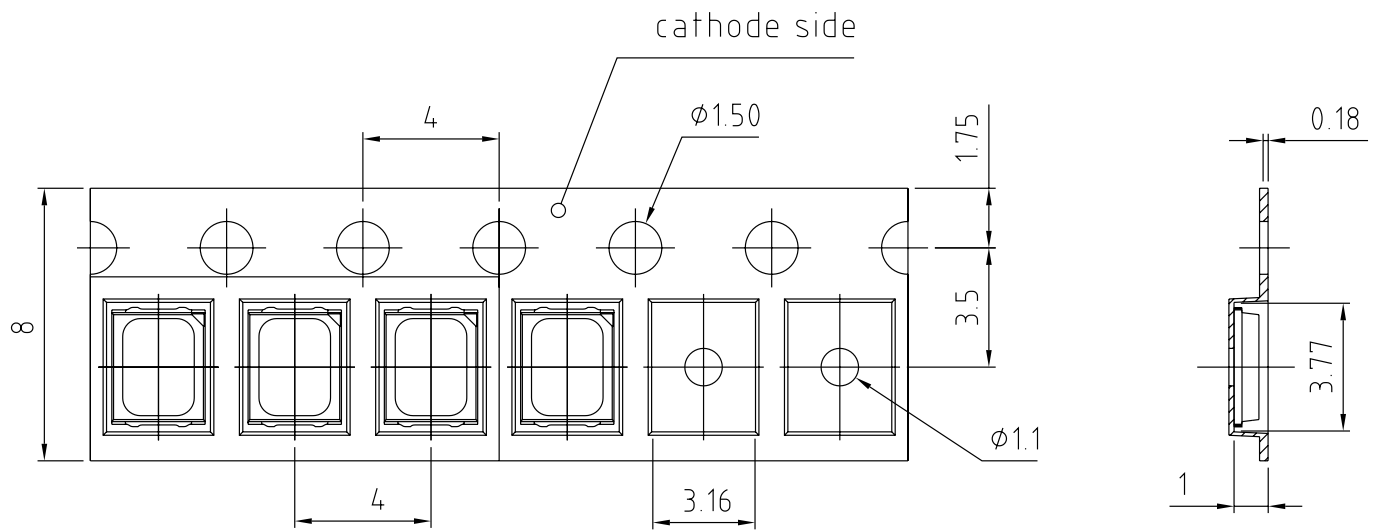

C67062-A0472-B1-01

Tape and Reel ¹⁰⁾

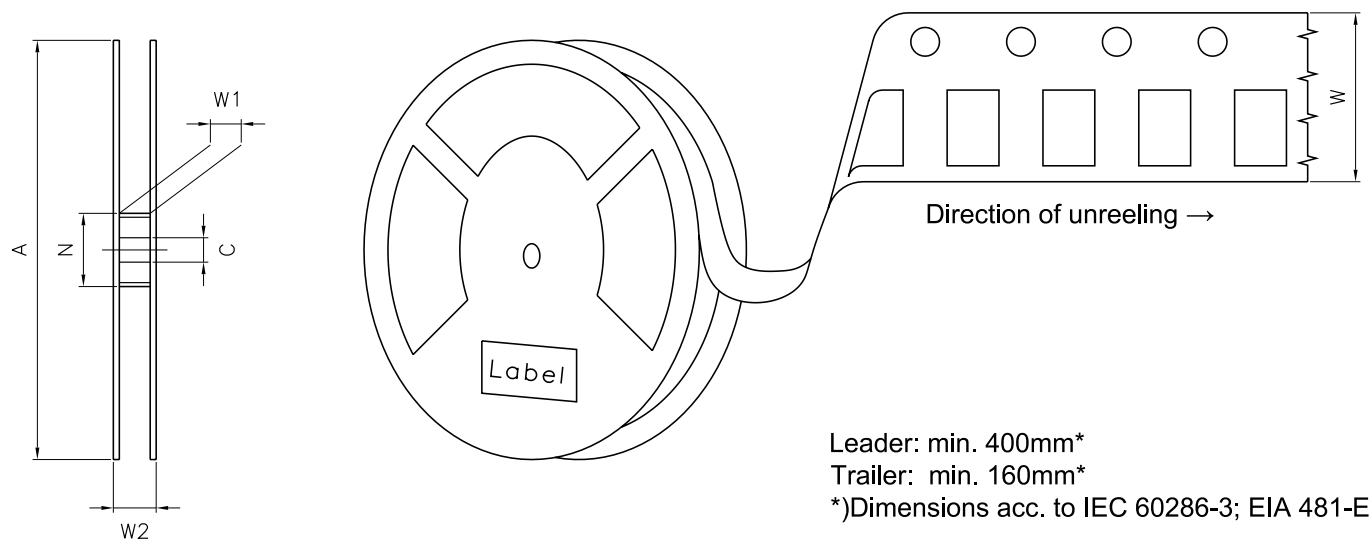

Reel Dimensions

A	W	N_{\min}	W_1	$W_{2\max}$	Pieces per PU
330 mm	$8 + 0.3 / - 0.1$ mm	60 mm	$8.4 + 2$ mm	14.4 mm	10000

Barcode-Product-Label (BPL)

OSRAM LX XXXX BIN1: XX-XX-X-XXX-X





RoHS Compliant

(6P) BATCH NO: 1234567890 ML Temp ST
X XXX °C X

(1T) LOT NO: 1234567890 (9D) D/C: 1234

Pack: RXX
DEMY XXX
X_X123_1234.1234 X

(X) PROD NO: 123456789(Q)QTY: 9999 (G) GROUP: XX-XX-X-X

OHA04563

Dry Packing Process and Materials ⁹⁾

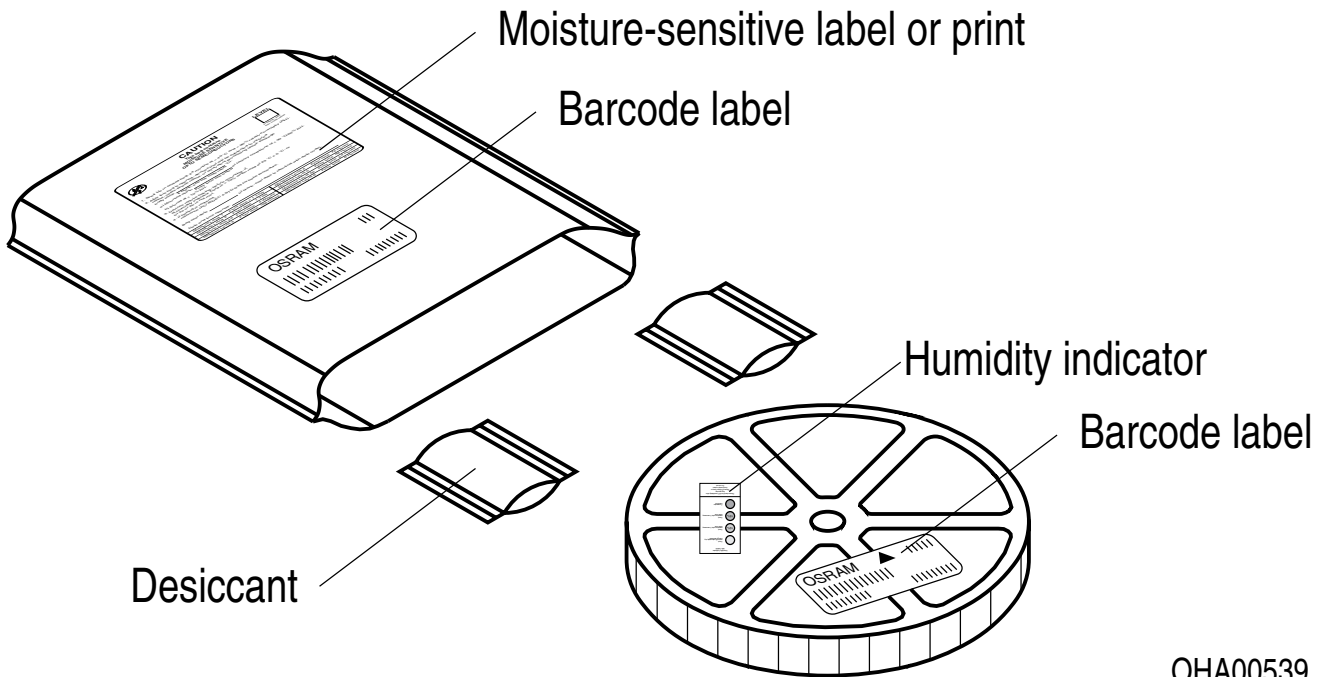

OHA00539

Moisture-sensitive product is packed in a dry bag containing desiccant and a humidity card according JEDEC-STD-033.

Notes

The evaluation of eye safety occurs according to the standard IEC 62471:2006 (photo biological safety of lamps and lamp systems). Within the risk grouping system of this IEC standard, the device specified in this data sheet fall into the class **low risk (exposure time 100 s)**. Under real circumstances (for exposure time, conditions of the eye pupils, observation distance), it is assumed that no endangerment to the eye exists from these devices. As a matter of principle, however, it should be mentioned that intense light sources have a high secondary exposure potential due to their blinding effect. When looking at bright light sources (e.g. headlights), temporary reduction in visual acuity and afterimages can occur, leading to irritation, annoyance, visual impairment, and even accidents, depending on the situation.

Subcomponents of this device contain, in addition to other substances, metal filled materials including silver. Metal filled materials can be affected by environments that contain traces of aggressive substances. Therefore, we recommend that customers minimize device exposure to aggressive substances during storage, production, and use. Devices that showed visible discoloration when tested using the described tests above did show no performance deviations within failure limits during the stated test duration. Respective failure limits are described in the IEC60810.

This device is designed for specific/recommended applications only. Please consult OSRAM Opto Semiconductors Sales Staff in advance for detailed information on other non-recommended applications (e.g. automotive).

Change management for this component is aligned with the requirements of the lighting market.

For further application related information please visit <https://ams-osram.com/support/application-notes>

Disclaimer

Attention please!

The information describes the type of component and shall not be considered as assured characteristics. Terms of delivery and rights to change design reserved. Due to technical requirements components may contain dangerous substances.

For information on the types in question please contact our Sales Organization.

If printed or downloaded, please find the latest version on our website.

Packing

Please use the recycling operators known to you. We can also help you – get in touch with your nearest sales office. By agreement we will take packing material back, if it is sorted. You must bear the costs of transport. For packing material that is returned to us unsorted or which we are not obliged to accept, we shall have to invoice you for any costs incurred.

Product and functional safety devices/applications or medical devices/applications

Our components are not developed, constructed or tested for the application as safety relevant component or for the application in medical devices.

Our products are not qualified at module and system level for such application.

In case buyer – or customer supplied by buyer – considers using our components in product safety devices/ applications or medical devices/applications, buyer and/or customer has to inform our local sales partner immediately and we and buyer and /or customer will analyze and coordinate the customer-specific request between us and buyer and/or customer.

Glossary

- 1) **Brightness:** Brightness values are measured during a current pulse of typically 10 ms, with a tolerance of +/- 7%.
- 2) **Reverse Operation:** Not designed for reverse operation. Continuous reverse operation can cause migration and damage of the device.
- 3) **Forward Voltage:** The Forward voltage is measured during a current pulse duration of typically 1 ms with a tolerance of $\pm 0.05V$.
- 4) **Color reproduction index:** Color reproduction index values (CRI-RA) are measured during a current pulse of typically 10 ms and with a tolerance of ± 2 . And CRI-R9 are measured during a current pulse of typically 10 ms and the 4000K with a tolerance of ± 6 .
- 5) **Chromaticity coordinate groups:** Chromaticity coordinate groups are measured during a current pulse duration of typically 10ms with a tolerance of ± 0.005 .
- 6) **Typical Values:** Due to the special conditions of the manufacturing processes of semiconductor devices, the typical data or calculated correlations of technical parameters can only reflect statistical figures. These do not necessarily correspond to the actual parameters of each single product, which could differ from the typical data and calculated correlations or the typical characteristic line. If requested, e.g. because of technical improvements, these typ. data will be changed without any further notice.
- 7) **Characteristic curve:** In the range where the line of the graph is broken, you must expect higher differences between single devices within one packing unit.
- 8) **Thermal Resistance:** $R_{th\ max}$ is based on statistic values (6σ) used for Derating.
- 9) **Tolerance of Measure:** Unless otherwise noted in drawing, tolerances are specified with ± 0.1 and dimensions are specified in mm.
- 10) **Tape and Reel:** All dimensions and tolerances are specified acc. IEC 60286-3 and specified in mm.

Revision History

Version	Date	Change
1.0	2023-09-21	Initial Version
1.1	2024-07-17	Description Ordering Information



EU RoHS and China RoHS compliant product

此产品符合欧盟 RoHS 指令的要求；
按照中国的相关法规和标准，
不含有毒有害物质或元素。

Published by ams-OSRAM AG

Tobelbader Strasse 30, 8141 Premstaetten, Austria

Phone +43 3136 500-0

ams-osram.com

© All rights reserved

am 

OSRAM

Mouser Electronics

Authorized Distributor

Click to View Pricing, Inventory, Delivery & Lifecycle Information:

[ams OSRAM:](#)

[GW JTLMS3.EM-G9H1-XX53-1-60-R33](#) [GW JTLMS3.EM-G6G9-XX510-1-60-R33](#) [GW JTLMS3.EM-G9H1-XX51-1-60-R33](#) [GW JTLMS3.EM-G8GW-XX58-1-60-R33](#) [GW JTLMS3.EM-G9H1-XX52-1-60-R33](#) [GW JTLMS3.EM-G9H1-XX55-1-60-R33](#) [GW JTLMS3.EM-G9H1-XX57-1-60-R33](#) [GW JTLMS3.EM-G9H1-XX56-1-60-R33](#) [GW JTLMS3.EM-G7G9-XX39-1-60-R33](#) [GW JTLMS3.EM-G6GV-XX59-1-60-R33](#) [GW JTLMS3.EM-G9GW-XX32-1-60-R33](#) [GW JTLMS3.EM-G9GW-XX36-1-60-R33](#) [GW JTLMS3.EM-G8GV-XX38-1-60-R33](#) [GW JTLMS3.EM-G9GW-XX31-1-60-R33](#) [GW JTLMS3.EM-G9GW-XX35-1-60-R33](#) [GW JTLMS3.EM-G6G8-XX310-1-60-R33](#) [GW JTLMS3.EM-G9GW-XX37-1-60-R33](#) [GW JTLMS3.EM-G9GW-XX33-1-60-R33](#)