

## RCIKIT 24VAC 2CO LD

**Weidmüller Interface GmbH & Co. KG**

Klingenbergstraße 26

D-32758 Detmold

Germany

www.weidmueller.com

### Product image

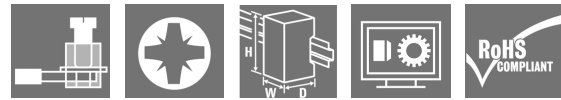

- Mounted kit consisting relay, socket and retaining clip
- 100 % function tested
- 100 % check of the dielectric strenght between input - output
- 2 CO contacts
- Optional test button with mechanical status indicator
- Bright status LED (AC coil: red / DC coil: green)
- Identification of coils (AC red / DC blue)

### General ordering data

Version	RIDERSERIES RCI, Relay module, Number of contacts: 2, CO contact AgNi, Rated control voltage: 24 V AC, Continuous current: 8 A, Screw connection, Test button available: No
Order No.	<a href="#">8871040000</a>
Type	RCIKIT 24VAC 2CO LD
GTIN (EAN)	4032248604197
Qty.	10 pc(s).
Relevant relay	<a href="#">8870210000</a>
Relevant base	<a href="#">8869490000</a>

Creation date January 30, 2022 9:51:45 AM CET

## RCIKIT 24VAC 2CO LD

**Weidmüller Interface GmbH & Co. KG**

Klingenbergstraße 26

D-32758 Detmold

Germany

www.weidmueller.com

## Technical data

### Dimensions and weights

Depth	70.2 mm	Depth (inches)	2.764 inch
Height	77 mm	Height (inches)	3.031 inch
Width	15.8 mm	Width (inches)	0.622 inch
Net weight	55.12 g		

### Temperatures

Storage temperature	-40 °C...70 °C	Operating temperature	-40 °C...70 °C
Humidity	40 °C / 93 % rel. humidity, no condensation		

### Environmental Product Compliance

REACH SVHC	Lead 7439-92-1
------------	----------------

### Control side

Rated control voltage	24 V AC	Rated current AC	45 mA
Power rating	1080 mVA	Pull-in/drop-out voltage, typ.	18 V / 3.6 V AC
Coil resistance	350 Ω ± 10 %	Status indicator	red LED

### Load side

Rated switching voltage	250 V AC	Continuous current	8 A
Max. switching frequency at rated load	0.1 Hz	Min. switching power	1 mA @ 24 V, 10 mA @ 12 V, 100 mA @ 5 V
Inrush current	15 A / 4 s	AC switching capacity (resistive), max.	2000 VA
DC switching capacity (resistive), max.	192 W @ 24 V	Switch-on delay	≤ 10 ms
Switch-off delay	≤ 6 ms	Contact type	2 CO contact (AgNi)
Mechanical service life	AC coil 5 x 10 <sup>6</sup> switching cycles, DC coil 10 x 10 <sup>6</sup> switching cycles		

### General data

Rail	TS 35	Test button available	No
Mechanical switch position indicator	No	Colour	black

### Insulation coordination

Rated voltage	250 V	Pollution severity	2
Surge voltage category	III	Insulating material group	IIIa
Clearance and creepage distances for control side - load side	≥ 8 mm	Dielectric strength for control side - load side	5 kV <sub>eff</sub> / 1 min
Dielectric strength of neighbouring contacts	2.5 kV <sub>eff</sub> / 1 Min.	Dielectric strength of open contact	1 kV <sub>eff</sub> / 1 min
Impulse withstand voltage	5 kV (1.2/50 μs)	Protection degree	IP20

### Further details of approvals / standards

Certificate no. (CSA) relay	249409-2426937	Certificate no. (CSA) base	249409-2295474
Certificate No. (DNVGL)	TAA000011A	Certificate no. (cURus) relay	E224238
Certificate no. (cURus) base	E223759		

## RCIKIT 24VAC 2CO LD

**Weidmüller Interface GmbH & Co. KG**

Klingenbergstraße 26

D-32758 Detmold

Germany

www.weidmueller.com

## Technical data

### Connection data

Wire connection method	Screw connection	Stripping length, rated connection	8 mm
Tightening torque, min.	0.5 Nm	Tightening torque, max.	0.7 Nm
Clamping range, rated connection	2.5 mm <sup>2</sup>	Clamping range, min.	1 mm <sup>2</sup>
Clamping range, max.	2.5 mm <sup>2</sup>	Wire cross-section, solid, min.	1 mm <sup>2</sup>
Wire cross-section, solid, max.	2.5 mm <sup>2</sup>	Wire connection cross section, finely stranded, min.	1 mm <sup>2</sup>
Wire connection cross section, finely stranded, max.	2.5 mm <sup>2</sup>	Wire connection cross-section, finely stranded with wire-end ferrules DIN 46228/4, min.	1 mm <sup>2</sup>
Wire connection cross-section, finely stranded with wire-end ferrules DIN 46228/4, max.	2.5 mm <sup>2</sup>	Conductor cross-section, flexible, AEH (DIN 46228-1), min.	1 mm <sup>2</sup>
Conductor cross-section, flexible, AEH (DIN 46228-1), max.	2.5 mm <sup>2</sup>	Wire connection cross section, finely stranded, two clampable wires, min.	1 mm <sup>2</sup>
Wire cross-section, finely stranded, two clampable wires, max.	1.5 mm <sup>2</sup>	Blade size	size PZ1

### Classifications

ETIM 6.0	EC001437	ETIM 7.0	EC001437
ETIM 8.0	EC001437	ECLASS 9.0	27-37-16-01
ECLASS 9.1	27-37-16-01	ECLASS 10.0	27-37-16-01
ECLASS 11.0	27-37-16-01		

### Important note

Product information IP20 without connected conductor at complete opened clamping yoke connection.

### Approvals

Approvals



ROHS Conform

### Downloads

Approval/Certificate/Document of Conformity	<a href="#">EU Konformitätserklärung / EU Declaration of Conformity</a>
Engineering Data	<a href="#">CAD data - STEP</a>
Engineering Data	<a href="#">EPLAN, WSCAD, Zuken E3.S</a>
Catalogues	<a href="#">Catalogues in PDF-format</a>
Brochures	

**RCIKIT 24VAC 2CO LD**

**Weidmüller Interface GmbH & Co. KG**  
 Klingenbergstraße 26  
 D-32758 Detmold  
 Germany

www.weidmueller.com

**Drawings**

**Wiring diagram**

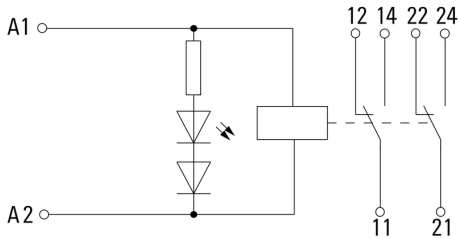

**Graph**

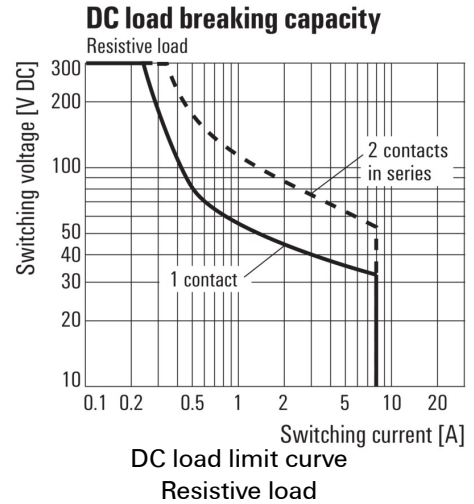

**Graph**

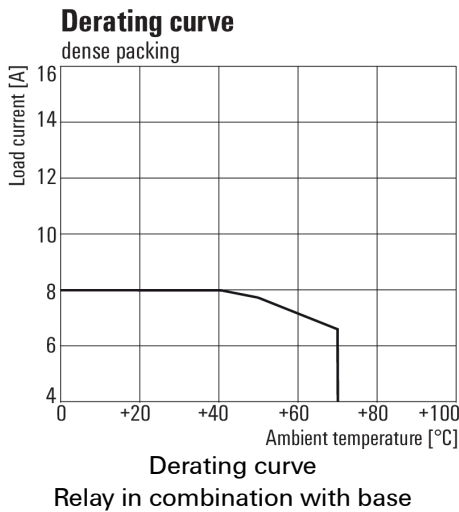

**Graph**

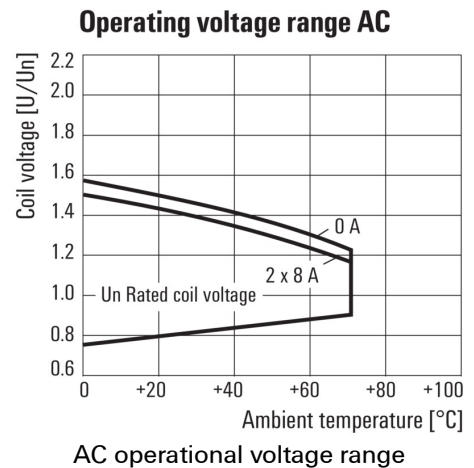

**Graph**

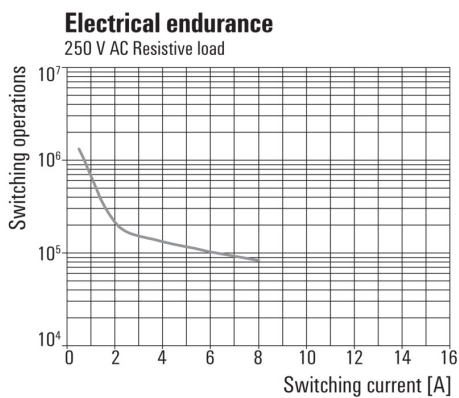

**Dimensioned drawing**

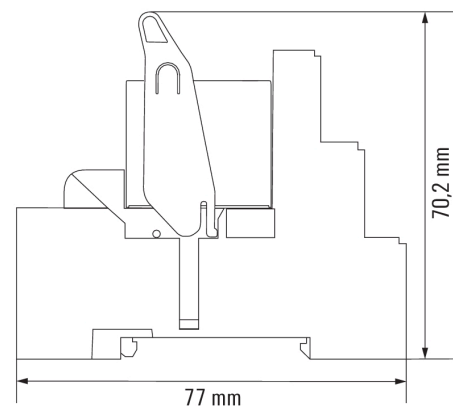

**RCIKIT 24VAC 2CO LD**

**Weidmüller Interface GmbH & Co. KG**  
 Klingenbergstraße 26  
 D-32758 Detmold  
 Germany

[www.weidmueller.com](http://www.weidmueller.com)

**Accessories****Cross-connection for socket with screw connection**

Cross-connection for the sockets in the D-SERIES DRI.

**General ordering data**

Type	SRC-I QV S	Version
Order No.	<a href="#">1132070000</a>	RIDERSERIES RCI, Cross-connector
GTIN (EAN)	4032248912087	
Qty.	10 pc(s).	

**Crosshead screwdriver Pozidriv**

VDE insulated crosshead screwdriver type Pozidriv SDIK PZ DIN 7438, ISO 8764/2-PZ, output to ISO 8764-PZ, SoftFinish grip

**General ordering data**

Type	SDIK PZ1 X 80	Version
Order No.	<a href="#">2749920000</a>	Screwdriver, Blade length: 80 mm
GTIN (EAN)	4050118897227	
Qty.	1 pc(s).	

## RCIKIT 24VAC 2CO LD

**Weidmüller Interface GmbH & Co. KG**  
Klingenbergstraße 26  
D-32758 Detmold  
Germany

www.weidmueller.com

## Accessories

## Protection module



Pluggable protective modules for the RIDERSERIES RCI / RCM relay sockets, with optional protective functions.

- Optional with free-wheeling diode, protective varistor, load resistor or RC filter

## General ordering data

Type	RIM-I 3 6/60VAC RC	Version
Order No.	<a href="#">8869770000</a>	RIDERSERIES, RC filter, Rated control voltage: 6...60 V UC, Plug-in connection
GTIN (EAN)	4032248606320	
Qty.	10 pc(s).	
Type	RIM-I 1 6/230V	Version
Order No.	<a href="#">8869580000</a>	RIDERSERIES, Free-wheeling diode, Rated control voltage: 6...230 V DC, Plug-in connection
GTIN (EAN)	4032248614523	
Qty.	10 pc(s).	

## LED



Pluggable protective modules for the RIDERSERIES RCI / RCM relay sockets, with optional protective functions.

- Optional with green or red LED
- For UC supply voltage

## General ordering data

Type	RIM-I 3 24/60VUC	Version
Order No.	<a href="#">8869610000</a>	RIDERSERIES, LED module, Rated control voltage: 24...60 V UC, Plug-in connection
GTIN (EAN)	4032248614554	
Qty.	10 pc(s).	
Type	RIM-I 3 6/24VUC	Version
Order No.	<a href="#">8869630000</a>	RIDERSERIES, LED module, Rated control voltage: 6...24 V UC, Plug-in connection
GTIN (EAN)	4032248614578	
Qty.	10 pc(s).	
Type	RIM-I 3 6/24VUC GN	Version
Order No.	<a href="#">8869640000</a>	RIDERSERIES, LED module, Rated control voltage: 6...24 V UC, Plug-in connection
GTIN (EAN)	4032248614585	
Qty.	10 pc(s).	
Type	RIM-I 3 24/60VUC GN	Version
Order No.	<a href="#">8869620000</a>	RIDERSERIES, LED module, Rated control voltage: 24...60 V UC, Plug-in connection
GTIN (EAN)	4032248614561	
Qty.	10 pc(s).	

**RCIKIT 24VAC 2CO LD**

**Weidmüller Interface GmbH & Co. KG**  
 Klingenbergstraße 26  
 D-32758 Detmold  
 Germany

www.weidmueller.com

**Accessories**

**Crosshead screwdriver, Pozidrive**



VDE insulated screwdriver sets, for working on live parts up to 1000 V AC and 1500 V DC, DIN EN 60900. IEC 900. Each piece is "GS" safety tested. Blade made from fully hardened, high-alloy chromium-vanadium-molybdenum steel, gun-metal finish.

**General ordering data**

Type	SDIK SLIM PZ1 X 80	Version
Order No.	<a href="#">2749670000</a>	Mounting tool, Blade length: 80 mm
GTIN (EAN)	4050118896411	
Qty.	1 pc(s).	

**ESG 6/17**



**Guaranteed long service life: ESG**

The multi-colour and multi-format labels have a strong adhesive layer to ensure the best possible adhesion to the underlying surface. Double laminated polyester makes the basic material very thin and yet extremely tear-resistant.

**Your benefits with MultiMark**

- "Different materials for various requirements"
- Can be used with equipment from many manufacturers
- Device markers with a familiar design

**General ordering data**

Type	ESG 6/17 MM WS	Version
Order No.	<a href="#">2005100000</a>	ESG, Device markers, 6 x 17 mm, white
GTIN (EAN)	4050118390728	
Qty.	3,000 pc(s).	

## RCIKIT 24VAC 2CO LD

**Weidmüller Interface GmbH & Co. KG**  
 Klingenbergstraße 26  
 D-32758 Detmold  
 Germany

www.weidmueller.com

## Accessories

### Protective varistor



Pluggable protective modules for the RIDERSERIES RCI / RCM relay sockets, with optional protective functions.

- With protective varistor
- For UC supply voltage

### General ordering data

Type	RIM-I 4 24VUC VAR	Version
Order No.	<a href="#">8869710000</a>	RIDERSERIES, Protective varistor, Rated control voltage: 24 V UC, Plug-
GTIN (EAN)	4032248606344	in connection
Qty.	10 pc(s).	

### Blank



ESG is the tried-and-tested marker in MultiCard format for use on many well-known electrical devices. The result is high-quality device marking with a high-contrast appearance.

Various types are available for devices from manufacturers like Siemens, ABB, Beckhoff etc.

Advantages at a glance:

- Tags for universal usage, self-adhesive or clip-on tags, depending on type
- For aligned equipment, e.g. circuit breakers, we supply ESG markers for clipping onto tag rails
- Individual laser-quality printing according to specifications

**For custom printing:** Please send us a file of our labeling software M-Print PRO or M-Print PRO Online (without installation) for your labeling specifications.

### General ordering data

Type	ESG 6/15 K MC NE WS	Version
Order No.	<a href="#">1880100000</a>	ESG, Device markers x 15 mm, PA 66, Colour: white, Self-adhesive
GTIN (EAN)	4032248478781	
Qty.	200 pc(s).	
Type	ESG 6/15 K MC NE GE	Version
Order No.	<a href="#">1880130000</a>	ESG, Device markers x 15 mm, PA 66, Colour: yellow, Self-adhesive
GTIN (EAN)	4032248478910	
Qty.	200 pc(s).	
Type	ESG 6/15 SRC-I MC NE WS	Version
Order No.	<a href="#">2558350000</a>	ESG, Device markers x 15 mm, PA 66, Colour: white
GTIN (EAN)	4050118569063	
Qty.	200 pc(s).	



**RCIKIT 24VAC 2CO LD**

**Weidmüller Interface GmbH & Co. KG**  
 Klingenbergstraße 26  
 D-32758 Detmold  
 Germany

[www.weidmueller.com](http://www.weidmueller.com)

**Accessories****Crosshead screwdriver Pozidriv**

Crosshead screwdriver, Pozidriv, SDK PZ DIN 5262, ISO 8764/2-PZ, output to ISO 8764/1-PZ, ChromTop tip, SoftFinish grip

**General ordering data**

Type	SDK PZ1 X 80	Version
Order No.	<a href="#">2749440000</a>	Screwdriver, Blade length: 80 mm
GTIN (EAN)	4050118895667	
Qty.	1 pc(s).	

**ESG 6/15****Guaranteed long service life: ESG**

The multi-colour and multi-format labels have a strong adhesive layer to ensure the best possible adhesion to the underlying surface. Double laminated polyester makes the basic material very thin and yet extremely tear-resistant.

**Your benefits with MultiMark**

- "Different materials for various requirements"
- Can be used with equipment from many manufacturers
- Device markers with a familiar design

**General ordering data**

Type	ESG 6/15 MM WS	Version
Order No.	<a href="#">2619940000</a>	ESG, Device markers, 6 x 15 mm, white
GTIN (EAN)	4050118626148	
Qty.	3,000 pc(s).	

## RCIKIT 24VAC 2CO LD

**Weidmüller Interface GmbH & Co. KG**  
 Klingenbergstraße 26  
 D-32758 Detmold  
 Germany

www.weidmueller.com

# Accessories

## Retaining clips



Retaining clip for RIDERSERIES RCI relays  
 • Metal and plastic retaining clip

## General ordering data

Type	SRC-I CLIP HM RCI	Version
Order No.	<a href="#">1132090000</a>	RIDERSERIES RCI, Retaining clip
GTIN (EAN)	4032248912209	
Qty.	20 pc(s).	
Type	SRC-I CLIP HP	Version
Order No.	<a href="#">8869510000</a>	RIDERSERIES RCI, Retaining clip
GTIN (EAN)	4032248614462	
Qty.	10 pc(s).	

**Data sheet**

**RCIKIT 24VAC 2CO LD**

**Weidmüller Interface GmbH & Co. KG**  
 Klingenbergstraße 26  
 D-32758 Detmold  
 Germany

www.weidmueller.com

**Drawings**

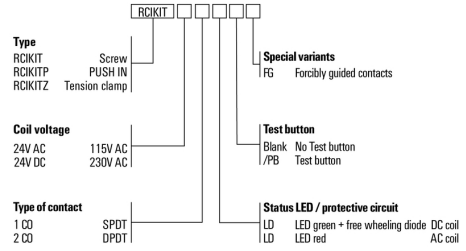

# Mouser Electronics

Authorized Distributor

Click to View Pricing, Inventory, Delivery & Lifecycle Information:

[Weidmuller:](#)

[8871040000](#)