

MCZ O 24VDC

Weidmüller Interface GmbH & Co. KG

Klingenbergstraße 26

D-32758 Detmold

Germany

www.weidmueller.com

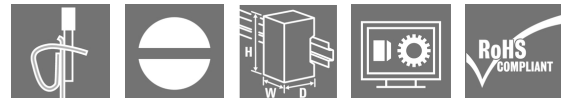
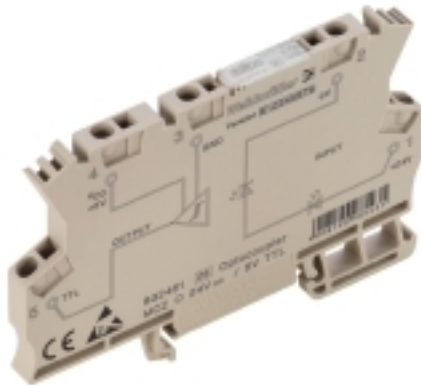

High reliability in a terminal block format
MCZ SERIES relay modules are among the smallest on the market. Thanks to the small width of just 6.1 mm, a lot of space can be saved in the panel. All products in the series have three cross-connection terminals and are distinguished by simple wiring with plug-in cross-connections. The tension clamp connection system, proven a million times over, and the integrated reverse polarity protection ensure a high level of safety during installation and operation. Precisely fitting accessories from cross-connectors to markers and end plates make the MCZ SERIES versatile and convenient to use.

- Tension clamp connection
- Integrated cross-connection in input/output.
- Clampable conductor cross-section is 0.5 to 1.5 mm²
- Variants of the MCZ TRAK type are particularly suitable for the transport sector and tested according to DIN EN 50155

General ordering data

Version	MCZ SERIES, Solid-state relay, Rated control voltage: 24 V DC $\pm 16\%$, Rated switching voltage: 5 V TTL, Continuous current: 8 ma, Fan out = 20 LS-TTL, Tension-clamp connection
Order No.	8324610000
Type	MCZ O 24VDC
GTIN (EAN)	400819098543 1
Qty.	10 pc(s).

MCZ O 24VDC

Weidmüller Interface GmbH & Co. KG

Klingenbergstraße 26

D-32758 Detmold

Germany

www.weidmueller.com

Technical data

Dimensions and weights

Depth	63.2 mm	Depth (inches)	2.488 inch
Height	91 mm	Height (inches)	3.583 inch
Width	6.1 mm	Width (inches)	0.24 inch
Net weight	23.9 g		

Temperatures

Storage temperature	-40 °C...60 °C	Operating temperature	-25 °C...40 °C
Humidity	40 °C / 93 % rel. humidity, no condensation		

Probability of failure

MTTF	3,036 Years
------	-------------

Environmental Product Compliance

REACH SVHC	Lead 7439-92-1
------------	----------------

Rated data UL

Certificate No. (cURus)	E141197
-------------------------	---------

Control side

Rated control voltage	24 V DC \pm 16 %	Nominal control current	5 mA DC (\pm 20 %)
Power rating	112 mW	Pull-in/drop-out voltage, typ.	16.8 V / 16.5 V DC
Status indicator	Green LED	Protective circuit	Reverse polarity protection

Load side

Rated switching voltage	5 V TTL	Continuous current	0.008 A @ Fan out = 20 LS-TTL
Switch-on delay	\leq 1 μ s (at 20V DC)	Switch-off delay	\leq 2.5 μ s (at 28V DC)
max. switching frequency (DC control voltage)	100 kHz	Nominal auxiliary voltage	5 V DC \pm 5 %
Protective circuit, load side	Diode circuit	Short-circuit-proof	No
Contact type	1 NO contact (TTL)		

General data

Rail	TS 35				
Test button available	No				
Colour	beige				
UL94 flammability rating component	<table border="1"> <tr> <td>Component</td> <td>Housing</td> </tr> <tr> <td>UL94 flammability rating</td> <td>V-0</td> </tr> </table>	Component	Housing	UL94 flammability rating	V-0
Component	Housing				
UL94 flammability rating	V-0				

Insulation coordination

Rated voltage	300 V	Pollution severity	2
Surge voltage category	III	Clearance and creepage distances for control side - load side	\geq 5.5 mm
Dielectric strength for control side - load side	1 kV _{eff} / 1 s	Dielectric strength to mounting rail	4 kV _{eff} / 1 Min.
Impulse withstand voltage	6 kV (1.2/50 μ s)	Protection degree	IP20

Creation date January 30, 2022 7:42:47 AM CET

MCZ O 24VDC

Weidmüller Interface GmbH & Co. KG

Klingenbergstraße 26

D-32758 Detmold

Germany

www.weidmueller.com

Technical data

Further details of approvals / standards

Standards	DIN EN 50178, UL508	Certificate No. (CSA)	154685-1198742
Certificate No. (cURus)	E141197		

Connection data

Wire connection method	Tension-clamp connection	Stripping length, rated connection	8 mm
Clamping range, rated connection	1.5 mm ²	Clamping range, min.	0.5 mm ²
Clamping range, max.	1.5 mm ²	Wire connection cross section AWG, min.	AWG 26
Wire connection cross section AWG, max.	AWG 16	Wire cross-section, solid, min.	0.5 mm ²
Wire cross-section, solid, max.	1.5 mm ²	Wire cross-section, solid, min. (AWG)	AWG 26
Wire cross-section, solid, max. (AWG)	AWG 16	Wire connection cross section, finely stranded, min.	0.5 mm ²
Wire connection cross section, finely stranded, max.	1.5 mm ²	Wire cross-section, finely stranded, min. (AWG)	AWG 26
Wire cross-section, finely stranded, max. (AWG)	AWG 16	Wire connection cross-section, finely stranded with wire-end ferrules DIN 46228/4, min.	0.5 mm ²
Wire connection cross-section, finely stranded with wire-end ferrules DIN 46228/4, max.	1.5 mm ²	Conductor cross-section, flexible, AEH (DIN 46228-1), min.	0.5 mm ²
Conductor cross-section, flexible, AEH (DIN 46228-1), max.	1.5 mm ²	Blade size	0.6 x 3.5 mm

Classifications

ETIM 6.0	EC001504	ETIM 7.0	EC001504
ETIM 8.0	EC001504	ECLASS 9.0	27-37-16-04
ECLASS 9.1	27-37-16-04	ECLASS 10.0	27-37-16-04
ECLASS 11.0	27-37-16-04		

Important note

Product information The cable lengths must not exceed 30 m.

Approvals

Approvals



ROHS	Conform
UL File Number Search	E141197

Downloads

Approval/Certificate/Document of Conformity	EU Konformitätserklärung / EU Declaration of Conformity
Engineering Data	CAD data – STEP
Engineering Data	EPLAN, WSCAD
User Documentation	Beipackzettel / Package Insert – multilingual
Catalogues	Catalogues in PDF-format
Brochures	

Creation date January 30, 2022 7:42:47 AM CET

Catalogue status 14.01.2022 / We reserve the right to make technical changes.

Data sheet

MCZ O 24VDC

Weidmüller Interface GmbH & Co. KG
 Klingenbergstraße 26
 D-32758 Detmold
 Germany

www.weidmueller.com

Drawings

Wiring diagram

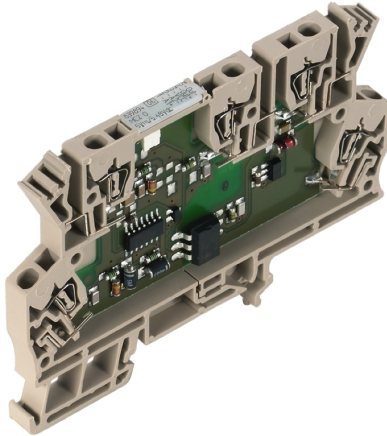

Similar to illustration

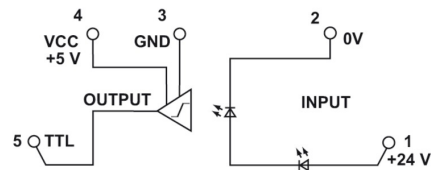

Schaltsymbol

Dimensional drawing

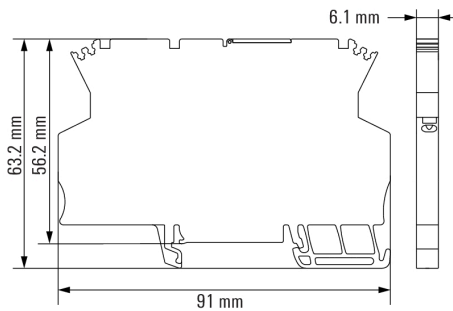

MCZ O 24VDC

Weidmüller Interface GmbH & Co. KG
 Klingenbergstraße 26
 D-32758 Detmold
 Germany

www.weidmueller.com

Accessories

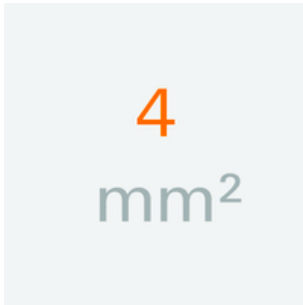
4 mm²

The plug-in cross-connections feature easy handling and quick installation. This saves a great deal of time during installation in comparison with screwed solutions.

General ordering data

Type	ZQV 4N/4
Order No.	1527970000
GTIN (EAN)	4050118332889
Qty.	60 pc(s).
Type	ZQV 4N/4 RD
Order No.	2460800000
GTIN (EAN)	4050118476224
Qty.	60 pc(s).
Type	ZQV 4N/3 BL
Order No.	1528080000
GTIN (EAN)	4050118333008
Qty.	60 pc(s).
Type	ZQV 4N/10
Order No.	1528090000
GTIN (EAN)	4050118332896
Qty.	20 pc(s).
Type	ZQV 4N/10 BL
Order No.	1528230000
GTIN (EAN)	4050118333138
Qty.	20 pc(s).
Type	ZQV 4N/4 BL
Order No.	1528120000
GTIN (EAN)	4050118332872
Qty.	60 pc(s).
Type	ZQV 4N/3 RD
Order No.	2460810000
GTIN (EAN)	4050118476231
Qty.	60 pc(s).
Type	ZQV 4N/2
Order No.	1527930000
GTIN (EAN)	4050118332766
Qty.	60 pc(s).
Type	ZQV 4N/2 BL
Order No.	1528040000
GTIN (EAN)	4050118332773
Qty.	60 pc(s).
Type	ZQV 4N/3
Order No.	1527940000
GTIN (EAN)	4050118332865
Qty.	60 pc(s).

Creation date January 30, 2022 7:42:47 AM CET

MCZ O 24VDC

Weidmüller Interface GmbH & Co. KG
 Klingenbergstraße 26
 D-32758 Detmold
 Germany

www.weidmueller.com

Accessories

Type ZQV 4N/2 RD
 Order No. [2460450000](#)
 GTIN (EAN) 4050118476149
 Qty. 60 pc(s).

Type ZQV 4N/10 RD
 Order No. [2460740000](#)
 GTIN (EAN) 4050118476163
 Qty. 20 pc(s).

AP MCZ 1.5 - End plate



Open miniature housing in modular terminal format with five tension clamp connections. A transparent hinged top plate can be used for labelling and provides access to potentiometer and status displays. Plug-in cross-connectors can be used to interconnect the three top connections. A cover plate for closing off the housing is also available.

General ordering data

Type	AP MCZ1.5 1674	Version	
Order No.	8389030000	Small housing, OMNIMATE Housing - TERMINALBOX grey-beige, End plate, Width: 1.5 mm	
GTIN (EAN)	4008190386849		
Qty.	50 pc(s).		

Slotted screwdriver

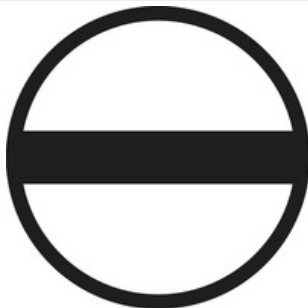

Slotted screwdriver with rounded blade SD DIN 5265, ISO 2380/2, output to DIN 5264, ISO 2380/1. ChromTop tip, SoftFinish grip

General ordering data

Type	SDS 0.6X3.5X100	Version	
Order No.	2749340000	Screwdriver, Blade width (B): 3.5 mm, Blade length: 100 mm, Blade thickness (A): 0.6 mm	
GTIN (EAN)	4050118895568		
Qty.	1 pc(s).		

MCZ O 24VDC

Weidmüller Interface GmbH & Co. KG
 Klingenbergstraße 26
 D-32758 Detmold
 Germany

www.weidmueller.com

Accessories

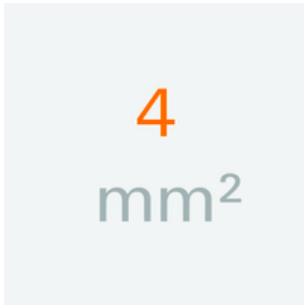
4 mm²

The plug-in cross-connections feature easy handling and quick installation. This saves a great deal of time during installation in comparison with screwed solutions.

General ordering data

Type	ZQV 4N/20 RT	Version
Order No.	1909150000	Accessories, Cross-connector, 32 A
GTIN (EAN)	4032248535934	
Qty.	20 pc(s).	
Type	ZQV 4N/3 SW	Version
Order No.	1794000000	Accessories, Cross-connector, 32 A
GTIN (EAN)	4032248233793	
Qty.	60 pc(s).	
Type	ZQV 4N/10 SW	Version
Order No.	1794060000	Accessories, Cross-connector, 32 A
GTIN (EAN)	4032248234059	
Qty.	20 pc(s).	
Type	ZQV 4N/4 SW	Version
Order No.	1794030000	Accessories, Cross-connector, 32 A
GTIN (EAN)	4032248233915	
Qty.	60 pc(s).	
Type	ZQV 4N/20 GE	Version
Order No.	1909020000	Accessories, Cross-connector, 32 A
GTIN (EAN)	4032248535644	
Qty.	20 pc(s).	
Type	ZQV 4N/2 SW	Version
Order No.	1793970000	Accessories, Cross-connector, 32 A
GTIN (EAN)	4032248233762	
Qty.	60 pc(s).	
Type	ZQV 4N/20 BL	Version
Order No.	1909100000	Accessories, Cross-connector, 32 A
GTIN (EAN)	4032248535774	
Qty.	20 pc(s).	

MCZ O 24VDC

Weidmüller Interface GmbH & Co. KG
 Klingenbergstraße 26
 D-32758 Detmold
 Germany

www.weidmueller.com

Accessories

2.5 mm²

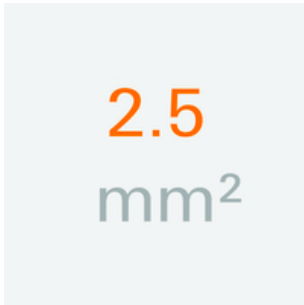

The plug-in cross-connections feature easy handling and quick installation. This saves a great deal of time during installation in comparison with screwed solutions.

General ordering data

Type	ZQV 2.5N/20 SW	Version
Order No.	1909130000	Z-series, Cross-connector, For the terminals, Number of poles: 20
GTIN (EAN)	40322485359 10	
Qty.	20 pc(s).	

Blank



WS markers are the perfect match for the W-series connectors. Thanks to their system compatibility, the WS tags can also be used with the I-series and the Z-series. The large marking surfaces do not only permit long character strings but also multi-line text. WS markers are ideal for labels with long, customised character strings. Thanks to the proven MultiCard format, printing with PrintJet CONNECT oder/or Plotter is possible.

- Can be fitted in strips or individually
- Markers in proven MultiCard format

For custom printing: Please send us a file of our labeling software M-Print PRO or M-Print PRO Online (without installation) for your labeling specifications.

General ordering data

Type	WS 10/6 MC NE WS	Version
Order No.	1828450000	WS, Terminal marker, 10 x 6 mm, Pitch in mm (P): 6.00 Weidmueller,
GTIN (EAN)	40322483505 13	Allen-Bradley, white
Qty.	600 pc(s).	

MCZ O 24VDC

Weidmüller Interface GmbH & Co. KG
 Klingenbergstraße 26
 D-32758 Detmold
 Germany

www.weidmueller.com

Accessories

Slotted screwdriver



VDE insulated screwdriver sets, for working on live parts up to 1000 V AC and 1500 V DC, DIN EN 60900. IEC 900. Each piece is "GS" safety tested. Blade made from fully hardened, high-alloy chromium-vanadium-molybdenum steel, gun-metal finish.

General ordering data

Type	SDIS SLIM 0.6X3.5X100	Version
Order No.	2749610000	Mounting tool, Blade width (B): 3.5 mm, Blade length: 100 mm, Blade
GTIN (EAN)	4050118896350	thickness (A): 0.6 mm
Qty.	1 pc(s).	

Slotted screwdriver



VDE insulated slot-head screwdriver, SDI DIN 7437, ISO 2380/2, drive output acc. to DIN 5264, ISO 2380/1. SoftFinish grip

General ordering data

Type	SDIS 0.6X3.5X100	Version
Order No.	2749810000	Screwdriver, Blade width (B): 3.5 mm, Blade length: 100 mm, Blade
GTIN (EAN)	4050118897012	thickness (A): 0.6 mm
Qty.	1 pc(s).	

Mouser Electronics

Authorized Distributor

Click to View Pricing, Inventory, Delivery & Lifecycle Information:

[Weidmuller:](#)

[8324610000](#)