

B2L 3.50/12/180LH SN OR BX

Weidmüller Interface GmbH & Co. KG

Klingenbergstraße 26

D-32758 Detmold

Germany

www.weidmueller.com

Product image

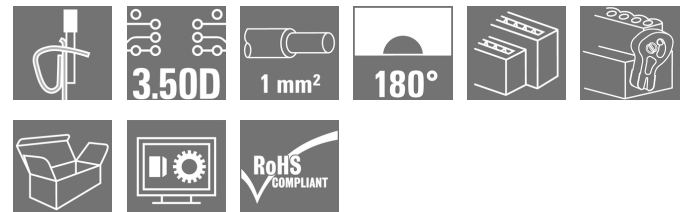
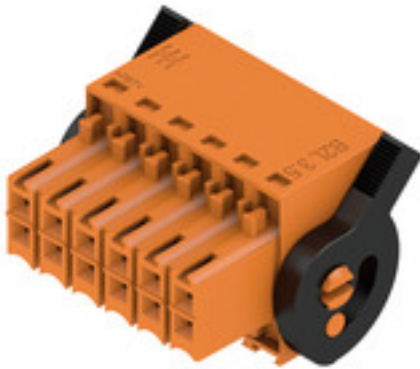

Female connectors with tension clamp connection system enable quick and simple wiring. These female header can be mounted side by side and therefore have a high connection density. The release lever simplifies the separation of the connection in confined spaces. The socket blocks provide space for labelling and can be coded.

General ordering data

Version	PCB plug-in connector, female plug, 3.50 mm, Number of poles: 12, 180°, Tension-clamp connection, Clamping range, max.: 1 mm ² , Box
Order No.	1748360000
Type	B2L 3.50/12/180LH SN OR BX
GTIN (EAN)	4032248038145
Qty.	66 pc(s).
Product data	IEC: 250 V / 10.3 A / 0.2 - 1 mm ² UL: 300 V / 10 A / AWG 28 - AWG 16
Packaging	Box

Creation date January 27, 2022 4:09:32 PM CET

B2L 3.50/12/180LH SN OR BX**Weidmüller Interface GmbH & Co. KG**

Klingenbergstraße 26

D-32758 Detmold

Germany

www.weidmueller.com

Technical data**Dimensions and weights**

Depth	20.6 mm	Depth (inches)	0.811 inch
Height	15.7 mm	Height (inches)	0.618 inch
Width	27.3 mm	Width (inches)	1.075 inch
Net weight	6.81 g		

System Parameters

Product family	OMNIMATE Signal - series B2L/S2L 3.50 - 2-row	Type of connection	Field connection
Wire connection method	Tension-clamp connection	Pitch in mm (P)	3.5 mm
Pitch in inches (P)	0.138 inch	Conductor outlet direction	180°
Number of poles	12	L1 in mm	17.5 mm
L1 in inches	0.689 inch	Number of rows	1
Pin series quantity	2	Rated cross-section	1 mm ²
Touch-safe protection acc. to DIN VDE 57 106	Safe from finger touch	Touch-safe protection acc. to DIN VDE 0470	IP 20
Can be coded	Yes	Stripping length	7 mm
Screwdriver blade	0.4 x 2.5	Screwdriver blade standard	DIN 5264
Plugging cycles	25	Plugging force/pole, max.	5 N
Pulling force/pole, max.	4 N		

Material data

Insulating material	PBT	Colour	orange
Colour chart (similar)	RAL 2000	UL 94 flammability rating	V-0
Contact material	Copper alloy	Contact surface	tinned
Storage temperature, min.	-40 °C	Storage temperature, max.	70 °C
Operating temperature, min.	-50 °C	Operating temperature, max.	100 °C
Temperature range, installation, min.	-30 °C	Temperature range, installation, max.	100 °C

Conductors suitable for connection

Clamping range, min.	0.08 mm ²
Clamping range, max.	1 mm ²
Wire connection cross section AWG, min.	AWG 28
Wire connection cross section AWG, max.	AWG 18
Solid, min. H05(07) V-U	0.2 mm ²
Solid, max. H05(07) V-U	1 mm ²
Flexible, min. H05(07) V-K	0.2 mm ²
Flexible, max. H05(07) V-K	1 mm ²
w. plastic collar ferrule, DIN 46228 pt 4, min.	0.14 mm ²
w. plastic collar ferrule, DIN 46228 pt 4, max.	0.34 mm ²
w. wire end ferrule, DIN 46228 pt 1, min.	0.14 mm ²
w. wire end ferrule, DIN 46228 pt 1, max.	0.34 mm ²

B2L 3.50/12/180LH SN OR BX
Weidmüller Interface GmbH & Co. KG

 Klingenbergstraße 26
 D-32758 Detmold
 Germany

www.weidmueller.com
Technical data

Clampable conductor	Cross-section for conductor connection	Type	fine-wired
	wire end ferrule	nominal	0.14 mm ²
		Stripping length	nominal 10 mm
		Recommended wire-end ferrule	HO.14/12 GR SV
	Cross-section for conductor connection	Type	fine-wired
	wire end ferrule	nominal	0.25 mm ²
		Stripping length	nominal 10 mm
		Recommended wire-end ferrule	HO.25/12 HBL

Reference text The outside diameter of the plastic collar should not be larger than the pitch (P). Length of ferrules is to be chosen depending on the product and the rated voltage.

Rated data acc. to IEC

tested acc. to standard	IEC 60664-1, IEC 61984	Rated current, min. number of poles (Tu=20°C)	10.3 A
Rated current, max. number of poles (Tu=20°C)	8.7 A	Rated current, min. number of poles (Tu=40°C)	8.9 A
Rated current, max. number of poles (Tu=40°C)	7.4 A	Rated voltage for surge voltage class / pollution degree II/2	250 V
Rated voltage for surge voltage class / pollution degree III/2	160 V	Rated voltage for surge voltage class / pollution degree III/3	80 V
Rated impulse voltage for surge voltage class/ pollution degree II/2	2.5 kV	Rated impulse voltage for surge voltage class/ pollution degree III/2	2.5 kV
Rated impulse voltage for surge voltage class/ contamination degree III/3	2.5 kV	Short-time withstand current resistance	3 x 1s with 77 A

Rated data acc. to CSA

Institute (CSA)		Certificate No. (CSA)	200039-1488444
Rated voltage (Use group B / CSA)	300 V	Rated current (Use group B / CSA)	5 A
Wire cross-section, AWG, min.	AWG 28	Wire cross-section, AWG, max.	AWG 18
Reference to approval values	Specifications are maximum values, details - see approval certificate.		

Rated data acc. to UL 1059

Institute (UR)		Certificate No. (UR)	E60693
Rated voltage (Use group B / UL 1059)	300 V	Rated voltage (Use group C / UL 1059)	50 V
Rated current (Use group B / UL 1059)	10 A	Rated current (Use group C / UL 1059)	10 A
Wire cross-section, AWG, min.	AWG 28	Wire cross-section, AWG, max.	AWG 16
Reference to approval values	Specifications are maximum values, details - see approval certificate.		

Packing

Packaging	Box	VPE length	348 mm
VPE width	135 mm	VPE height	31 mm

Creation date January 27, 2022 4:09:32 PM CET

Catalogue status 14.01.2022 / We reserve the right to make technical changes.

B2L 3.50/12/180LH SN OR BX

Weidmüller Interface GmbH & Co. KG
 Klingenbergstraße 26
 D-32758 Detmold
 Germany

www.weidmueller.com

Technical data**Classifications**

ETIM 6.0	EC002638	ETIM 7.0	EC002638
ETIM 8.0	EC002638	ECLASS 9.0	27-44-03-09
ECLASS 9.1	27-44-03-09	ECLASS 10.0	27-44-03-09
ECLASS 11.0	27-46-02-02		

Important note

IPC conformity	Conformity: The products are developed, manufactured and delivered according international recognized standards and norms and comply with the assured properties in the data sheet resp. fulfill decorative properties in accordance with IPC-A-610 "Class 2". Further claims on the products can be evaluated on request.
Notes	<ul style="list-style-type: none"> • Additional colours on request • Gold-plated contact surfaces on request • Rated current related to rated cross-section & min. No. of poles. • Wire end ferrule with plastic collar to DIN 46228/4 • Wire end ferrule without plastic collar to DIN 46228/1 • P on drawing = pitch • Crimp shape A for wire-end ferrules with crimping tools PZ 1,5 (order no. 9005990000) or PZ 6/5 (order no. 9011460000) for larger wire cross-sections recommended. • Rated data refer only to the component itself. Clearance and creepage distances to other components are to be designed in accordance with the relevant application standards.

Approvals

Approvals



ROHS	Conform
UL File Number Search	E60693

B2L 3.50/12/180LH SN OR BX

Weidmüller Interface GmbH & Co. KG
Klingenbergstraße 26
D-32758 Detmold
Germany

www.weidmueller.com

Technical data

Downloads

Approval/Certificate/Document of Conformity	Declaration of the Manufacturer
Engineering Data	CAD data – STEP
Engineering Data	EPLAN, WSCAD
Catalogues	Catalogues in PDF-format
Brochures	FL DRIVES EN MB DEVICE MANUF. EN FL DRIVES DE FL BUILDING SAFETY EN FL APPL LED LIGHTING EN FL INDUSTR.CONTROLS EN FL MACHINE SAFETY EN FL HEATING ELECTR EN FL APPL INVERTER EN FL_BASE_STATION_EN FL ELEVATOR EN FL POWER SUPPLY EN FL 72H SAMPLE SER EN PO OMNIMATE EN

B2L 3.50/12/180LH SN OR BX

Weidmüller Interface GmbH & Co. KG
 Klingenbergstraße 26
 D-32758 Detmold
 Germany

www.weidmueller.com

Drawings

Product image

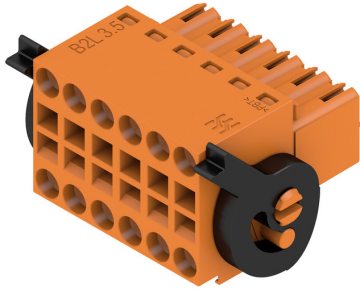

Dimensional drawing

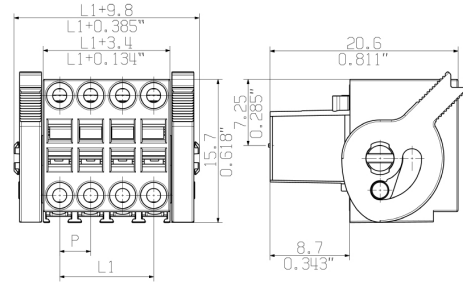

Graph

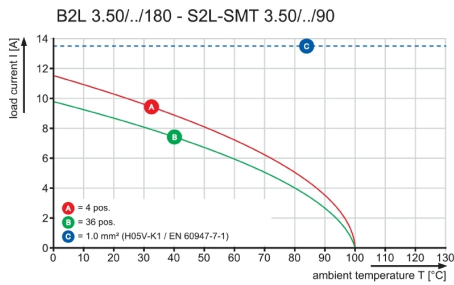

Graph

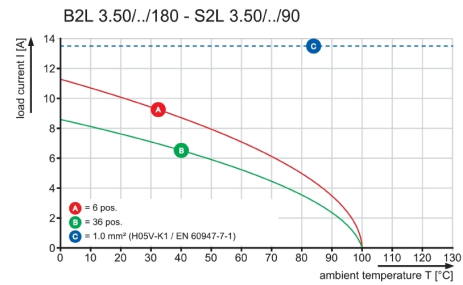

Graph

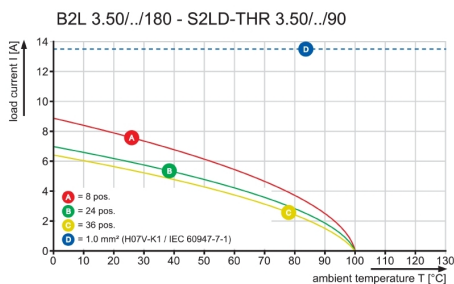

B2L 3.50/12/180LH SN OR BX

Weidmüller Interface GmbH & Co. KG
 Klingenbergstraße 26
 D-32758 Detmold
 Germany

www.weidmueller.com

Accessories

Coding elements



Only connects what is supposed to be connected: the right connection at the right place.

Coding elements and locking devices clearly assign connecting elements during the manufacturing process and operation

The coding elements and locking devices are inserted prior to assembly or during the cable assembly phase. The Weidmüller alternative: configure online using the variant configurator to precode prior to delivery.

Incorrect assembly on the circuit board and incorrect plugging of connecting elements is no longer possible. The advantage: no troubleshooting during manufacture and no operational errors by the user.

General ordering data

Type	B2L/S2L 3.50 KO BK BX	Version	Product data	Packaging
Order No.	1849740000	PCB plug-in connector, Accessories, Coding element, black, Number		Box
GTIN (EAN)	4032248378203	of poles: 1		
Qty.	100 pc(s).			
Type	B2L/S2L 3.50 KO OR BX	Version	Product data	Packaging
Order No.	1849730000	PCB plug-in connector, Accessories, Coding element, orange, Number		Box
GTIN (EAN)	4032248378197	of poles: 1		
Qty.	100 pc(s).			

B2L 3.50/12/180LH SN OR BX

Weidmüller Interface GmbH & Co. KG
 Klingenbergstraße 26
 D-32758 Detmold
 Germany

www.weidmueller.com

Accessories

Cover hoods



Effective protection, optimised ergonomics and closed design:

From the strain relief on the connected conductors and the visual/contact protection and the disconnection aid: the optional retrofit hoods perform mechanical, visual and haptic functions.

The two half shells clip together securely, enclose the plug completely and offer the following functions:

- Cable ties or integrated cable clips provide strain relief.
- Marked with dekafix labels or adhesive strips
- Mounting side by side without losing poles or displacing the pitch
- Compatible: suitable for plugs with or without a flange or mounting bracket
- Flexible: 1-3 cable outlets leading in different directions available depending on the size

Weidmüller hoods offer added stability, better identification, complete compatibility and versatility. The result: maximum reliability and user-friendliness in any application.

General ordering data

Type	B2L 3.50 AH12 BK BX	Version	Product data	Packaging
Order No.	1781590000	PCB plug-in connector, Accessories, Hood, black, Number of poles: 12		Box
GTIN (EAN)	4032248172641			
Qty.	10 pc(s).			

MASSE OHNE TOLERANZ SIND KEINE PRUEFMASSE
 DIMS. WITHOUT TOLERANCE ARE NOT CONTROL DIMS.

DIE DEUTSCHE VERSION IST VERBINDLICH
 THE GERMAN VERSION IS BINDING

WEITERGABE SOWIE VERVIELFAELTIGUNG DIESES DOKUMENTS, VERWERTUNG UND MITTEILUNG SEINES INHALTS SIND VERBOTEN, SOWEIT NICHT AUSDRUECKLICH GESTATTET.
 ZUWIDERHANDLUNGEN VERPFLICHTEN ZU SCHADENERSATZ. ALLE RECHTE FUER DEN FALL DER PATENT-, GEBRAUCHSMUSTER- ODER GESCHMACKSMUSTEREINTRAGUNG VORBEHALTEN.
 THE REPRODUCTION, DISTRIBUTION AND UTILIZATION OF THIS DOCUMENT AS WELL AS THE COMMUNICATION OF ITS CONTENTS TO OTHERS WITHOUT EXPLICIT AUTHORIZATION IS PROHIBITED.
 OFFENDERS WILL BE HELD LIABLE FOR THE PAYMENT OF DAMAGES. WEIDMUELLER EXCLUSIVELY RESERVES THE RIGHT TO FILE FOR PATENTS, UTILITY MODELS OR DESIGNS.
 © WEIDMUELLER INTERFACE GmbH & Co.KG

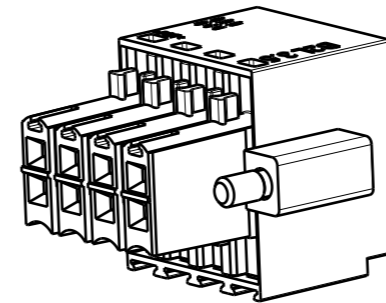
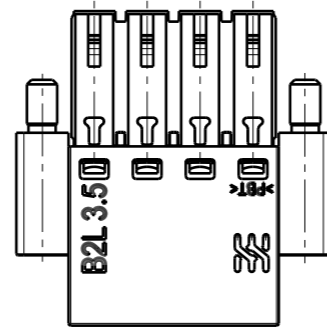
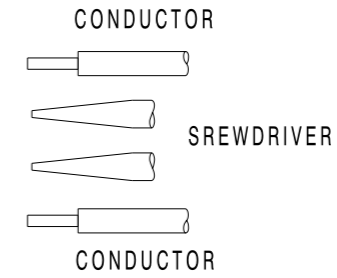
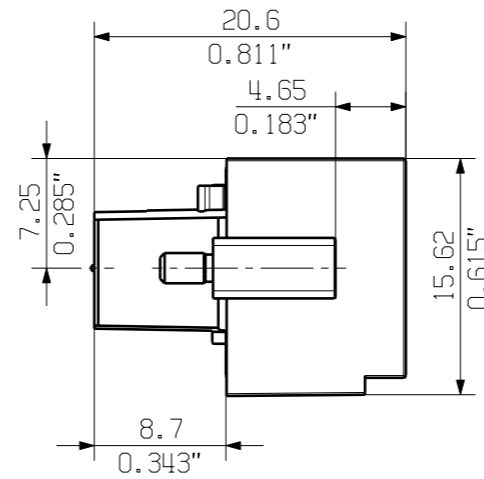
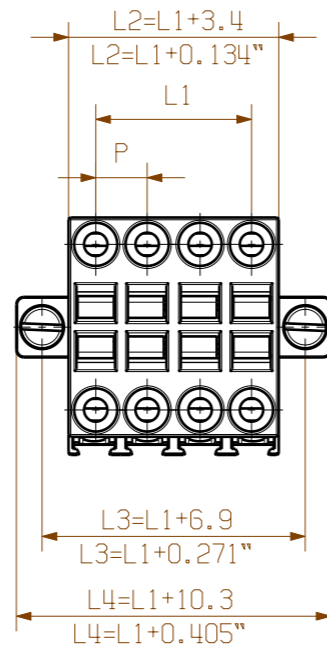

n	L1	L1[inch]	L2	L2[inch]	L3	L3[inch]	L4	L4[inch]
36	59,5	2,344	62,9	2,479	66,4	2,617	69,8	2,751
34	56,0	2,206	59,4	2,341	62,9	2,479	66,3	2,613
32	52,5	2,069	55,9	2,203	59,4	2,341	62,8	2,475
30	49,0	1,931	52,4	2,065	55,9	2,203	59,3	2,337
28	45,5	1,793	48,9	1,927	52,4	2,065	55,8	2,199
26	42,0	1,655	45,4	1,789	48,9	1,927	52,3	2,061
24	38,5	1,517	41,9	1,651	45,4	1,789	48,8	1,923
22	35,0	1,379	38,4	1,513	41,9	1,651	45,3	1,785
20	31,5	1,241	34,9	1,375	38,4	1,513	41,8	1,647
18	28,0	1,103	31,4	1,237	34,9	1,375	38,3	1,509
16	24,5	0,965	27,9	1,099	31,4	1,237	34,8	1,371
14	21,0	0,827	24,4	0,961	27,9	1,099	31,3	1,233
12	17,5	0,690	20,9	0,823	24,4	0,961	27,8	1,095
10	14,0	0,552	17,4	0,685	20,9	0,823	24,3	0,957
8	10,5	0,414	13,9	0,547	17,4	0,685	20,8	0,819
6	7,0	0,276	10,4	0,409	13,9	0,547	17,3	0,681
4	3,5	0,138	6,9	0,271	10,4	0,409	13,8	0,543
n	L1	L1[inch]	L2	L2[inch]	L3	L3[inch]	L4	L4[inch]

n = POLZAHL/NO OF POLES

P = RASTER/PITCH

SHOWN: B2L 3.50/08/180F

For the mounting of PCBs, it should be noted that the rated data given in the catalogue relates only to the connection elements. The necessary creepage and clearance paths must be observed in connection with the respective applicant in accordance to VDE 0110. The current-carrying capacity and pitch tolerance is to be determined according to DIN IEC 326 part 3 very fine.

Weidmüller connectors are tested to the DIN VDE 0627 standard, and are valid for its field of application. Provided that the components are used to the intended purpose, all requirements with respect to the occurring of electrical, mechanical, thermic and corrosive stress will be satisfied.

	DIN ISO 2768-m		CAT.NO.: .	
	69611/5 25.04.13 HELIS_MA 00			
MODIFICATION		DRAWING NO. C 55622 02		ISSUE NO.
DATE		SHEET 02 OF 03 SHEETS		
NAME				
DRAWN 16.01.2012 HELIS_MA				
RESPONSIBLE LANG_T				
CHECKED 22.05.2013 HECKERT_M				
APPROVED HECKERT_M				
SCALE: 2:1				
SUPERSEDES: 26643/31		PRODUCT FILE: B2L 3.50		7110

B2L 3.50/.. /180...
 BUCHSENLEISTE
 SOCKET BLOCK

Mouser Electronics

Authorized Distributor

Click to View Pricing, Inventory, Delivery & Lifecycle Information:

[Weidmuller:](#)

[1748360000](#)