

S2L 3.50/14/90F 3.5SN BK BX

Weidmüller Interface GmbH & Co. KG

Klingenbergstraße 26

D-32758 Detmold

Germany

www.weidmueller.com

Product image

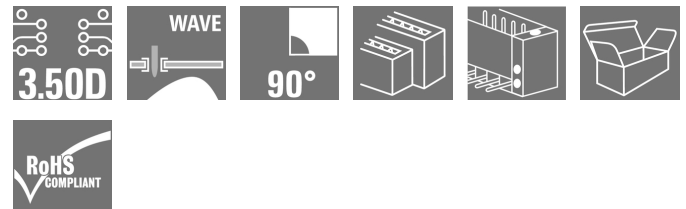

Similar to illustration

Angled, two-tier pin header available as closed-sided or with flange (open-sided pin headers on request). Pin headers with 3.5mm pins are designed for wave soldering and are packaged in a box. They can be screwed on to the PCB. The pin headers provide space for labelling and can be coded.

General ordering data

Version	PCB plug-in connector, male header, Flange, THT solder connection, 3.50 mm, Number of poles: 14, 90°, Solder pin length (l): 3.5 mm, tinned, black, Box
Order No.	1728670000
Type	S2L 3.50/14/90F 3.5SN BK BX
GTIN (EAN)	4032248040131
Qty.	54 pc(s).
Product data	IEC: 250 V / 10 A UL: 150 V / 10 A
Packaging	Box

Creation date January 27, 2022 10:22:58 AM CET

S2L 3.50/14/90F 3.5SN BK BX

Weidmüller Interface GmbH & Co. KG

Klingenbergstraße 26

D-32758 Detmold

Germany

www.weidmueller.com

Technical data

Dimensions and weights

Depth	14.2 mm	Depth (inches)	0.559 inch
Height	14 mm	Height (inches)	0.551 inch
Height of lowest version	10.5 mm	Width	31.5 mm
Width (inches)	1.24 inch	Net weight	4.7 g

System specifications

Product family	OMNIMATE Signal - series B2L/S2L 3.50 - 2-row		
Type of connection	Board connection		
Mounting onto the PCB	THT solder connection		
Pitch in mm (P)	3.5 mm		
Pitch in inches (P)	0.138 inch		
Outgoing elbow	90°		
Number of poles	14		
Number of solder pins per pole	1		
Solder pin length (l)	3.5 mm		
Solder pin dimensions	d = 1.0 mm, Octagonal		
Solder eyelet hole diameter (D)	1.3 mm		
Solder eyelet hole diameter tolerance (D)	+ 0,1 mm		
L1 in mm	21 mm		
L1 in inches	0.827 inch		
Number of rows	1		
Pin series quantity	2		
Touch-safe protection acc. to DIN VDE 57 106	Safe from back-of-hand touch		
Touch-safe protection acc. to DIN VDE 0470	IP 10		
Can be coded	Yes		
Plugging force/pole, max.	5 N		
Pulling force/pole, max.	4 N		
Tightening torque	Torque type	Mounting screw, PCB	
	Usage information	Tightening torque	min. 0.1 Nm max. 0.15 Nm
		Recommended screw	Part number PTSC KA 2.2X4.5 WN1412

Material data

Insulating material	PBT	Colour	black
Colour chart (similar)	RAL 9011	Insulating material group	IIIa
Comparative Tracking Index (CTI)	≥ 200	UL 94 flammability rating	V-0
Contact material	Copper alloy	Contact surface	tinned
Layer structure of solder connection	2...3 µm Ni / 5...7 µm Sn glossy	Storage temperature, min.	-40 °C
Storage temperature, max.	70 °C	Operating temperature, min.	-50 °C
Operating temperature, max.	100 °C	Temperature range, installation, min.	-30 °C
Temperature range, installation, max.	100 °C		

S2L 3.50/14/90F 3.5SN BK BX**Weidmüller Interface GmbH & Co. KG**

Klingenbergstraße 26

D-32758 Detmold

Germany

www.weidmueller.com

Technical data**Rated data acc. to IEC**

tested acc. to standard	IEC 60664-1, IEC 61984	Rated current, min. number of poles (Tu=20°C)	10 A
Rated current, max. number of poles (Tu=20°C)	10 A	Rated current, min. number of poles (Tu=40°C)	9 A
Rated current, max. number of poles (Tu=40°C)	8.5 A	Rated voltage for surge voltage class / pollution degree II/2	250 V
Rated voltage for surge voltage class / pollution degree III/2	125 V	Rated voltage for surge voltage class / pollution degree III/3	80 V
Rated impulse voltage for surge voltage class/ pollution degree II/2	2.5 kV	Rated impulse voltage for surge voltage class/ pollution degree III/2	2.5 kV
Rated impulse voltage for surge voltage class/ contamination degree III/3	2.5 kV	Short-time withstand current resistance	3 x 1s with 77 A

Rated data acc. to CSA

Institute (CSA)		Certificate No. (CSA)	200039-1488444
Rated voltage (Use group B / CSA)	150 V	Rated current (Use group B / CSA)	5 A
Reference to approval values	Specifications are maximum values, details - see approval certificate.		

Rated data acc. to UL 1059

Institute (UR)		Certificate No. (UR)	E60693
Rated voltage (Use group B / UL 1059)	150 V	Rated voltage (Use group C / UL 1059)	50 V
Rated current (Use group B / UL 1059)	10 A	Rated current (Use group C / UL 1059)	10 A
Reference to approval values	Specifications are maximum values, details - see approval certificate.		

Packing

Packaging	Box	VPE length	351 mm
VPE width	135 mm	VPE height	25 mm

Classifications

ETIM 6.0	EC002637	ETIM 7.0	EC002637
ETIM 8.0	EC002637	ECLASS 9.0	27-44-04-02
ECLASS 9.1	27-44-04-02	ECLASS 10.0	27-44-04-02
ECLASS 11.0	27-46-02-01		

S2L 3.50/14/90F 3.5SN BK BX

Weidmüller Interface GmbH & Co. KG
 Klingenbergstraße 26
 D-32758 Detmold
 Germany

www.weidmueller.com

Technical data

Important note

IPC conformity	Conformity: The products are developed, manufactured and delivered according international recognized standards and norms and comply with the assured properties in the data sheet resp. fulfill decorative properties in accordance with IPC-A-610 "Class 2". Further claims on the products can be evaluated on request.
Notes	<ul style="list-style-type: none"> • Additional colours on request • Gold-plated contact surfaces on request • Spacing between rows: see hole layout • Rated current related to rated cross-section & min. No. of poles. • P on drawing = pitch • Rated data refer only to the component itself. Clearance and creepage distances to other components are to be designed in accordance with the relevant application standards. • For additional mechanical support for male connectors with screw flange (...F), we recommend an additional cable gland with fastening screws (sheet metal screw ISO 1481-ST 2.2x4.5 C or ISO 7049-ST 2.2x4.5 C – see Accessories). Cable gland only permitted before soldering.

Approvals

Approvals



ROHS	Conform
UL File Number Search	E60693

Downloads

Approval/Certificate/Document of Conformity	Declaration of the Manufacturer
Engineering Data	CAD data – STEP
Catalogues	Catalogues in PDF-format
Brochures	FL DRIVES EN MB DEVICE MANUF. EN FL DRIVES DE FL BUILDING SAFETY EN FL APPL LED LIGHTING EN FLIndustr.CONTROLS EN FL MACHINE SAFETY EN FL HEATING ELECTR EN FL APPL INVERTER EN FL_BASE_STATION_EN FL ELEVATOR EN FL POWER SUPPLY EN FL 72H SAMPLE SER EN PO OMNIMATE EN PO OMNIMATE EN

S2L 3.50/14/90F 3.5SN BK BX

Weidmüller Interface GmbH & Co. KG
Klingenbergstraße 26
D-32758 Detmold
Germany

www.weidmueller.com

Dimensional drawing

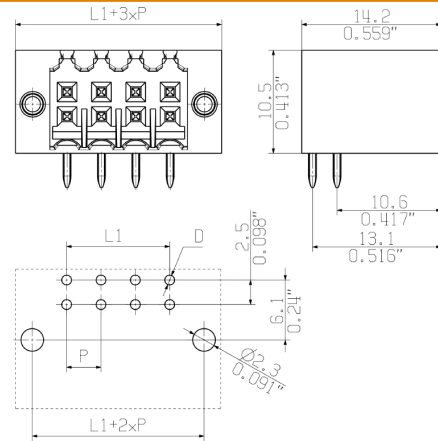

S2L 3.50/14/90F 3.5SN BK BX

Weidmüller Interface GmbH & Co. KG
 Klingenbergstraße 26
 D-32758 Detmold
 Germany

www.weidmueller.com

Accessories

Coding elements



Only connects what is supposed to be connected: the right connection at the right place.

Coding elements and locking devices clearly assign connecting elements during the manufacturing process and operation

The coding elements and locking devices are inserted prior to assembly or during the cable assembly phase. The Weidmüller alternative: configure online using the variant configurator to precode prior to delivery.

Incorrect assembly on the circuit board and incorrect plugging of connecting elements is no longer possible. The advantage: no troubleshooting during manufacture and no operational errors by the user.

General ordering data

Type	B2L/S2L 3.50 KO BK BX	Version	Product data	Packaging
Order No.	1849740000		PCB plug-in connector, Accessories, Coding element, black, Number	Box
GTIN (EAN)	4032248378203		of poles: 1	
Qty.	100 pc(s).			
Type	B2L/S2L 3.50 KO OR BX	Version	Product data	Packaging
Order No.	1849730000		PCB plug-in connector, Accessories, Coding element, orange, Number	Box
GTIN (EAN)	4032248378197		of poles: 1	
Qty.	100 pc(s).			

S2L 3.50/14/90F 3.5SN BK BX

Weidmüller Interface GmbH & Co. KG
 Klingenbergstraße 26
 D-32758 Detmold
 Germany

www.weidmueller.com

Accessories

LED Light guides



Effective: the link between LED and front panel.

Floodlight indicators allow users to monitor the switching states without requiring a special design: optical plastic directs the light from standard LEDs around a bend into the connectors or through the front plate.

The fibre-optic elements are simply clipped behind the relevant 90° bend male connectors (90° outlet direction). Versions with different incoming light beam heights achieve maximum light efficiency for LEDs with different designs or heights.

The advantages compared to conventional solutions:

- No additional LED circuit board required behind the front panel
- No "long-legged" LEDs with separate mounting required
- Bent fibre-optic cable line for maximum light efficiency
- Uncomplicated front plate bore holes due to circular shape of outgoing light beam
- Easy to maintain correct clearance and creepage distance
- Can be partitioned for smaller pole numbers

The result: simplified manufacturing process, reduced costs and simplified design

General ordering data

Type	S2L/S2C 3.5 FLA 20/10	Version	Product data	Packaging
Order No.	1699580000	PCB plug-in connector, Accessories, Flood-light display, Transparent,		Box
GTIN (EAN)	4008190891350	Number of poles: 10		
Qty.	100 pc(s).			

S2L 3.50/14/90F 3.5SN BK BX

Weidmüller Interface GmbH & Co. KG
 Klingenbergstraße 26
 D-32758 Detmold
 Germany

www.weidmueller.com

Accessories

Additional accessories



No task is too small when creating the perfect solution. br />

Connections form just one part of the overall process. Small details are often the key to the perfect solution in applications where potentials are tested, grouped or even isolated.

A system is not a system without small but useful details:

- Test plugs - ensure reliable pick-up from diagnostic sockets
- Cross-connectors - ensure a stable electrical distribution contact directly at the connection
- Compartment partition elements - divide a large number of male connectors into several separate socket connector channels
- Locks and clips - optional vibration-resistant clip-on connection or mounting for male and female connectors

In tandem with the manufacturing process and application - more accessories = smaller workload

General ordering data

Type	PTSC KA 2.2X4.5 WN1412	Version	Product data
Order No.	1610740000	PCB plug-in connector, Accessories, Mounting screw, Number of	
GTIN (EAN)	4008190039523	poles: 1	
Qty.	100 pc(s).		

The reproduction, distribution and utilization of this document as well as the communication of its contents to others without explicit authorization is prohibited. Offenders will be held liable for the payment of damages. Weidmueller exclusively reserves the right to file for patents, utility models or designs.

© Weidmueller Interface GmbH & Co. KG

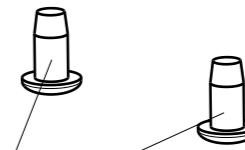
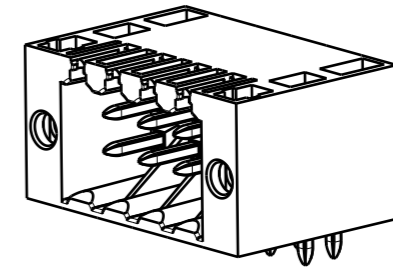
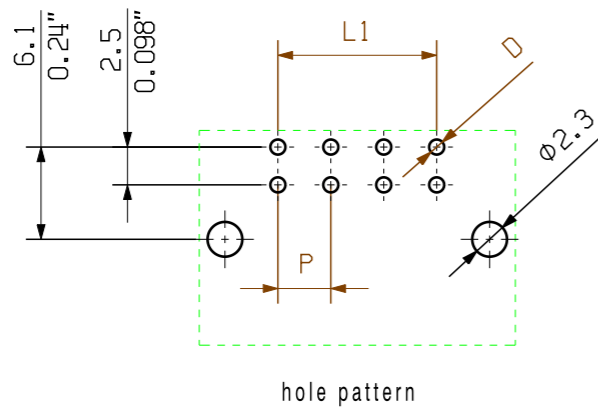
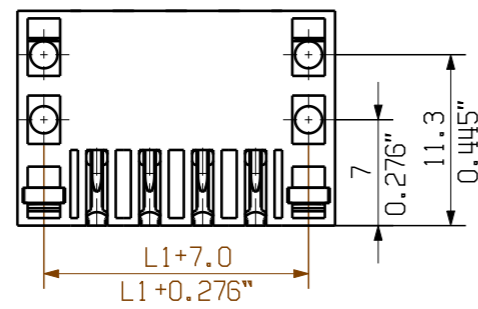
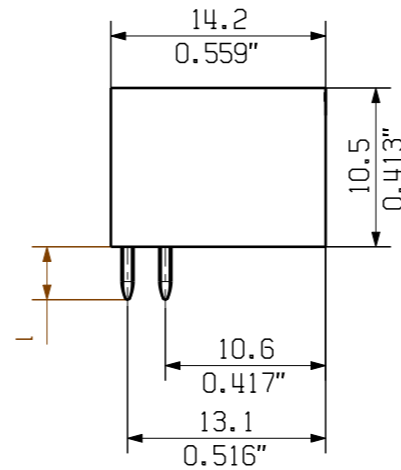
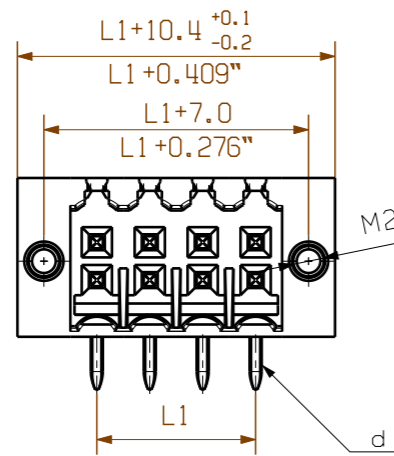

optional fixing screw
order no.: 161074 0000

P = 3.50 Raster Pitch
D = Ø1,3^{+0.1}
Ø0.051^{+0.1}
d = 1mm oktogonal
0.039" octogonal

shown: S2L 3.50/08/90F

pin length l	tolerance
3,5	0,2 -0,2
2,6	0,2 -0,2

n	Polzahl/ no of poles	L1	Toleranz/ tolerance L1
46	77.0		
44	73.5		
42	70.0		
40	66.5		
38	63.0		+/-0.2
36	59.5		
34	56.0		
32	52.5		
30	49.0		
28	45.5		
26	42.0		
24	38.5		+/-0.15
22	35.0		
20	31.5		
18	28.0		
16	24.5		
14	21.0		
12	17.5		+/-0.1
10	14.0		
8	10.5		
6	7.0		
4	3.5		

For the mounting of PCBs, it should be noted that the rated data given in the catalogue relates only to the connection elements. The necessary creepage and clearance paths must be observed in connection with the respective applicant in accordance with VDE 0110. The current-carrying capacity and pitch tolerance is to be determined according to DIN IEC 326 part 3 very fine.

Weidmueller connectors are tested to the DIN VDE 0627 standard, and are valid for its field of application. Provided that the connectors are used to the intended purpose, all requirements with respect to the occurring of electrical, mechanical, thermic and corrosive stress will be satisfied.

General tolerance: DIN ISO 2768-mK		98746/5 29.11.17 HELIS_MA 01		Cat.no.: .											
		Modification													
		<table border="1"> <tr><td>Drawn</td><td>28.11.2008</td><td>HELIS_MA</td></tr> <tr><td>Responsible</td><td></td><td>AMANN_A</td></tr> <tr><td>Checked</td><td>04.12.2017</td><td>HELIS_MA</td></tr> <tr><td>Approved</td><td></td><td>LANG_T</td></tr> </table>		Drawn	28.11.2008	HELIS_MA	Responsible		AMANN_A	Checked	04.12.2017	HELIS_MA	Approved		LANG_T
Drawn	28.11.2008	HELIS_MA													
Responsible		AMANN_A													
Checked	04.12.2017	HELIS_MA													
Approved		LANG_T													
Scale: 5/1		Product file: S2L 3.50		S2L 3.50/.../... STIFTLEISTE MALE HEADER											
Supersedes: .		7110													

Recommended wave soldering profiles

Weidmüller Interface GmbH & Co. KG
 Klängenbergstraße 16
 D-32758 Detmold
 Germany
 Fon: +49 5231 14-0
 Fax: +49 5231 14-292083
 www.weidmueller.com

Single Wave:



Double Wave:



Wave soldering profiles

Wired connection elements should be processed in accordance with the DIN EN 61760-1 standard. We have included two recommendations for practical wave soldering profiles, with which Weidmüller PCB terminals and connectors are qualified.

When choosing a suitable profile for your application, the following factors also need to be considered:

- PCB thickness
- Proportion of Cu in the layers
- Single/double-sided assembly
- Product range
- Heating and cooling rates

The single and double wave profiles each indicate the recommended operating range, including the maximum soldering temperature of 260°C. In practice, the maximum soldering temperature is quite often well below the above maximum profile.

Mouser Electronics

Authorized Distributor

Click to View Pricing, Inventory, Delivery & Lifecycle Information:

[Weidmuller:](#)

[1728670000](#)