

## B2CF 3.50/06/180LR SN BK BX

Weidmüller Interface GmbH & Co. KG

Klingenbergstraße 26

D-32758 Detmold

Germany

www.weidmueller.com

### Product image

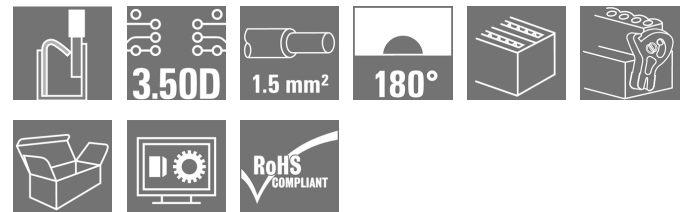

### Two-row female plug with PUSH IN spring connection

- Simply insert the prepared wire - and you're done
- Intuitive to use because
- the wire-entry area and handling area are clearly separated
- Integrated push-buttons for opening the terminal point
- High component density because of low heights
- Optional: locking and releasing require no tools when using Weidmüller's release latch (LR) or release lever (LH)

### General ordering data

|              |  |
|--------------|--|
| Version      | PCB plug-in connector, female plug, 3.50 mm,<br>Number of poles: 6, 180°, PUSH IN with actuator,<br>Tension-clamp connection, Clamping range, max. :<br>1.5 mm², Box |
| Order No.    | <a href="#">1278240000</a>   |
| Type         | B2CF 3.50/06/180LR SN BK BX  |
| GTIN (EAN)   | 4050118069228  |
| Qty.         | 108 pc(s).   |
| Product data | IEC: 320 V / 13.4 A / 0.14 - 1.5 mm²<br>UL: 300 V / 9.5 A / AWG 30 - AWG 16  |
| Packaging    | Box  |

Creation date January 22, 2022 7:41:21 AM CET

**B2CF 3.50/06/180LR SN BK BX****Weidmüller Interface GmbH & Co. KG**

Klingenbergstraße 26

D-32758 Detmold

Germany

www.weidmueller.com

**Technical data****Dimensions and weights**

|            |          |                 |            |
|------------|----------|-----------------|------------|
| Depth      | 29.9 mm  | Depth (inches)  | 1.177 inch |
| Height     | 17.25 mm | Height (inches) | 0.679 inch |
| Width      | 17.4 mm  | Width (inches)  | 0.685 inch |
| Net weight | 4.704 g  |                 |            |

**System Parameters**

|   |  |   |                     |
|---|--|---|---------------------|
| Product family                                  | OMNIMATE Signal - series<br>B2C/S2C 3.50 - 2-row   | Type of connection                            | Field connection    |
| Wire connection method                          | PUSH IN with actuator,<br>Tension-clamp connection | Pitch in mm (P)                               | 3.5 mm              |
| Pitch in inches (P)                             | 0.138 inch   | Conductor outlet direction                    | 180°                |
| Number of poles                                 | 6  | L1 in mm                                      | 7 mm                |
| L1 in inches                                    | 0.276 inch   | Number of rows                                | 1                   |
| Pin series quantity                             | 2  | Rated cross-section                           | 1.5 mm <sup>2</sup> |
| Touch-safe protection acc. to DIN VDE<br>57 106 | Safe from finger touch                             | Touch-safe protection acc. to DIN VDE<br>0470 | IP 20               |
| Can be coded                                    | Yes  | Stripping length                              | 10 mm               |
| Screwdriver blade                               | 0.4 x 2.5  | Screwdriver blade standard                    | DIN 5264            |
| Plugging cycles                                 | 25   | Plugging force/pole, max.                     | 5 N                 |
| Pulling force/pole, max.                        | 5 N  |   |                     |

**Material data**

|                                       |             |                                       |                            |
|---------------------------------------|-------------|---------------------------------------|----------------------------|
| Insulating material                   | PA 66 GF 30 | Colour                                | black                      |
| Colour chart (similar)                | RAL 9011    | Insulating material group             | II                         |
| Comparative Tracking Index (CTI)      | ≥ 600       | Insulation strength                   | ≥ 10 <sup>8</sup> Ω        |
| UL 94 flammability rating             | V-0         | Contact material                      | Copper alloy               |
| Contact surface                       | tinned      | Layer structure of plug contact       | 2...5 μm Sn hot-dip tinned |
| Storage temperature, min.             | -40 °C      | Storage temperature, max.             | 70 °C                      |
| Operating temperature, min.           | -50 °C      | Operating temperature, max.           | 120 °C                     |
| Temperature range, installation, min. | -40 °C      | Temperature range, installation, max. | 120 °C                     |

**Conductors suitable for connection**

|  |                      |
|--|----------------------|
| Clamping range, min.                               | 0.14 mm <sup>2</sup> |
| Clamping range, max.                               | 1.5 mm <sup>2</sup>  |
| Wire connection cross section AWG,<br>min.         | AWG 30               |
| Wire connection cross section AWG,<br>max.         | AWG 16               |
| Solid, min. H05(07) V-U                            | 0.14 mm <sup>2</sup> |
| Solid, max. H05(07) V-U                            | 1.5 mm <sup>2</sup>  |
| Flexible, min. H05(07) V-K                         | 0.14 mm <sup>2</sup> |
| Flexible, max. H05(07) V-K                         | 1.5 mm <sup>2</sup>  |
| w. plastic collar ferrule, DIN 46228 pt 4,<br>min. | 0.14 mm <sup>2</sup> |
| w. plastic collar ferrule, DIN 46228 pt 4,<br>max. | 1 mm <sup>2</sup>    |
| w. wire end ferrule, DIN 46228 pt 1,<br>min.       | 0.14 mm <sup>2</sup> |
| w. wire end ferrule, DIN 46228 pt 1,<br>max.       | 1.5 mm <sup>2</sup>  |

**B2CF 3.50/06/180LR SN BK BX****Weidmüller Interface GmbH & Co. KG**

Klingenbergstraße 26

D-32758 Detmold

Germany

www.weidmueller.com

**Technical data**

|  |  |                              |                            |       |
|--|--|------------------------------|----------------------------|-------|
| Clampable conductor                    | Cross-section for conductor connection | Type                         | fine-wired                 |       |
|  |  | nominal                      | 0.5 mm <sup>2</sup>        |       |
|  | wire end ferrule                       | Stripping length             | nominal                    | 12 mm |
|  |  | Recommended wire-end ferrule | <a href="#">H0.5/16 OR</a> |       |
|  |  | Stripping length             | nominal                    | 10 mm |
|  |  | Recommended wire-end ferrule | <a href="#">H0.5/10</a>    |       |
|  | Cross-section for conductor connection | Type                         | fine-wired                 |       |
|  |  | nominal                      | 0.75 mm <sup>2</sup>       |       |
|  | wire end ferrule                       | Stripping length             | nominal                    | 14 mm |
|  |  | Recommended wire-end ferrule | <a href="#">H0.75/18 W</a> |       |
|  |  | Stripping length             | nominal                    | 10 mm |
|  |  | Recommended wire-end ferrule | <a href="#">H0.75/10</a>   |       |
| Cross-section for conductor connection | Type                                   | fine-wired                   |                            |       |
|  | nominal                                | 1 mm <sup>2</sup>            |                            |       |
| wire end ferrule                       | Stripping length                       | nominal                      | 15 mm                      |       |
|  | Recommended wire-end ferrule           | <a href="#">H1.0/18D R</a>   |                            |       |
|  | Stripping length                       | nominal                      | 10 mm                      |       |
|  | Recommended wire-end ferrule           | <a href="#">H1.0/10</a>      |                            |       |
| Cross-section for conductor connection | Type                                   | fine-wired                   |                            |       |
|  | nominal                                | 1.5 mm <sup>2</sup>          |                            |       |
| wire end ferrule                       | Stripping length                       | nominal                      | 10 mm                      |       |
|  | Recommended wire-end ferrule           | <a href="#">H1.5/10</a>      |                            |       |

Reference text The outside diameter of the plastic collar should not be larger than the pitch (P), Length of ferrules is to be chosen depending on the product and the rated voltage.

**Rated data acc. to IEC**

|   |                        |   |                  |
|---|------------------------|---|------------------|
| tested acc. to standard   | IEC 60664-1, IEC 61984 | Rated current, min. number of poles (Tu=20°C)                         | 13.4 A           |
| Rated current, max. number of poles (Tu=20°C)                             | 10 A                   | Rated current, min. number of poles (Tu=40°C)                         | 12 A             |
| Rated current, max. number of poles (Tu=40°C)                             | 9 A                    | Rated voltage for surge voltage class / pollution degree II/2         | 320 V            |
| Rated voltage for surge voltage class / pollution degree III/2            | 160 V                  | Rated voltage for surge voltage class / pollution degree III/3        | 160 V            |
| Rated impulse voltage for surge voltage class/ pollution degree II/2      | 2.5 kV                 | Rated impulse voltage for surge voltage class/ pollution degree III/2 | 2.5 kV           |
| Rated impulse voltage for surge voltage class/ contamination degree III/3 | 2.5 kV                 | Short-time withstand current resistance                               | 3 x 1s with 80 A |

**B2CF 3.50/06/180LR SN BK BX****Weidmüller Interface GmbH & Co. KG**

Klingenbergstraße 26

D-32758 Detmold

Germany

www.weidmueller.com

**Technical data****Rated data acc. to CSA**

Institute (CSA)



Certificate No. (CSA)

200039-1121690

|                                   |  |
|-----------------------------------|--|
| Rated voltage (Use group B / CSA) | 300 V  |
| Rated voltage (Use group D / CSA) | 300 V  |
| Rated current (Use group C / CSA) | 9.5 A  |
| Wire cross-section, AWG, min.     | AWG 30   |
| Reference to approval values      | Specifications are maximum values, details - see approval certificate. |

|                                   |        |
|-----------------------------------|--------|
| Rated voltage (Use group C / CSA) | 50 V   |
| Rated current (Use group B / CSA) | 9.5 A  |
| Rated current (Use group D / CSA) | 9.5 A  |
| Wire cross-section, AWG, max.     | AWG 16 |

**Rated data acc. to UL 1059**

Institute (cURus)



Certificate No. (cURus)

E60693

|                                       |  |
|---------------------------------------|--|
| Rated voltage (Use group B / UL 1059) | 300 V  |
| Rated voltage (Use group D / UL 1059) | 300 V  |
| Rated current (Use group C / UL 1059) | 9.5 A  |
| Wire cross-section, AWG, min.         | AWG 30   |
| Reference to approval values          | Specifications are maximum values, details - see approval certificate. |

|                                       |        |
|---------------------------------------|--------|
| Rated voltage (Use group C / UL 1059) | 50 V   |
| Rated current (Use group B / UL 1059) | 9.5 A  |
| Rated current (Use group D / UL 1059) | 9.5 A  |
| Wire cross-section, AWG, max.         | AWG 16 |

**Packing**

|           |        |            |        |
|-----------|--------|------------|--------|
| Packaging | Box    | VPE length | 350 mm |
| VPE width | 135 mm | VPE height | 41 mm  |

**Type tests**

|  |            |   |
|--|------------|---|
| Test: Durability of markings                 | Standard   | IEC 61984 section 6.2 and 7.3.2 / 10.11 taking pattern from IEC 60068-2-70 / 12.95                                    |
|  | Test       | mark of origin, type identification, pitch, type of material, date clock, approval marking UL, approval marking cULus |
|  | Evaluation | available   |
|  | Test       | durability  |
|  | Evaluation | passed  |
| Test: Misengagement (Non-interchangeability) | Standard   | IEC 61984 section 6.3 and 6.9.1 / 10.11, IEC 60512-13-5 / 02.06   |
|  | Test       | 180° turned without coding elements   |
|  | Evaluation | passed  |
|  | Test       | 180° turned with coding elements  |
|  | Evaluation | passed  |
|  | Test       | visual examination  |
|  | Evaluation | passed  |

**B2CF 3.50/06/180LR SN BK BX**

**Weidmüller Interface GmbH & Co. KG**  
 Klingenbergstraße 26  
 D-32758 Detmold  
 Germany

www.weidmueller.com

**Technical data**

|   |                |  |                               |
|---|----------------|--|-------------------------------|
| Test: Clampable cross section                             | Standard       | IEC 60999-1 section 7 and 9.1 / 11.99, IEC 60947-1 section 8.2.4.5.1 / 03.11 |                               |
|   | Conductor type | Type of conductor and conductor cross-section                                | solid 0.14 mm <sup>2</sup>    |
|   |                | Type of conductor and conductor cross-section                                | stranded 0.14 mm <sup>2</sup> |
|   |                | Type of conductor and conductor cross-section                                | solid 1.5 mm <sup>2</sup>     |
|   |                | Type of conductor and conductor cross-section                                | stranded 1.5 mm <sup>2</sup>  |
|   |                | Type of conductor and conductor cross-section                                | AWG 26/1                      |
|   |                | Type of conductor and conductor cross-section                                | AWG 26/19                     |
|   |                | Type of conductor and conductor cross-section                                | AWG 16/1                      |
|   |                | Type of conductor and conductor cross-section                                | AWG 16/19                     |
| Evaluation  | passed         |  |                               |
| Test for damage to and accidental loosening of conductors | Standard       | IEC 60999-1 section 9.4 / 11.99  |                               |
|   | Requirement    | 0.2 kg   |                               |
|   | Conductor type | Type of conductor and conductor cross-section                                | AWG 26/1                      |
|   |                | Type of conductor and conductor cross-section                                | AWG 26/19                     |
|   | Evaluation     | passed   |                               |
|   | Requirement    | 0.3 kg   |                               |
|   | Conductor type | Type of conductor and conductor cross-section                                | H05V-U0.75                    |
|   |                | Type of conductor and conductor cross-section                                | H05V-K0.75                    |
|   | Evaluation     | passed   |                               |
|   | Requirement    | 0.4 kg   |                               |
|   | Conductor type | Type of conductor and conductor cross-section                                | H07V-U1.5                     |
|   |                | Type of conductor and conductor cross-section                                | H07V-K1.5                     |
|   |                | Type of conductor and conductor cross-section                                | AWG 16/1                      |
|   |                | Type of conductor and conductor cross-section                                | AWG 16/19                     |
| Evaluation  | passed         |  |                               |

**B2CF 3.50/06/180LR SN BK BX**

**Weidmüller Interface GmbH & Co. KG**  
 Klingenbergstraße 26  
 D-32758 Detmold  
 Germany

www.weidmueller.com

**Technical data**

|               |                |   |            |  |
|---------------|----------------|---|------------|--|
| Pull-out test | Standard       | IEC 60999-1 section 9.5 / 11.99               |            |  |
|               | Requirement    | ≥10 N   |            |  |
|               | Conductor type | Type of conductor and conductor cross-section | AWG 26/1   |  |
|               |                | Type of conductor and conductor cross-section | AWG 26/19  |  |
|               | Evaluation     | passed  |            |  |
|               | Requirement    | ≥20 N   |            |  |
|               | Conductor type | Type of conductor and conductor cross-section | H05V-U0.75 |  |
|               |                | Type of conductor and conductor cross-section | H05V-K0.75 |  |
|               | Evaluation     | passed  |            |  |
|               | Requirement    | ≥40 N   |            |  |
|               | Conductor type | Type of conductor and conductor cross-section | H07V-U1.5  |  |
|               |                | Type of conductor and conductor cross-section | H07V-K1.5  |  |
|               |                | Type of conductor and conductor cross-section | AWG 16/1   |  |
|               |                | Type of conductor and conductor cross-section | AWG 16/19  |  |
|               | Evaluation     | passed  |            |  |

**Classifications**

|             |             |             |             |
|-------------|-------------|-------------|-------------|
| ETIM 6.0    | EC002638    | ETIM 7.0    | EC002638    |
| ETIM 8.0    | EC002638    | ECLASS 9.0  | 27-44-03-09 |
| ECLASS 9.1  | 27-44-03-09 | ECLASS 10.0 | 27-44-03-09 |
| ECLASS 11.0 | 27-46-02-02 |             |             |

**B2CF 3.50/06/180LR SN BK BX**

**Weidmüller Interface GmbH & Co. KG**  
 Klingenbergstraße 26  
 D-32758 Detmold  
 Germany

www.weidmueller.com

**Technical data**

**Important note**

|                |   |
|----------------|---|
| IPC conformity | Conformity: The products are developed, manufactured and delivered according international recognized standards and norms and comply with the assured properties in the data sheet resp. fulfill decorative properties in accordance with IPC-A-610 "Class 2". Further claims on the products can be evaluated on request.  |
| Notes          | <ul style="list-style-type: none"> <li>• Additional colours on request</li> <li>• Gold-plated contact surfaces on request</li> <li>• Rated current related to rated cross-section &amp; min. No. of poles.</li> <li>• Crimp shape A for wire-end ferrules with crimping tools PZ 1,5 (order no. 9005990000) or PZ 6/5 (order no. 9011460000) for larger wire cross-sections recommended.</li> <li>• P on drawing = pitch</li> <li>• Rated data refer only to the component itself. Clearance and creepage distances to other components are to be designed in accordance with the relevant application standards.</li> <li>• Max. outer diameter of the conductor 2.6 mm</li> </ul> <p>Wire-end ferrule w/plastic collar DIN 46228/4 or Weidmüller colour code</p> <ul style="list-style-type: none"> <li>• 1.00mm<sup>2</sup> [H1.0/18D] mtl. ferrule leng. 12mm, stripping leng. 15mm</li> <li>• 0.75mm<sup>2</sup> [H0.75/18D] mtl. ferrule leng. 12mm, stripping leng. 14mm</li> <li>• 0.50mm<sup>2</sup> [H0.5/16D] mtl. ferrule leng. 10mm, stripping leng. 12mm</li> <li>• 0.34mm<sup>2</sup> [H0.34/12] mtl. ferrule leng. 8mm, stripping leng. 10mm</li> <li>• 0.25mm<sup>2</sup> [H0.25/12] mtl. ferrule leng. 8mm, stripping leng. 10mm</li> <li>• 0.14mm<sup>2</sup> [H0.14/12] mtl. ferrule leng. 8mm, stripping leng. 10mm</li> </ul> <p>Wire-end ferrule w/o plastic collar acc. to DIN 46228/1</p> <ul style="list-style-type: none"> <li>• 1.50mm<sup>2</sup> [H1.5/10] mtl. ferrule leng. 10mm, stripping leng. 10mm</li> </ul> |

**Approvals**

Approvals



|                       |         |
|-----------------------|---------|
| ROHS                  | Conform |
| UL File Number Search | E60693  |

## B2CF 3.50/06/180LR SN BK BX

**Weidmüller Interface GmbH & Co. KG**  
Klingenbergstraße 26  
D-32758 Detmold  
Germany

[www.weidmueller.com](http://www.weidmueller.com)

# Technical data

## Downloads

|   |  |
|---|--|
| Approval/Certificate/Document of Conformity | <a href="#">Declaration of the Manufacturer</a>  |
| Engineering Data                            | <a href="#">CAD data – STEP</a>  |
| Engineering Data                            | <a href="#">EPLAN, WSCAD</a>   |
| Product Change Notification                 | <a href="#">Change of Material LR 3.50 - DE</a><br><a href="#">Change of Material LR 3.50 - EN</a><br><a href="#">20210721 Technical change Redesign B2CF 3.50</a><br><a href="#">20210721 Technische Änderung Redesign zu B2CF 3.50</a>   |
| User Documentation                          | <a href="#">Operating instruction</a>  |
| Catalogues                                  | <a href="#">Catalogues in PDF-format</a>   |
| Brochures                                   | <a href="#">FL DRIVES EN</a><br><a href="#">MB DEVICE MANUF. EN</a><br><a href="#">FL DRIVES DE</a><br><a href="#">FL BUILDING SAFETY EN</a><br><a href="#">FL APPL LED LIGHTING EN</a><br><a href="#">FL INDUSTR.CONTROLS EN</a><br><a href="#">FL MACHINE SAFETY EN</a><br><a href="#">FL HEATING ELECTR EN</a><br><a href="#">FL APPL INVERTER EN</a><br><a href="#">FL_BASE_STATION_EN</a><br><a href="#">FL ELEVATOR EN</a><br><a href="#">FL POWER SUPPLY EN</a><br><a href="#">FL 72H SAMPLE SER EN</a><br><a href="#">PO OMNIMATE EN</a><br><a href="#">PO OMNIMATE EN</a> |



**B2CF 3.50/06/180LR SN BK BX**

**Weidmüller Interface GmbH & Co. KG**  
 Klingenbergstraße 26  
 D-32758 Detmold  
 Germany

www.weidmueller.com

Drawings

Product image

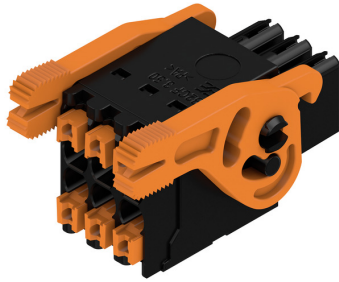

Dimensional drawing

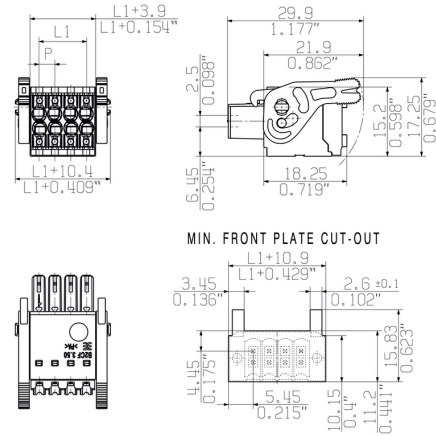

Graph

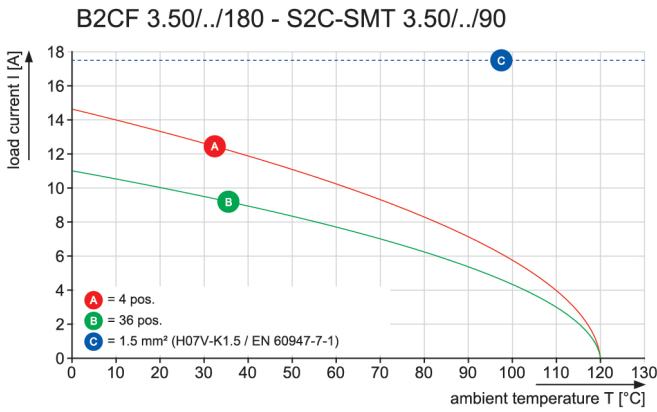

Product benefits

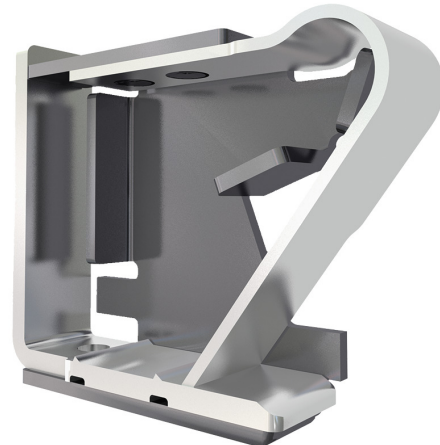

Solid PUSH IN contact  
 Safe and durable

Product benefits

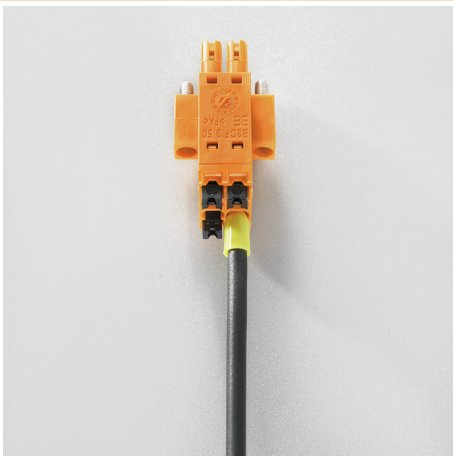

Large connection cross-section  
 Up to 1.5 mm possible with ease

Product benefits

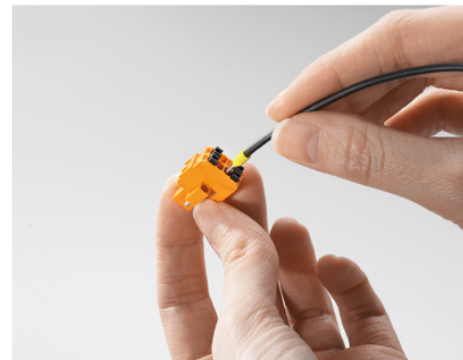

Fast PUSH IN connection  
 Tool-free and touch-safe

## B2CF 3.50/06/180LR SN BK BX

**Weidmüller Interface GmbH & Co. KG**  
 Klingenbergstraße 26  
 D-32758 Detmold  
 Germany

www.weidmueller.com

# Accessories

## Coding elements



**Only connects what is supposed to be connected: the right connection at the right place.**

Coding elements and locking devices clearly assign connecting elements during the manufacturing process and operation

The coding elements and locking devices are inserted prior to assembly or during the cable assembly phase. The Weidmüller alternative: configure online using the variant configurator to precode prior to delivery.

Incorrect assembly on the circuit board and incorrect plugging of connecting elements is no longer possible. The advantage: no troubleshooting during manufacture and no operational errors by the user.

## General ordering data

| Type       | B2L/S2L 3.50 KO BK BX      | Version  | Product data | Packaging |
|------------|----------------------------|--|--------------|-----------|
| Order No.  | <a href="#">1849740000</a> | PCB plug-in connector, Accessories, Coding element, black, Number  |              | Box       |
| GTIN (EAN) | 4032248378203              | of poles: 1  |              |           |
| Qty.       | 100 pc(s).                 |  |              |           |
| Type       | B2L/S2L 3.50 KO OR BX      | Version  | Product data | Packaging |
| Order No.  | <a href="#">1849730000</a> | PCB plug-in connector, Accessories, Coding element, orange, Number |              | Box       |
| GTIN (EAN) | 4032248378197              | of poles: 1  |              |           |
| Qty.       | 100 pc(s).                 |  |              |           |

**B2CF 3.50/06/180LR SN BK BX**

**Weidmüller Interface GmbH & Co. KG**  
Klingenbergstraße 26  
D-32758 Detmold  
Germany

[www.weidmueller.com](http://www.weidmueller.com)

**Drawings**

**Example of use**





# Mouser Electronics

Authorized Distributor

Click to View Pricing, Inventory, Delivery & Lifecycle Information:

[Weidmuller:](#)

[1278240000](#)