

SAIE-M23-S-EM**Weidmüller Interface GmbH & Co. KG**

Klingenbergstraße 26

D-32758 Detmold

Germany

www.weidmueller.com



The M23 round plug-in connectors offer a high number of mating cycles, high current-carrying capacity and high contact-density coupled with minimum dimensions. Enclosures, inserts and crimp contacts need to be ordered separately.

General ordering data

Version	Sensor/Actuator plug-in connector, Built-in plugs, Empty enclosure
Order No.	1169970000
Type	SAIE-M23-S-EM
GTIN (EAN)	4032248961979
Qty.	1 pc(s).

Creation date January 21, 2022 4:37:35 PM CET

Catalogue status 14.01.2022 / We reserve the right to make technical changes.

SAIE-M23-S-EM**Weidmüller Interface GmbH & Co. KG**

Klingenbergstraße 26

D-32758 Detmold

Germany

www.weidmueller.com

Technical data**Dimensions and weights**

Net weight 40 g

Environmental Product Compliance

REACH SVHC Lead 7439-92-1

Technical data customisable plug-in connectors

Housing main material	Copper-zinc alloy	Pollution severity	3
Protection degree	IP67, IP69K	Shield connection	Yes
Temperature range of housing	-40...+125 °C		

Classifications

ETIM 6.0	EC000437	ETIM 7.0	EC003556
ETIM 8.0	EC003556	ECLASS 9.1	27-44-02-02
ECLASS 10.0	27-44-02-24	ECLASS 11.0	27-44-02-24

Important note

Product information Enclosures, inserts and crimp contacts need to be ordered separately.

Approvals

Approvals



ROHS	Conform
UL File Number Search	E344862

Downloads

Engineering Data	CAD data – STEP
Catalogues	Catalogues in PDF-format
Brochures	FL FIELDWIRING EN FL FIELDWIRING EN

SAIE-M23-S-EM

Weidmüller Interface GmbH & Co. KG
Klingenbergstraße 26
D-32758 Detmold
Germany

www.weidmueller.com

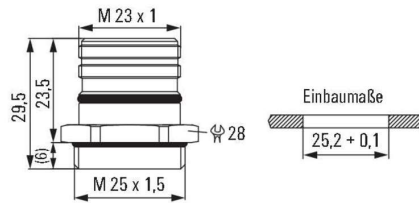
Drawings**Dimensioned drawing**

SAIE-M23-S-EM

Weidmüller Interface GmbH & Co. KG
 Klingenbergstraße 26
 D-32758 Detmold
 Germany

www.weidmueller.com

Accessories

17-pole

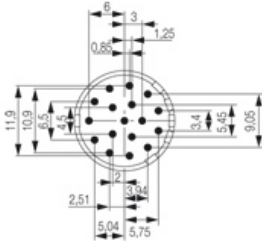

The M23 round plug-in connectors offer a high number of mating cycles, high current-carrying capacity and high contact-density coupled with minimum dimensions. Enclosures, inserts and crimp contacts need to be ordered separately.

General ordering data

Type	SAI-M23-SE-17-17MM-G	Version
Order No.	1224720000	Sensor/Actuator plug-in connector
GTIN (EAN)	4050118008562	
Qty.	1 pc(s).	
Type	SAI-M23-BE-17-17MM-G	Version
Order No.	1224690000	Sensor/Actuator plug-in connector
GTIN (EAN)	4050118008449	
Qty.	1 pc(s).	
Type	SAI-M23-BE-17-17MM	Version
Order No.	1224360000	Sensor/Actuator plug-in connector
GTIN (EAN)	4050118008265	
Qty.	1 pc(s).	
Type	SAI-M23-SE-17-17MM	Version
Order No.	1224380000	Sensor/Actuator plug-in connector
GTIN (EAN)	4050118008159	
Qty.	1 pc(s).	

12-pole

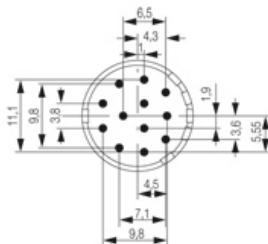

The M23 round plug-in connectors offer a high number of mating cycles, high current-carrying capacity and high contact-density coupled with minimum dimensions. Enclosures, inserts and crimp contacts need to be ordered separately.

General ordering data

Type	SAI-M23-SE-12-17MM-G	Version
Order No.	1224640000	Sensor/Actuator plug-in connector
GTIN (EAN)	4050118008098	
Qty.	1 pc(s).	
Type	SAI-M23-BE-12-17MM	Version
Order No.	1224210000	Sensor/Actuator plug-in connector
GTIN (EAN)	4050118008241	
Qty.	1 pc(s).	

SAIE-M23-S-EM

Weidmüller Interface GmbH & Co. KG
 Klingenbergstraße 26
 D-32758 Detmold
 Germany

www.weidmueller.com

Accessories

Type	SAI-M23-SE-12-17MM	Version
Order No.	1224230000	Sensor/Actuator plug-in connector
GTIN (EAN)	4050118008029	
Qty.	1 pc(s).	

19-pole

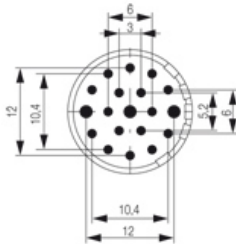

The M23 round plug-in connectors offer a high number of mating cycles, high current-carrying capacity and high contact-density coupled with minimum dimensions. Enclosures, inserts and crimp contacts need to be ordered separately.

General ordering data

Type	SAI-M23-BE-19-17MM	Version
Order No.	1224450000	Sensor/Actuator plug-in connector
GTIN (EAN)	4050118008074	
Qty.	1 pc(s).	

Type	SAI-M23-SE-19-17MM	Version
Order No.	1224480000	Sensor/Actuator plug-in connector
GTIN (EAN)	4050118008593	
Qty.	1 pc(s).	

6-pole

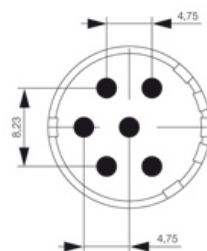

The M23 round plug-in connectors offer a high number of mating cycles, high current-carrying capacity and high contact-density coupled with minimum dimensions. Enclosures, inserts and crimp contacts need to be ordered separately.

General ordering data

Type	SAI-M23-BE-6-17MM	Version
Order No.	1224040000	Sensor/Actuator plug-in connector
GTIN (EAN)	4050118008050	
Qty.	1 pc(s).	

Type	SAI-M23-SE-6-17MM	Version
Order No.	1224060000	Sensor/Actuator plug-in connector
GTIN (EAN)	4050118007657	
Qty.	1 pc(s).	

SAIE-M23-S-EM

Weidmüller Interface GmbH & Co. KG
 Klingenbergstraße 26
 D-32758 Detmold
 Germany

www.weidmueller.com

Accessories

9-pole

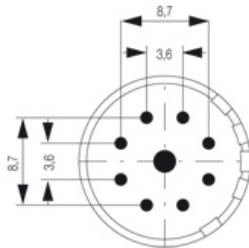

The M23 round plug-in connectors offer a high number of mating cycles, high current-carrying capacity and high contact-density coupled with minimum dimensions. Enclosures, inserts and crimp contacts need to be ordered separately.

General ordering data

Type	SAI-M23-BE-9-17MM	Version
Order No.	1224530000	Sensor/Actuator plug-in connector
GTIN (EAN)	4050118008555	
Qty.	1 pc(s).	
Type	SAI-M23-BE-9-17MM-G	Version
Order No.	1224760000	Sensor/Actuator plug-in connector
GTIN (EAN)	4050118008425	
Qty.	1 pc(s).	
Type	SAI-M23-SE-9-17MM	Version
Order No.	1224550000	Sensor/Actuator plug-in connector
GTIN (EAN)	4050118008364	
Qty.	1 pc(s).	
Type	SAI-M23-SE-9-17MM-G	Version
Order No.	1224780000	Sensor/Actuator plug-in connector
GTIN (EAN)	4050118008579	
Qty.	1 pc(s).	

16-pole

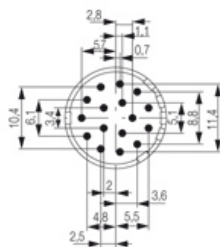

The M23 round plug-in connectors offer a high number of mating cycles, high current-carrying capacity and high contact-density coupled with minimum dimensions. Enclosures, inserts and crimp contacts need to be ordered separately.

General ordering data

Type	SAI-M23-BE-16-17MM	Version
Order No.	1224280000	Sensor/Actuator plug-in connector
GTIN (EAN)	4050118008333	
Qty.	1 pc(s).	
Type	SAI-M23-SE-16-17MM	Version
Order No.	1224310000	Sensor/Actuator plug-in connector
GTIN (EAN)	4050118008258	
Qty.	1 pc(s).	

SAIE-M23-S-EM

Weidmüller Interface GmbH & Co. KG
 Klingenbergstraße 26
 D-32758 Detmold
 Germany

www.weidmueller.com

Accessories

7-pole

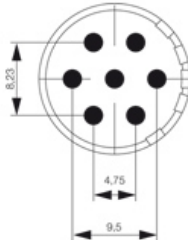

The M23 round plug-in connectors offer a high number of mating cycles, high current-carrying capacity and high contact-density coupled with minimum dimensions. Enclosures, inserts and crimp contacts need to be ordered separately.

General ordering data

Type	SAI-M23-BE-7-17MM	Version
Order No.	1224110000	Sensor/Actuator plug-in connector
GTIN (EAN)	4050118007671	
Qty.	1 pc(s).	
Type	SAI-M23-SE-7-17MM	Version
Order No.	1224130000	Sensor/Actuator plug-in connector
GTIN (EAN)	4050118007664	
Qty.	1 pc(s).	

SAIE-M23-S-EM

Weidmüller Interface GmbH & Co. KG
Klingenbergstraße 26
D-32758 Detmold
Germany

www.weidmueller.com

Drawings

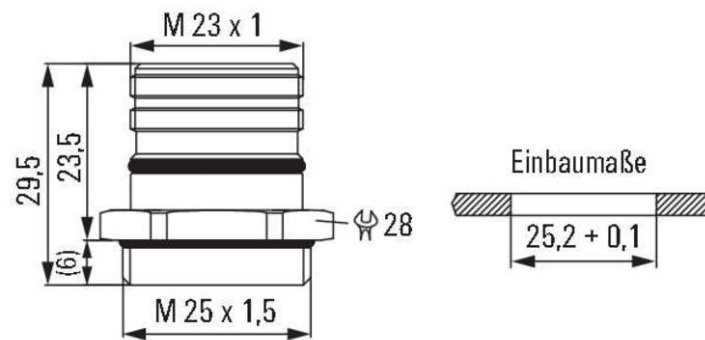

Device connector, male

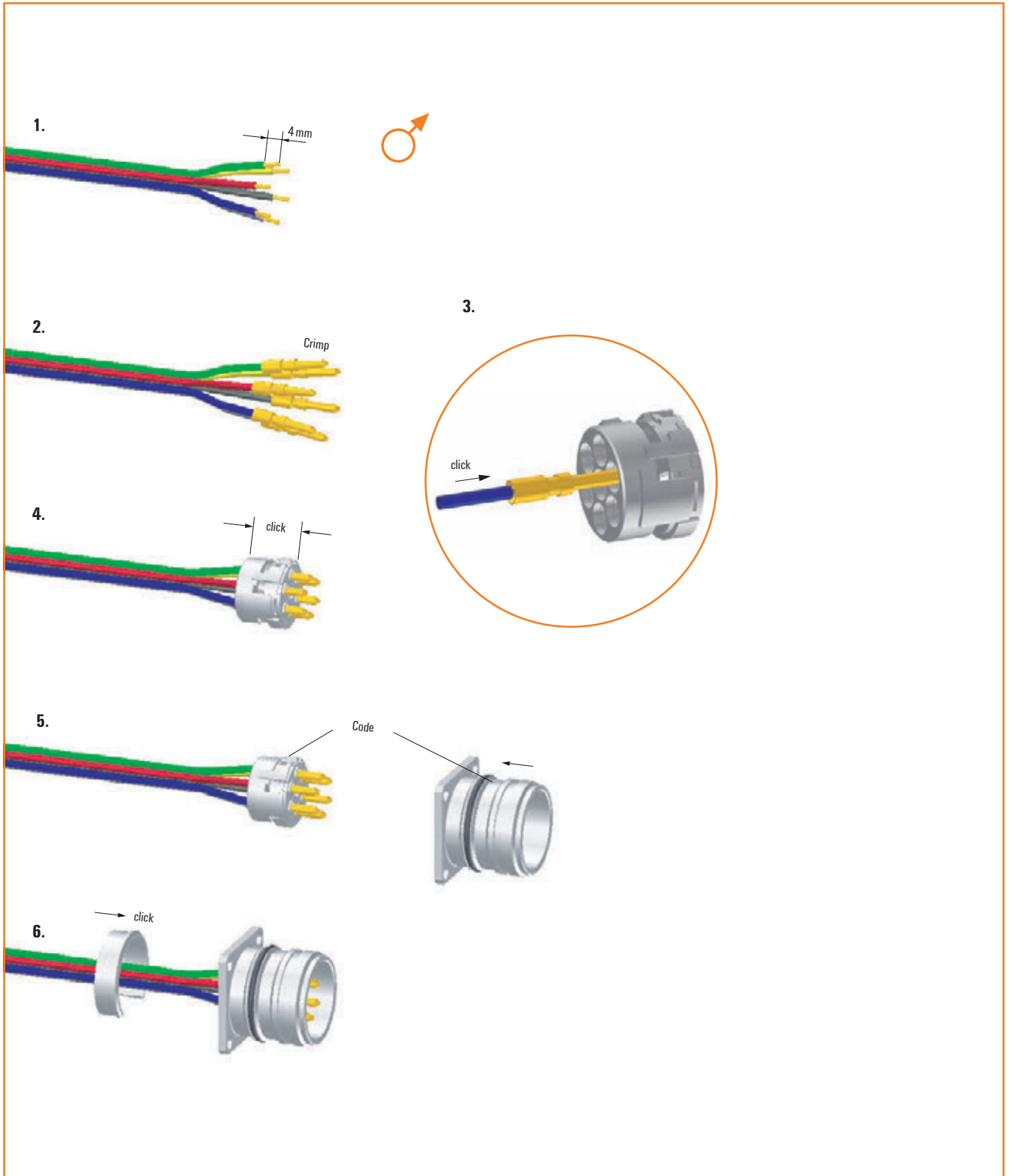

F

Mouser Electronics

Authorized Distributor

Click to View Pricing, Inventory, Delivery & Lifecycle Information:

[Weidmuller:](#)

[1169970000](#)