

General Specifications

Motor Protection: Auto Restart/Polarity Protection
 Insulation Resistance: 10M Ohm or over with a DC500V Megger
 Dielectric Withstand Voltage: AC 700V 1st
 Allowable Ambient Temperature Range:
 -10 degree C ~ +70 degree C (Operating)
 -40 degree C ~ +70 degree C (Storage)

Material

Casing: Plastic (Black) UL94V-0
 Impeller: Plastic (Black) UL94V-0
 Lead Wire: UL1007, AWG22, +Red, -Black

order part 17250VA-24Q-GA-00 IP69K Ball Bearing Fan DC Fans



DC Fans

17250VA characteristic curve

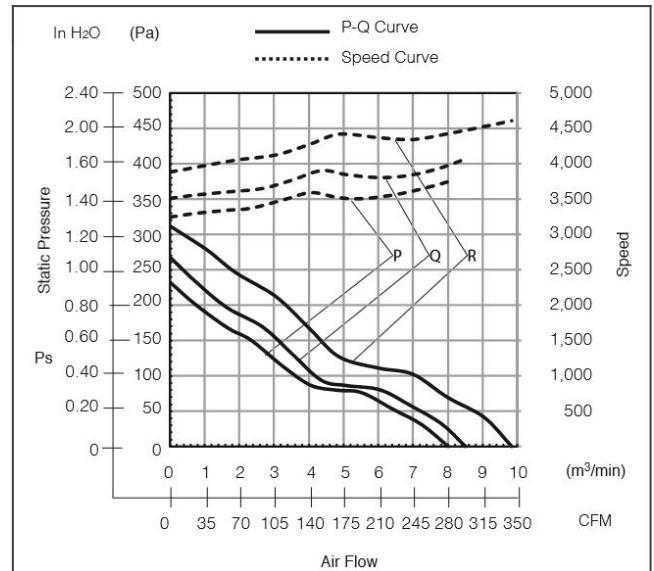

17250VA product drawing

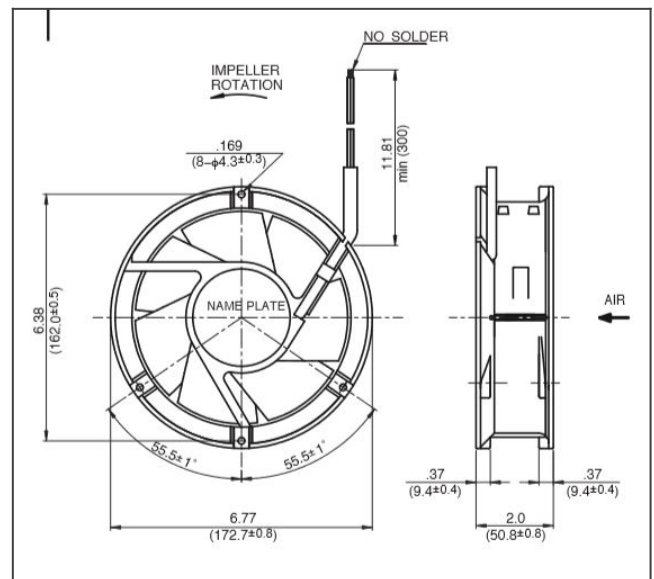

17250VA panel cut out

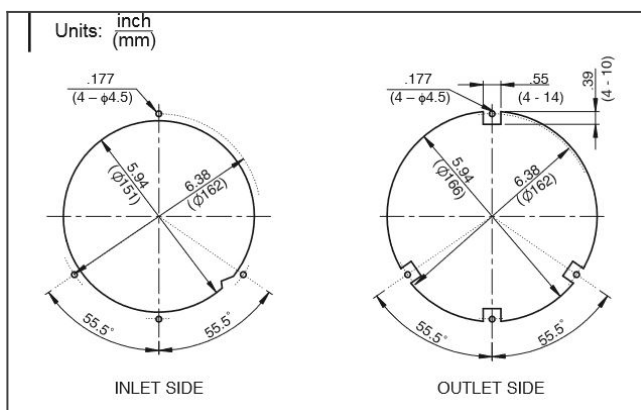

Detailed Specifications

DC Fans

Expected Life:	25 degree C 100,000 Hours (L10)
DC Fan:	IP69K Ball Bearing Fan
Nominal Voltage:	24[V]
Operating Voltage Lower:	18[V]
Operating Voltage Upper:	26.4[V]
Current:	1.3[A]
Input Power:	31.2[W]
Speed:	4000[min^{-1}]
Max. Air Flow:	8.5[m ³ /min]
Max. Air Flow:	300[CFM]
Max. Static Pressure:	267[Pa]
Max. Static Pressure:	1.07[In H ₂ O]
Noise:	58[dB]
Mass:	950[g]
Fan Size:	172[mm]
Fan Width:	50[mm]
Life Expectancy L10:	25 degree C 100,000 Hours (L10)
Series:	17250VA

Mouser Electronics

Authorized Distributor

Click to View Pricing, Inventory, Delivery & Lifecycle Information:

[NMB Technologies:](#)

[17250VA-24Q-GA-00](#)