

(1.27 mm) .050" PITCH • COST-EFFECTIVE HEADER/SOCKET

SFC	1	NO. PINS PER ROW	LEAD STYLE	PLATING OPTION	D	OPTIONS
		04, 05, 10, 15, 20, 25, 30, 35, 40, 45, 50 (Standard sizes)	-T1 = Through-hole Tiger Eye™ LITE -T2 = Surface Mount Tiger Eye™ LITE	-F = Gold flash on contact, Matte Tin on tail -L = 10 μ" (0.25 μm) Gold on contact, Matte Tin on tail		-A = Alignment Pin -K = (4.00 mm) .157" DIA Polyimide film Pick & Place Pad -TR = Tape & Reel (-T2 only) -FR = Full Reel Tape & Reel (must order max. quantity per reel; contact Samtec for quantity breaks) (-T2 only)

SFC
Board Mates:
TFC
Cable Mates:
TFS, TFSDT

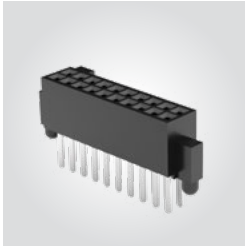

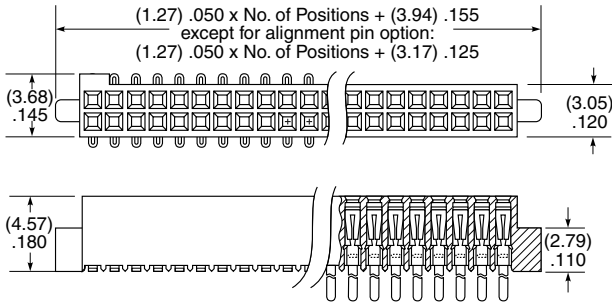

View complete specifications at: samtec.com?SFC

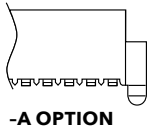
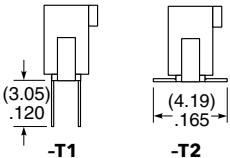
TFC	1	NO. PINS PER ROW	LEAD STYLE	PLATING OPTION	D	OPTIONS
		03, 04, 06, 08 (Lead Style -01 & -02 only) 05, 07, 10, 15, 20, 25, 30, 35, 40, 45, 50 (Standard sizes)	-X1 = Through-hole -X2 = Surface Mount	-F = Gold flash on post, Matte Tin on tail -L = 15 μ" (0.38 μm) Gold on post, Matte Tin on tail		-RA = Right-angle (-01 only) -A = Alignment Pin -LC = Locking Clip (Manual Placement required) (not available with -RA) -K = (6.75 mm) .266" DIA Polyimide film Pick & Place Pad (not available with -RA) -P = Plastic Pick & Place Pad (5 positions min.) (not available with -RA) -TR = Tape & Reel (-X2 only) (not available with -RA) -FR = Full Reel Tape & Reel (must order max. quantity per reel; contact Samtec for quantity breaks) (-X2 only) (not available with -RA)

TFC
Board Mates:
SFC
Cable Mates:
SFS, SFSDT



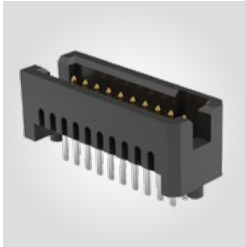

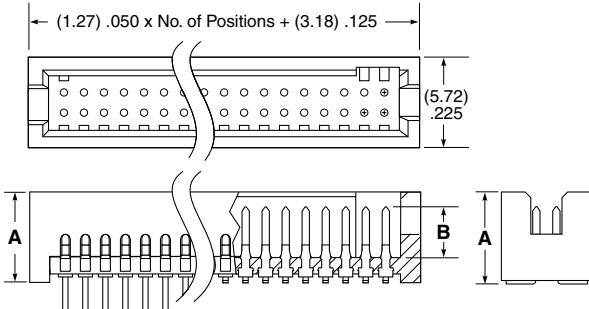
View complete specifications at: samtec.com?TFC

SMT LEAD STYLE	A	B	TH LEAD STYLE	A	B
-02	(5.72) .225	(3.38) .133	-01	(5.59) .220	(3.38) .133
-12	(7.49) .295		-11	(7.37) .290	
-22	(9.27) .365	(3.30) .130	-21	(9.14) .360	(3.30) .130
-32	(11.18) .440		-31	(11.05) .435	

Note:
Some lengths, styles and options are non-standard, non-returnable.

Mouser Electronics

Authorized Distributor

Click to View Pricing, Inventory, Delivery & Lifecycle Information:

[Samtec:](#)

[TFC-110-02-L-D-A](#)