

PRECISION BOARD STACKING STANDOFF

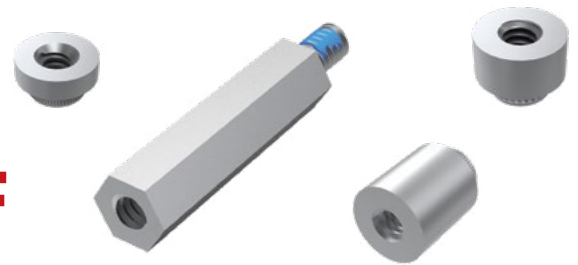

SO SERIES

SPECIFICATIONS

Material:
Aluminum
Locking Compound:
Nylon



Specify BOARD STACKER from chart

-01
= Female Thread/Press-In (-0515 thru -0865 only)

-02
= Male/Male Thread (-0515 and -1115 thru -2515 only)

-03
= Male/Female Thread (-0815 thru -2515 only)

-05
= Female/Female Thread (-1524 thru -2515 only)

-01
= #4-40 Thread
-02
= M3 x 0.5 Thread

-L
= -02 & -03 Lead Style thread locking compound (Leave blank for -01 Lead Style)

INDUSTRY STANDARD SOLUTIONS

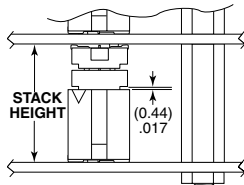

Requires Standoff
SO-1524-03-01-01-L or
JSOM-1524-02 for 15.24 mm
or SO-2215-02-01-01-L
for 22 mm board spacing.
Connectors designed to not
fully seat when mated.

For more information on the JSOM,
visit samtec.com?JSOM

INDUSTRY STANDARD	INTERCONNECTS			
	TERMINAL	SOCKET	BANKS	STACK HEIGHT
SUMIT™	ASP-129637-01	ASP-129646-01	1	15.24 mm
PCI/104-Express™	ASP-129637-03	ASP-129646-03	3	15.24 mm
PCI/104-Express™	ASP-129637-13	ASP-129646-22	1	15.24 mm
PCI/104-Express™	ASP-142781-01	ASP-129646-01	1	22 mm
PCI/104-Express™	ASP-142781-02	ASP-129646-02	2	22 mm
PCI/104-Express™	ASP-142781-03	ASP-129646-03	3	22 mm

BOARD STACKER	A	BOARD STACK HEIGHT
-0515	(5.15) .203	5 mm
-0715	(7.15) .282	7 mm
-0815	(8.15) .321	8 mm
-0865	(8.65) .341	8.5 mm
-1115	(11.15) .439	11 mm
-1215	(12.15) .478	12 mm
-1524	(15.24) .600	15.09 mm
-1615	(16.15) .636	16 mm
-1890	(18.90) .744	18.75 mm
-1915	(19.15) .754	19 mm
-2515	(25.15) .990	25 mm

ALSO AVAILABLE

MOQ Required

Other heights
Stainless Steel
Locking compound removed
Other materials and threading
No Hardware

Notes:
Standoffs are designed,
0.15 mm longer than
connector stack heights to
allow for processing variables.

Some sizes, styles and
options are non-standard,
non-returnable.

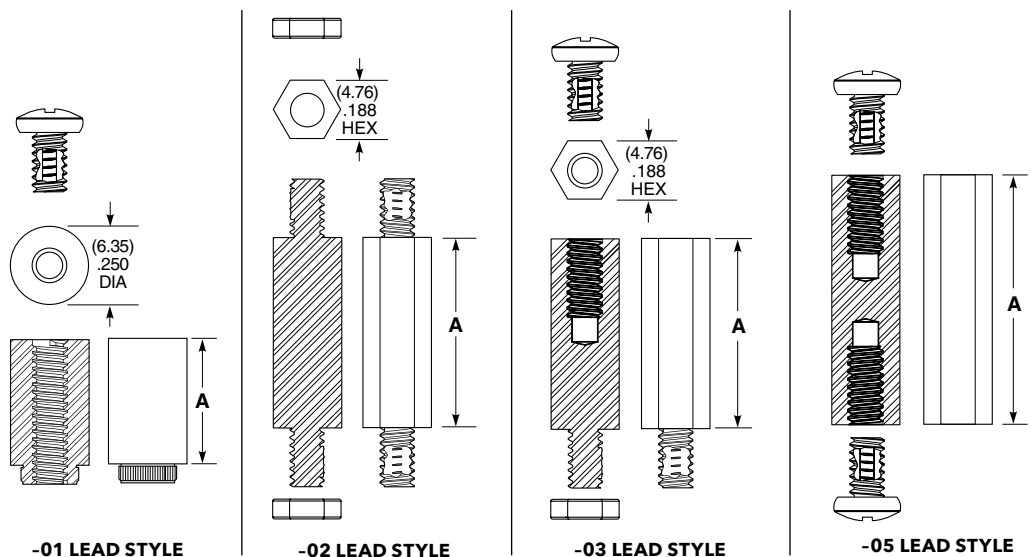

Components are to be packaged in separate bags unassembled.

Mouser Electronics

Authorized Distributor

Click to View Pricing, Inventory, Delivery & Lifecycle Information:

[Samtec:](#)

[SO-2200-03-01-02-N](#)