

TFML-1XX-XX-XXX-D-XX

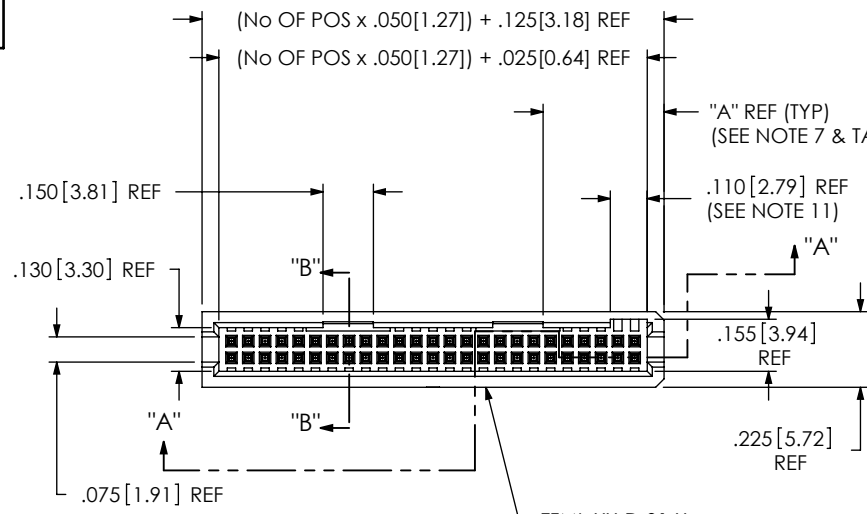

- No OF POSITIONS**  
-05,-07,-10 THRU -50 (PER ROW)
- LEAD STYLE**  
-01: THROUGH HOLE (SEE FIG. 1)  
-02: SURFACE MOUNT (SEE FIG.3, SHT 2)
- PLATING SPECIFICATION**  
-S: SELECTIVE (USE T-1R16-XX-S-X)  
-L: LIGHT SELECTIVE (USE T-1R16-XX-L-X)  
-F: FLASH GOLD (USE T-1R16-XX-F-X)  
-P: GOLD FLASH PALLADIUM NICKEL (USE T-1R16-XX-P-X)  
-H: HEAVY GOLD (USE T-1R16-XX-H-X)  
-FM: SELECTIVE FLASH GOLD, MATTE TIN TAIL (USE T-1R16-XX-F-X)  
-LM: SELECTIVE LIGHT GOLD, MATTE TIN TAIL (USE T-1R16-XX-L-X)  
-SM: SELECTIVE HEAVY GOLD, MATTE TIN TAIL (USE T-1R16-XX-S-X)  
-STL: SELECTIVE TIN LEAD (USE T-1R16-XX-STL-X)
- OPTION**  
-A: ALIGNMENT PIN (USE TFML-XX-D-01-A) (SEE FIG. 7, SHT 3)  
-LC: LOCKING CLIP (USE LC-05-TM) (SEE FIG. 9, SHT 3, N/A ON -RA OPTION)  
-P: PICK & PLACE PAD (USE PPP-04) (AVAIL IN ALL POSITIONS, N/A ON -RA OPTION, SEE FIG. 5, SHT 2)  
-RA: RIGHT ANGLE (LEAD STYLE -01 ONLY) (SEE FIG. 4, SHT 2)  
-TR: TAPE & REEL (SEE FIG. 2)  
-SA: STAKED ALIGNMENT PIN (USE SM-A5) (SEE FIG. 8, SHT 3)  
-K: POLYAMIDE FILM (USE K-500-300) (SEE FIG. 6, SHT 2) (N/A ON -RA)  
-SN: SOLDER NAIL (USE TFML-XX-D-01-SN & WT-27-01-T) (SEE FIG. 10, SHEET 4) (AVAILABLE ON -02 LEAD STYLE ONLY)
- ROW SPECIFICATION**  
-D: DOUBLE ROW

FIG. 1  
-01: THROUGH HOLE

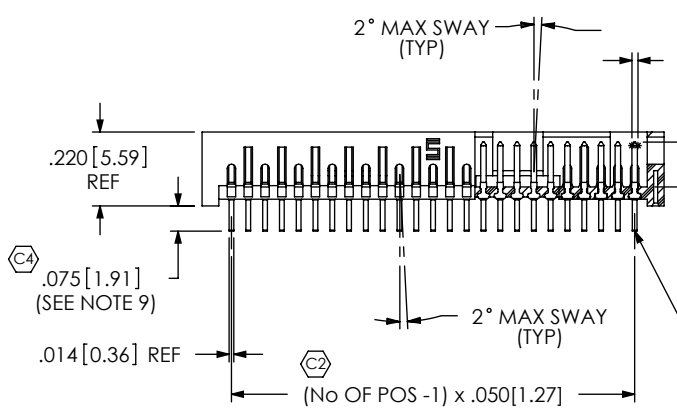

SECTION "A"-"A"

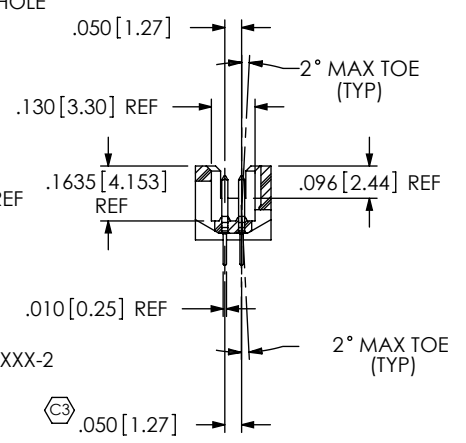

SECTION "B"-"B"

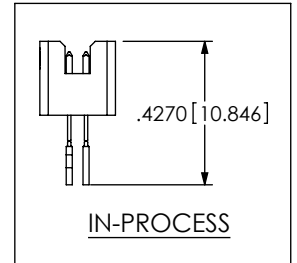

NOTES:

- Ⓞ REPRESENTS A CRITICAL DIMENSION.
- COPLANARITY: POSITIONS -10 THRU -26: .004[0.10] POSITIONS -27 THRU -50: .006[0.15].
- MANUFACTURING IN-PROCESS DIMENSION DESIGNED TO ACHIEVE FINISHED ASSEMBLY.
- MINIMUM PUSHOUT FORCE: 1.0 LB [4.4 N].
- MAXIMUM ALLOWABLE BOW: .004 INCH/INCH [0.10 MM/MM] AFTER ASSEMBLY.
- MEASURED FROM BEND.
- POSITIONS -05 AND -07 WILL ONLY HAVE ONE CLIP AT DIMENSION SHOWN; POSITIONS -10 THROUGH -24 WILL HAVE ONLY ONE CLIP AT DIMENSION SHOWN; POSITIONS -25 THROUGH -34 WILL HAVE TWO CLIPS AT DIMENSION SHOWN; POSITIONS -35 THROUGH -50 WILL HAVE THREE CLIPS: TWO AT DIMENSION SHOWN & ONE CENTERED ON INSULATOR.
- NOTE DELETED.
- .003[0.08] MAXIMUM TERMINAL BURR
- .005[0.13] MAXIMUM HEIGHT VARIATION BETWEEN ANY TWO PINS.
- DIMENSION IS NOT APPLICABLE FOR -05 AND -07 POSITION.

| NO OF POS.              | "A"  |
|-------------------------|------|
| EVEN                    | .310 |
| ODD (EXCL. -05,-07 POS) | .360 |
| -05,-07                 | .113 |

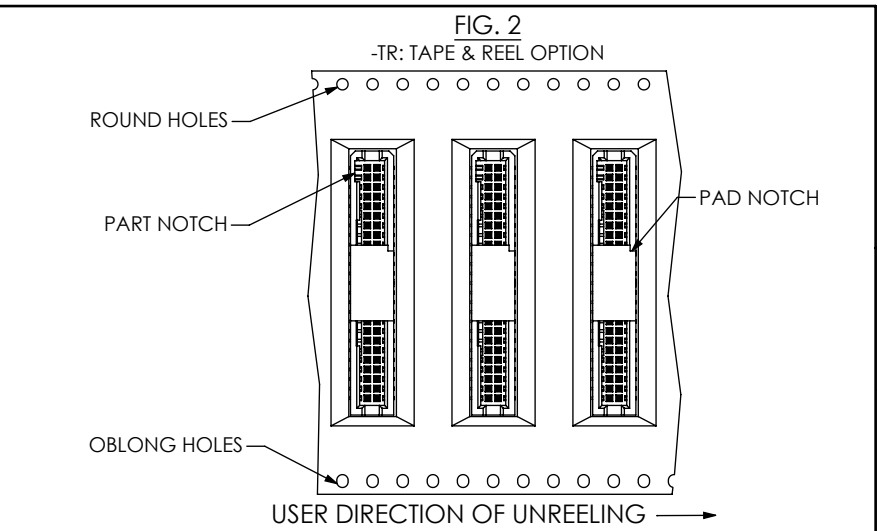

UNLESS OTHERWISE SPECIFIED, DIMENSIONS ARE IN INCHES. TOLERANCES ARE:  
DECIMALS .XX: ±.01 .XXX: ±.005 .XXXX: ±.0020  
ANGLES 2°

**PROPRIETARY NOTE**  
THIS DOCUMENT CONTAINS INFORMATION CONFIDENTIAL AND PROPRIETARY TO SAMTEC, INC. AND SHALL NOT BE REPRODUCED OR TRANSFERRED TO OTHER DOCUMENTS OR DISCLOSED TO OTHERS OR USED FOR ANY PURPOSE OTHER THAN THAT WHICH IT WAS OBTAINED WITHOUT THE EXPRESSED WRITTEN CONSENT OF SAMTEC, INC.

**samtec**  
520 PARK EAST BLVD, NEW ALBANY, IN 47150  
PHONE: 812-944-6733 FAX: 812-948-5047  
e-Mail: info@SAMTEC.com code: 53322

**MATERIAL:**  
VETRA E130I, COLOR: BLACK  
CONTACT: PHOS BRONZE, THICKNESS: .018

DO NOT SCALE DRAWING SHEET SCALE: 1:75:1

**DESCRIPTION:**  
.050 SHROUDED TERMINAL ASSEMBLY

**DWG. NO.**  
TFML-1XX-XX-XXX-D-XX

**BY:** DEANP 4/8/99 **SHEET 1 OF 4**

FIG. 3

-02: SURFACE MOUNT  
(SHOWN: TFML-125-02-XXX-D)  
(SAME AS FIG. 1, UNLESS OTHERWISE STATED)

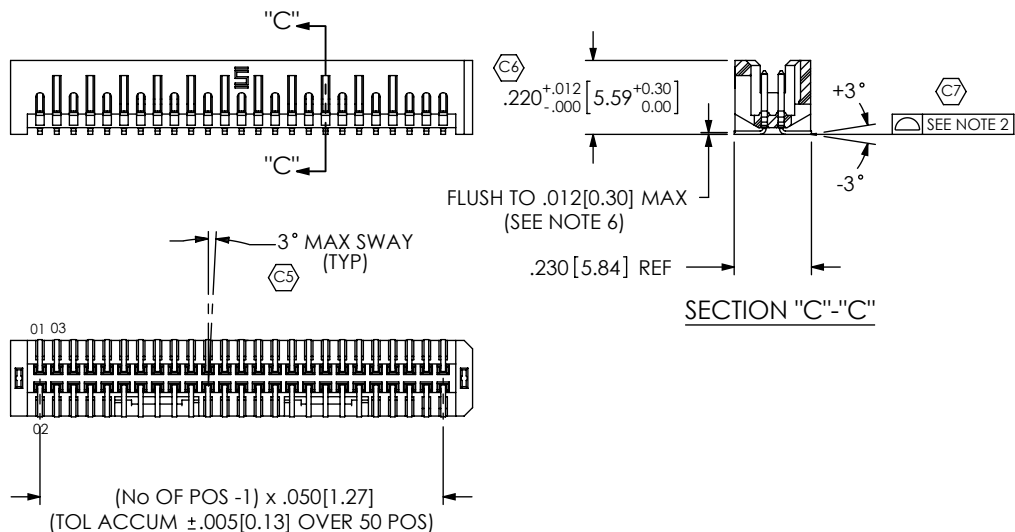

FIG. 5

-P: PICK & PLACE PAD OPTION  
(SHOWN: TFML-125-02-XXX-D-P)  
(SAME AS FIG. 1, UNLESS OTHERWISE STATED)  
NOTCH ON PAD TO BE ON SAME END AS NOTCH IN TFM BODY

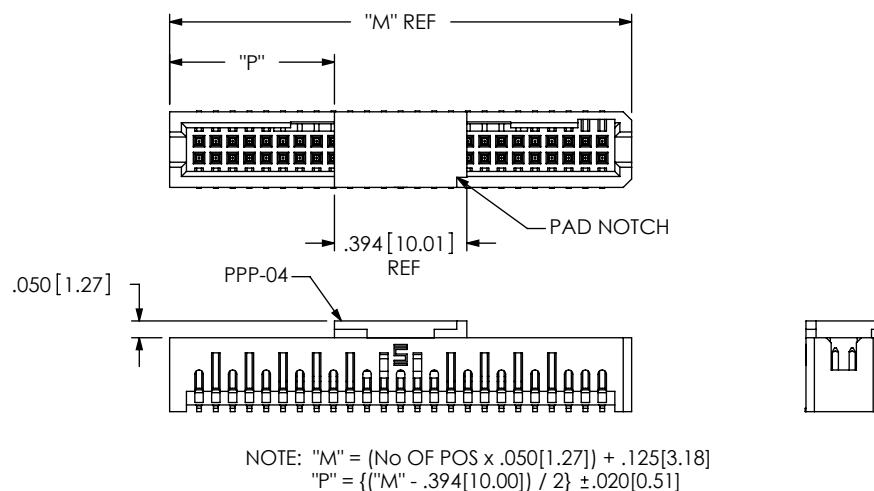

FIG. 4

-RA: RIGHT ANGLE OPTION  
(SHOWN: TFML-125-01-XXX-D-RA)  
(SAME AS FIG. 1, UNLESS OTHERWISE STATED)

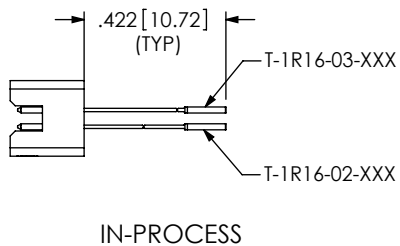
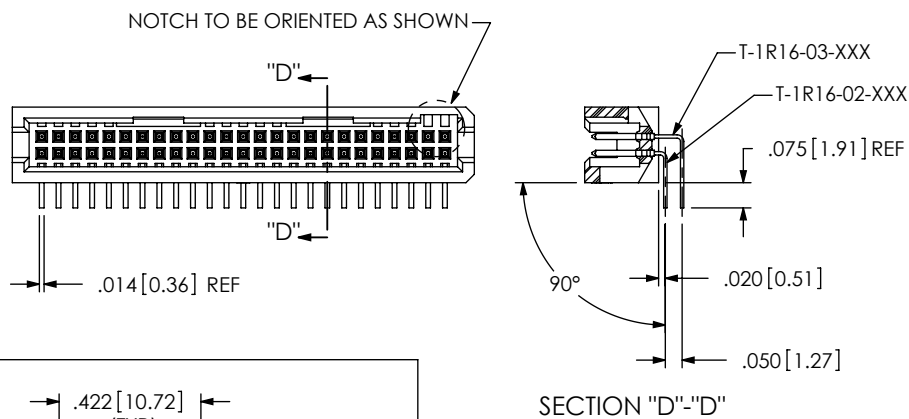
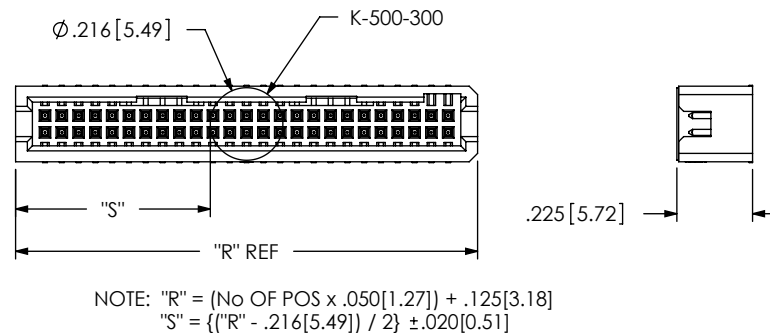

FIG. 6

-K: POLYAMIDE FILM PAD OPTION  
(SHOWN: TFML-125-02-XXX-D-K)  
(SAME AS FIG. 1, UNLESS OTHERWISE STATED)



F:\DWG\MISC\MKTG\TFML-1XX-XX-XXX-D-XX-MKT.SLDDRW

PROPRIETARY NOTE

THIS DOCUMENT CONTAINS INFORMATION CONFIDENTIAL AND PROPRIETARY TO SAMTEC, INC. AND SHALL NOT BE REPRODUCED OR TRANSFERRED TO OTHER DOCUMENTS OR DISCLOSED TO OTHERS OR USED FOR ANY PURPOSE OTHER THAN THAT WHICH IT WAS OBTAINED WITHOUT THE EXPRESSED WRITTEN CONSENT OF SAMTEC, INC.

DO NOT SCALE DRAWING

SHEET SCALE: 1:75:1



520 PARK EAST BLVD, NEW ALBANY, IN 47150  
PHONE: 812-944-6733 FAX: 812-948-5047  
e-Mail: info@SAMTEC.com code: 53322

DESCRIPTION:  
.050 SHROUDED TERMINAL ASSEMBLY

DWG. NO.  
TFML-1XX-XX-XXX-D-XX

BY: DEANP 4/8/99 SHEET 2 OF 4

PACKAGING VIEWS

PARTS TO BE POSITIONED WITH POLARIZING NOTCH FACING THE SAMTEC LOGO AND ARROW.

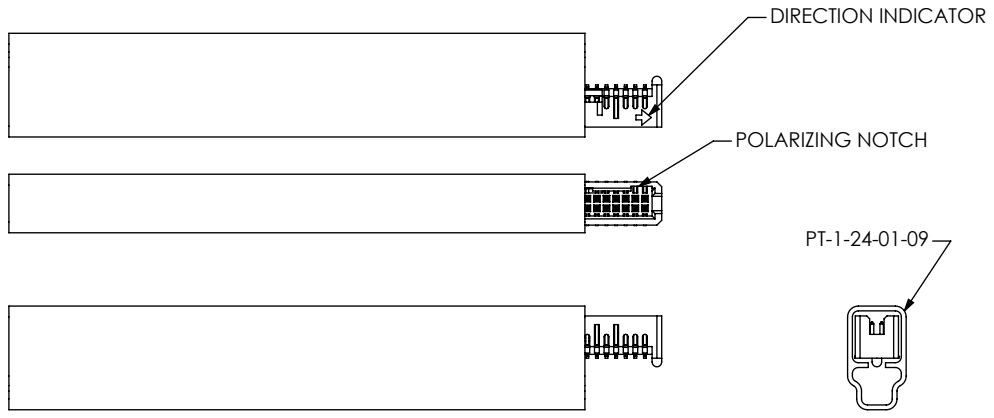

PARTS TO BE POSITIONED WITH TAILS FACING LOGO SIDE OF TUBE AND POLARIZING NOTCH ORIENTED AS SHOWN

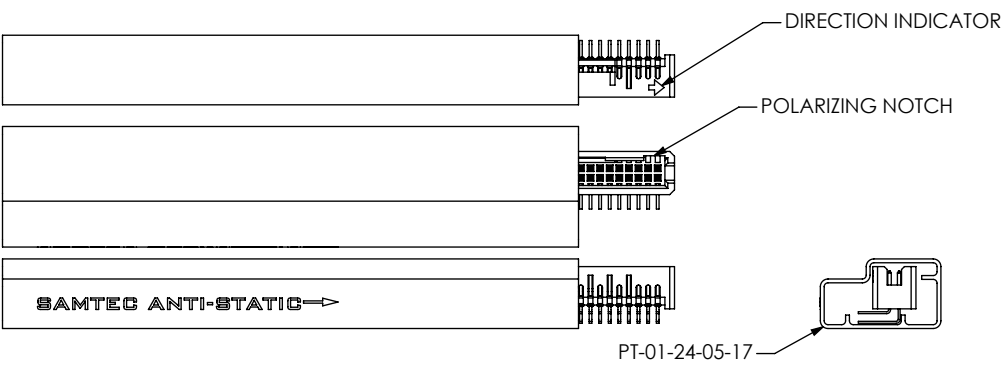

POSITION PARTS WITH POLARIZING NOTCH ORIENTED AS SHOWN

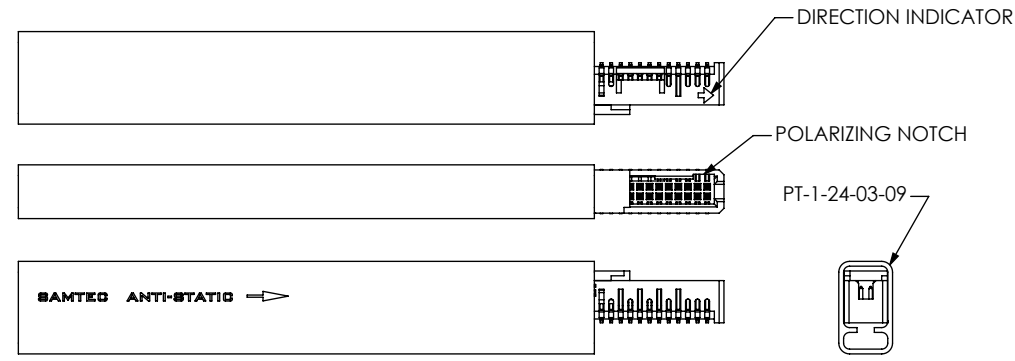

| LEAD STYLE               | PACKAGING TUBE | PLUG  |
|--------------------------|----------------|-------|
| -RA ONLY                 | PT-1-24-05-17  | TP-07 |
| -01,-02 EXCEPT -RA OR -P | PT-1-24-01-09  | TP-24 |
| -01-P,-02-P              | PT-1-24-03-09  | TP-03 |

FIG. 7

-A: ALIGNMENT PIN OPTION (SHOWN: TFML-125-02-XXX-D-A) (SAME AS FIG. 1, UNLESS OTHERWISE STATED) -NOT AVAILABLE WITH -RA

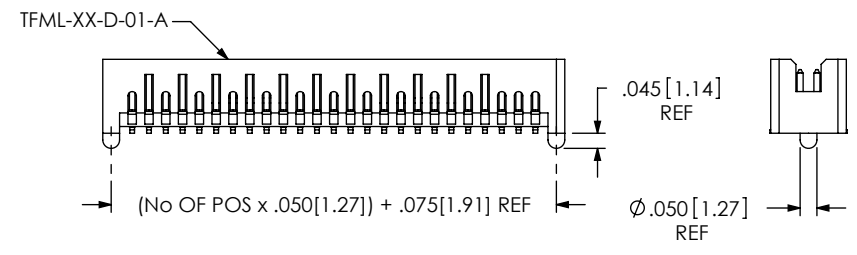

FIG. 8

-SA: STAKED ALIGNMENT PIN OPTION (SHOWN: TFML-125-02-XXX-D-SA) (SAME AS FIG. 1, UNLESS OTHERWISE STATED) -NOT AVAILABLE ON -RA

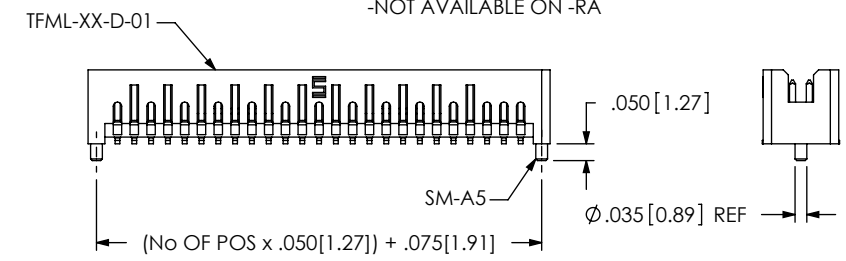
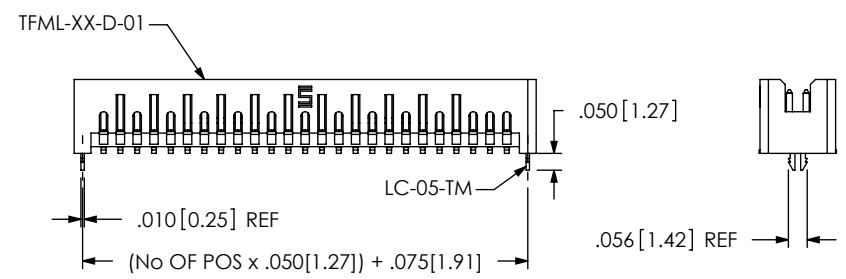

FIG. 9

-LC: LOCKING CLIP OPTION (SHOWN: TFML-125-02-XXX-D-LC) (SAME AS FIG. 1, UNLESS OTHERWISE STATED) -NOT AVAILABLE ON -RA



F:\DWG\MISC\MKTG\TFML-1XX-XX-XXX-D-XX-MKT.SLDDRW

**PROPRIETARY NOTE**  
THIS DOCUMENT CONTAINS INFORMATION CONFIDENTIAL AND PROPRIETARY TO SAMTEC, INC. AND SHALL NOT BE REPRODUCED OR TRANSFERRED TO OTHER DOCUMENTS OR DISCLOSED TO OTHERS OR USED FOR ANY PURPOSE OTHER THAN THAT WHICH IT WAS OBTAINED WITHOUT THE EXPRESSED WRITTEN CONSENT OF SAMTEC, INC.



520 PARK EAST BLVD, NEW ALBANY, IN 47150  
PHONE: 812-944-6733 FAX: 812-948-5047  
e-Mail: info@SAMTEC.com code: 53322

DO NOT SCALE DRAWING

SHEET SCALE: 1:75:1

DESCRIPTION:  
.050 SHROUDED TERMINAL ASSEMBLY

DWG. NO.  
**TFML-1XX-XX-XXX-D-XX**

BY: DEANP 4/8/99 SHEET 3 OF 4

**FIG. 10**  
 -SN: SOLDER PIN OPTION  
 (SHOWN: TFML-125-02-XXX-D-SN)  
 (SAME AS FIG. 1, UNLESS OTHERWISE STATED)  
 (ONLY AVAILABLE ON -02 LEAD STYLE)

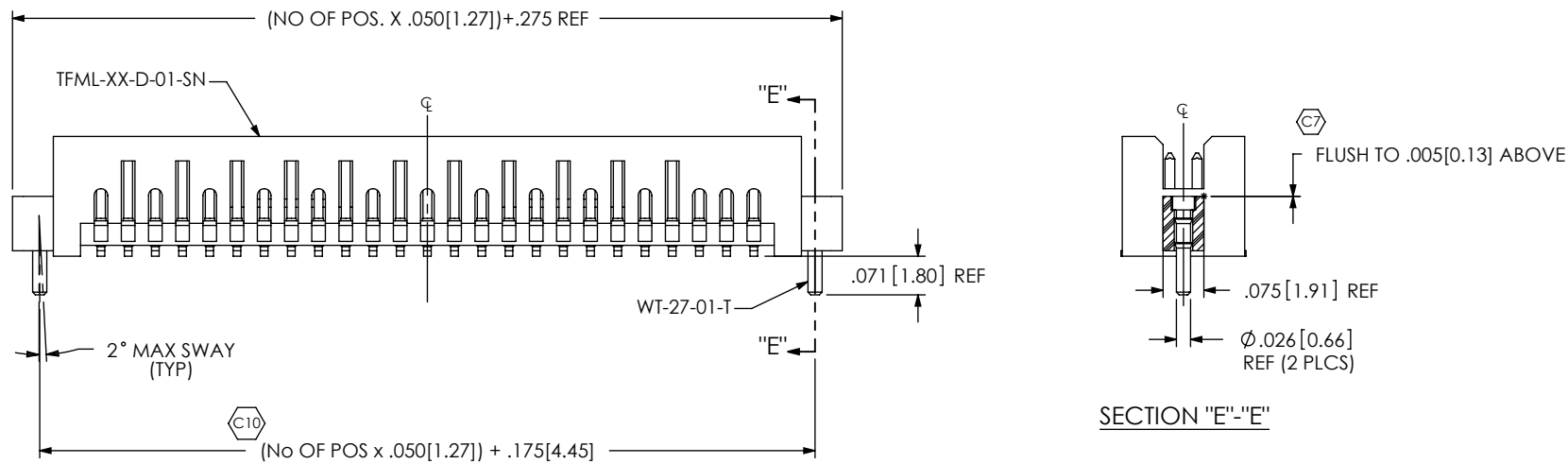

**PROPRIETARY NOTE**  
 THIS DOCUMENT CONTAINS INFORMATION  
 CONFIDENTIAL AND PROPRIETARY TO  
 SAMTEC, INC. AND SHALL NOT BE REPRODUCED  
 OR TRANSFERRED TO OTHER DOCUMENTS OR  
 DISCLOSED TO OTHERS OR USED FOR ANY  
 PURPOSE OTHER THAN THAT WHICH IT WAS  
 OBTAINED WITHOUT THE EXPRESSED WRITTEN  
 CONSENT OF SAMTEC, INC.

DO NOT SCALE DRAWING

SHEET SCALE: 3:1

|   |        |
|---|--------|
| <br>520 PARK EAST BLVD, NEW ALBANY, IN 47150<br>PHONE: 812-944-6733 FAX: 812-948-5047<br>e-Mail: info@SAMTEC.com code: 55322 |        |
| DESCRIPTION:<br>.050 SHROUDED TERMINAL ASSEMBLY   |        |
| DWG. NO.<br>TFML-1XX-XX-XXX-D-XX  |        |
| BY: DEANP   | 4/8/99 |
| SHEET 4 OF 4  |        |

# Mouser Electronics

Authorized Distributor

Click to View Pricing, Inventory, Delivery & Lifecycle Information:

[Samtec:](#)

[TFML-105-01-F-D-RA](#) [TFML-110-01-F-D-A](#) [TFML-110-01-F-D-LC](#)