

FLAT FLEXIBLE CABLE (FCC) JUMPER & SOCKET

(1.00 mm) .0394" PITCH • FJ/ZF1/FC1 SERIES

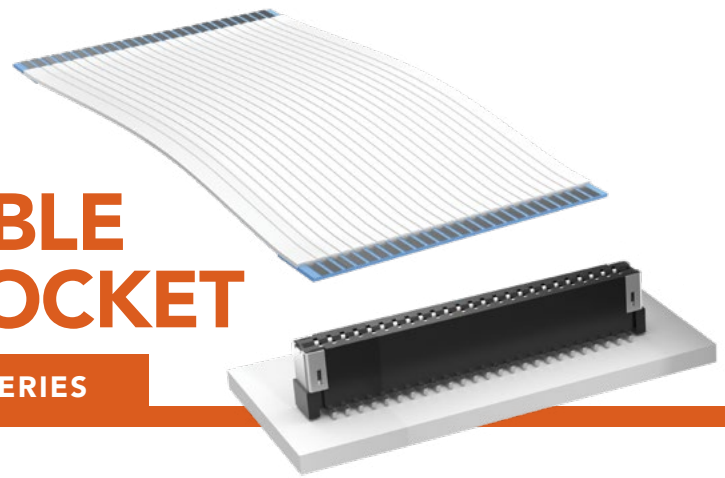

FJ

Mates:
FC1, ZF1

ZF1/FC1

Mates:
FJ

SPECIFICATIONS

FJ

Conductor:
Tin Plated Copper
Conductor Resistance:
300 Ω/km max
Insulation Resistance:
10 MΩ/km min
(conductor-to-conductor)
Dielectric Test:
400 VAC during 1 minute
(conductor-to-conductor)
Temperature Rating:
-30 °C to +80 °C
Voltage Rating:
300 VAC

ZF1

Insulator Material:
Liquid Crystal Polymer
Contact Material:
Phosphor Bronze
Plating:
Sn over 40 μ" (1.02 μm) Ni
Weld Tab: Phosphor Bronze
Operating Temp Range:
-55 °C to +105 °C

FC1

Insulator Material:
Liquid Crystal Polymer
Contact Material:
Phosphor Bronze
Plating:
Sn over 50 μ" (1.27 μm) Ni
Operating Temp Range:
-55 °C to +105 °C
Max Cycles:
25 with FJ

PROCESSING

ZF1/FC1

Lead-Free Solderable:
Yes
SMT Lead Coplanarity:
(0.10 mm) .004" max

Notes:
FJ Stiffener color will be blue or black at Samtec's discretion.

Some sizes, styles and options are non-standard, non-returnable.

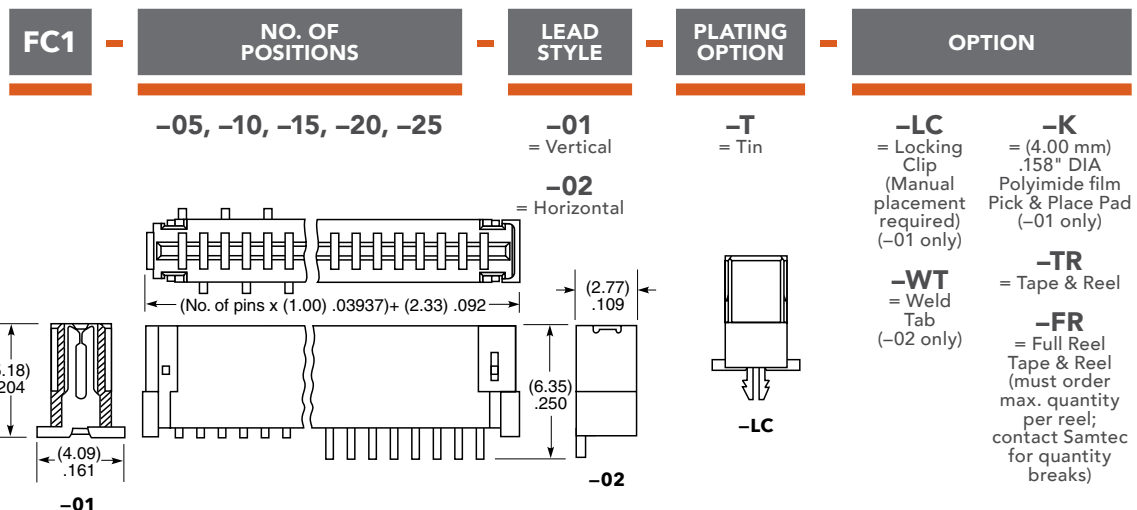
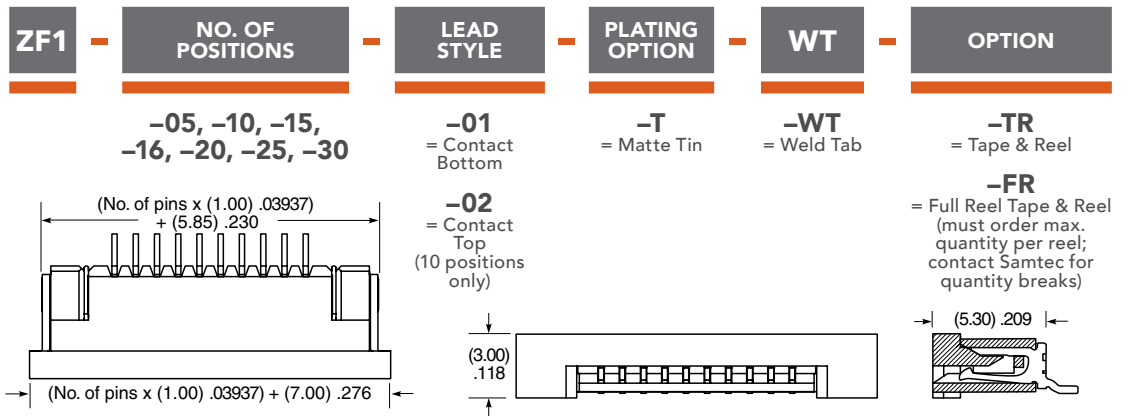
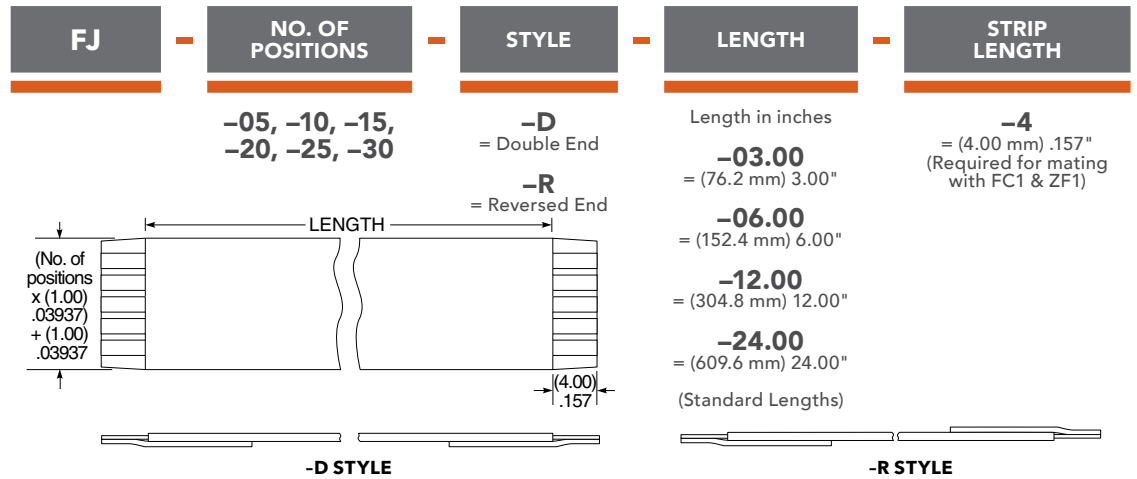

Mouser Electronics

Authorized Distributor

Click to View Pricing, Inventory, Delivery & Lifecycle Information:

[Samtec:](#)

[FJ-15-R-25.00-4](#)