

DO NOT SCALE FROM THIS PRINT

TABLE 1		
LEAD STYLE	"A"	"B"
-02	.075 [1.91] $\text{\textcircled{C}}$	0.075
-03	.065 [1.65] $\text{\textcircled{C}}$	0.055

No OF POS PER ROW  
-02 THRU -50  
(SEE NOTE 10)

LEAD STYLE  
-02: .075 [1.91]  
(USE T-1S16-03-XX-2)  
-03: .065 [1.65]  
(USE T-1S16-04-XX-2)

OPTIONS  
-P: PICK & PLACE PAD (USE PPP-30)  
(USE PPP-30-NT FOR TAPE & REEL)  
(SEE FIG 3, SHT 4; 6 POS MIN)

-TR: TAPE & REEL PACKAGING

-ES: SNAP ON END SHROUDS  
(SEE FIG 2, SHT 2; 9 POS MIN)  
MOLD TO POSITION END SHROUDS  
(5 POS MIN; SEE FIG 2, SHT 2)  
(SAMTEC DISCRETION ON WHICH END SHROUDS ARE USED FOR POSITIONS -09 AND GREATER)

-EP: GUIDE POST (SEE FIG 4, SHT 4; 9 POS MIN)  
(USE ONLY WHEN MATING WITH A CLM)

-EC: LOCKING CLIP (SEE FIG 5, SHT 4)  
(SEE NOTE 9; 9 POS MIN)

-A: ALIGNMENT PIN (SEE FIG 6 & 7, SHT 5)  
(SAMTEC DISCRETION ON WHICH -A PIN IS USED)  
(MOLDED: 3 POS MIN, USE FTMH-75-D-XX)  
(STAKED: 7 POS MIN, USE FTMH-60-D)

ROW SPECIFICATION  
-DV: DOUBLE ROW VERTICAL  
(USE FTMH-75-D)

PLATING SPECIFICATION  
-L: 10 $\mu$ " LIGHT SELECTIVE GOLD IN CONTACT AREA, MATTE TIN ON TAIL  
-F: 3 $\mu$ " FLASH SELECTIVE GOLD IN CONTACT AREA, MATTE TIN ON TAIL  
-H: 30 $\mu$ " HEAVY GOLD IN CONTACT AREA, 3 $\mu$ " FLASH GOLD ON TAIL  
-G: 10 $\mu$ " GOLD IN CONTACT AREA, 3 $\mu$ " FLASH GOLD ON TAIL  
-LM: 10 $\mu$ " LIGHT SELECTIVE GOLD IN CONTACT AREA, MATTE TIN ON TAIL  
-FM: 3 $\mu$ " FLASH SELECTIVE GOLD IN CONTACT AREA, MATTE TIN ON TAIL

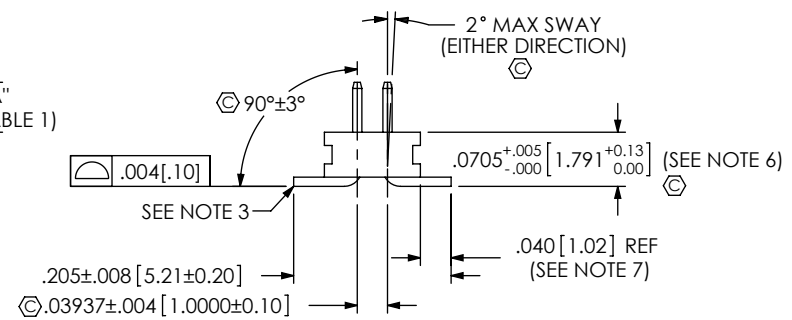
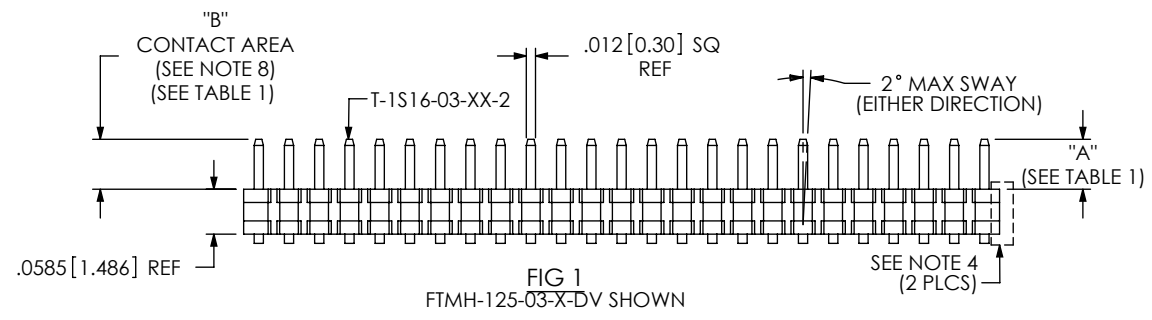
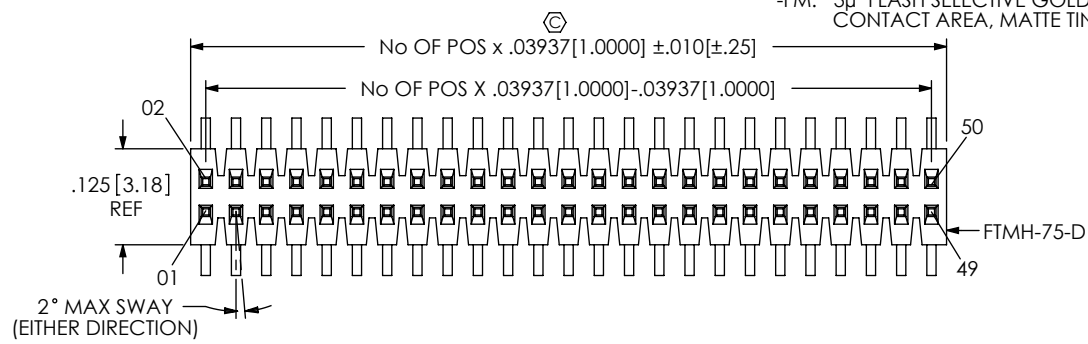

NOTES:

1.  $\text{\textcircled{C}}$  REPRESENTS CRITICAL DIMENSION.
2. MIN PUSHOUT FORCE: 1.0 LB = 16 OZ.
3. MAX BURR: .003 [0.08].
4. MAX CUT FLASH: .010 [0.25].
5. POSITIONS -02 THRU -04 TO BE LAYER PACKAGED.
6. MEASURED AT BEND RADIUS.
7. SHEAR TAILS TO DIMENSION SHOWN.
8. FOR SELECTIVE PLATING OPTIONS, GOLD PLATING TO BE ON POST, TIN PLATING TO BE ON TAIL.
9. DUE TO THE HIGH AMOUNT OF INSERTION FORCE NEEDED, THE -EC OPTION IS NOT COMPATIBLE WITH AUTO PLACEMENT. SAMTEC RECOMMENDS MANUAL PLACEMENT FOR ALL ASSEMBLIES WITH THE -EC OPTION.
10. NUMBER OF POSITIONS MAY BE AS HIGH AS -75 FOR SAMTEC MANUFACTURING ONLY.

UNLESS OTHERWISE SPECIFIED, DIMENSIONS ARE IN INCHES. TOLERANCES ARE: DECIMALS ANGLES .XX: ±.01 [.3] .XXX: ±.005 [.13] .XXXX: ±.0010 [.025]	PROPRIETARY NOTE THIS DOCUMENT CONTAINS INFORMATION CONFIDENTIAL AND PROPRIETARY TO SAMTEC, INC. AND SHALL NOT BE REPRODUCED OR TRANSFERRED TO OTHER DOCUMENTS OR DISCLOSED TO OTHERS OR USED FOR ANY PURPOSE OTHER THAN THAT WHICH IT WAS OBTAINED WITHOUT THE EXPRESSED WRITTEN CONSENT OF SAMTEC, INC.		
		520 PARK EAST BLVD, NEW ALBANY, IN 47150 PHONE: 812-944-6733 FAX: 812-948-5047 e-Mail: info@SAMTEC.com code: 5332	
MATERIAL	DO NOT SCALE DRAWING	SHEET SCALE: 5:1	DESCRIPTION:
INSULATOR: BLACK, LCP, UL-94-V-0			1mm x 1mm DOUBLE VERTICAL SMT TERMINAL STRIP
TERMINAL: PHOSPHOR BRONZE			DWG. NO. <b>FTMH-1XX-XX-XX-DV-XX</b>
BY: PURVIS		04-22-96	SHEET 1 OF 5

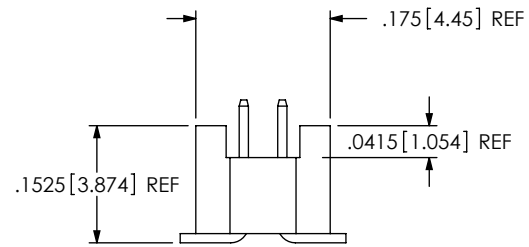
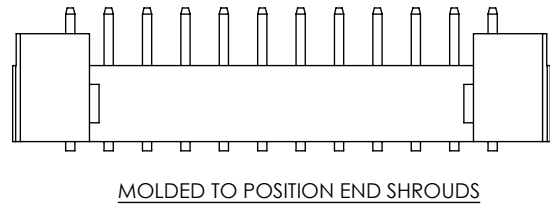
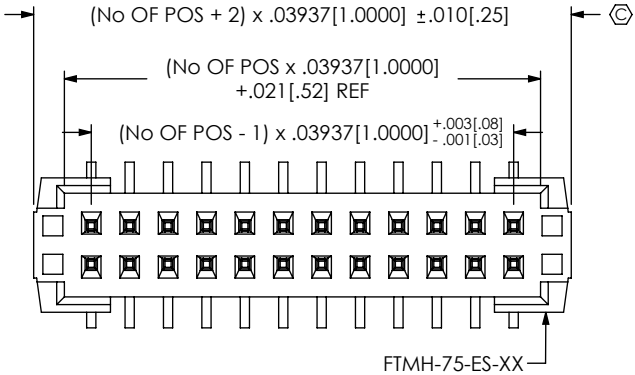
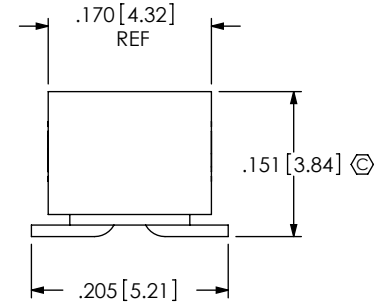
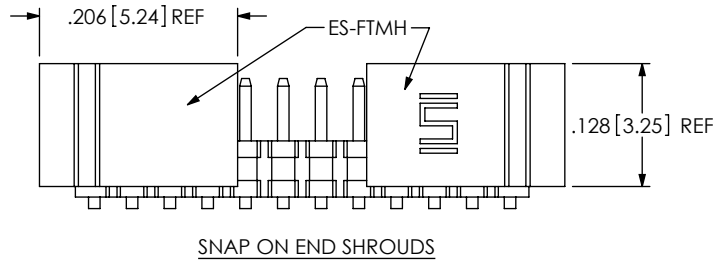
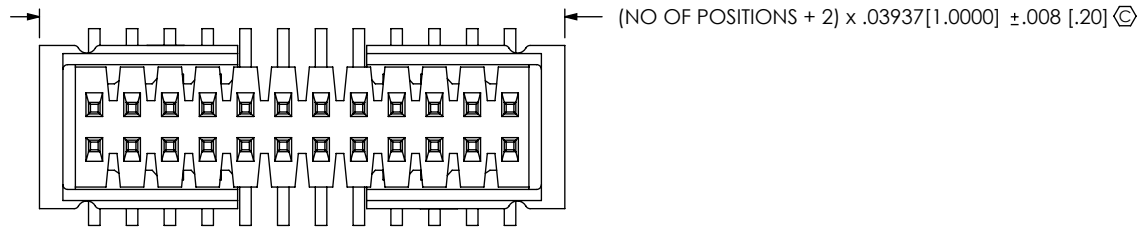

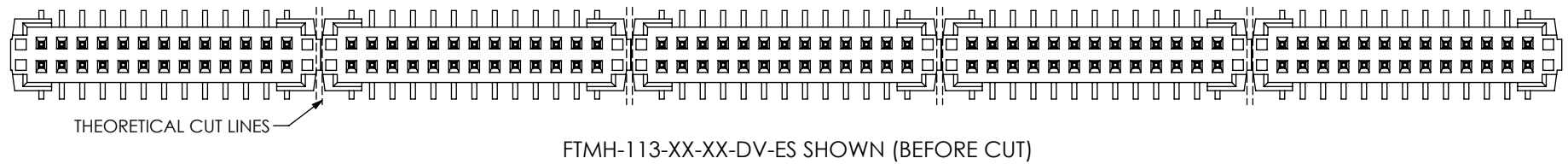
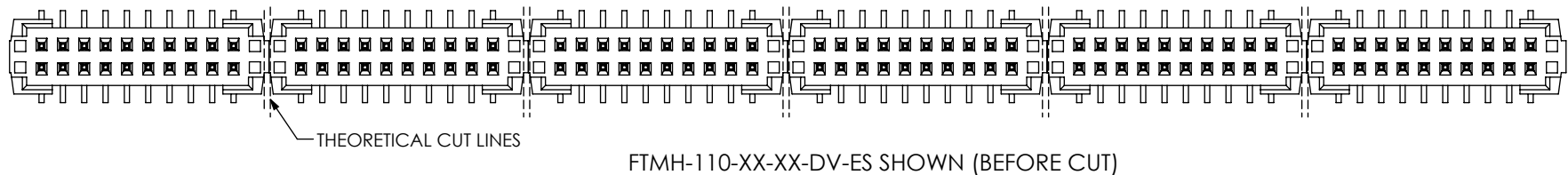
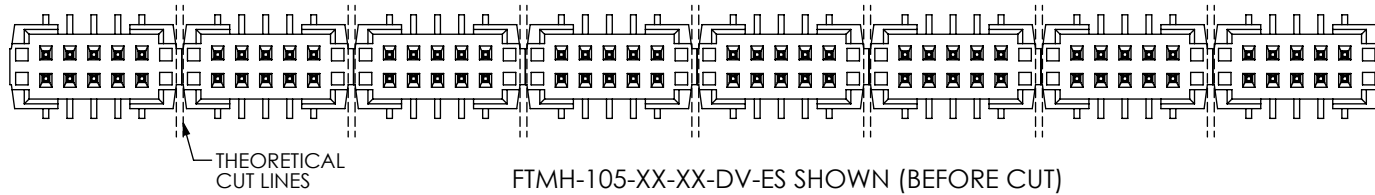

FIG 2  
-ES: END SHROUDS  
FTMH-112-02-X-DV-ES SHOWN  
(DIFFERENT AS SHOWN, OTHERWISE SAME AS FIG 1)

<p>PROPRIETARY NOTE</p> <p>THIS DOCUMENT CONTAINS INFORMATION CONFIDENTIAL AND PROPRIETARY TO SAMTEC, INC. AND SHALL NOT BE REPRODUCED OR TRANSFERRED TO OTHER DOCUMENTS OR DISCLOSED TO OTHERS OR USED FOR ANY PURPOSE OTHER THAN THAT WHICH IT WAS OBTAINED WITHOUT THE EXPRESSED WRITTEN CONSENT OF SAMTEC, INC.</p> <p>DO NOT SCALE DRAWING</p> <p>SHEET SCALE: 5:1</p>		
	<p>520 PARK EAST BLVD, NEW ALBANY, IN 47150 PHONE: 812-944-6733 FAX: 812-948-5047 e-Mail: info@SAMTEC.com code: 55322</p>	
	<p>DESCRIPTION: 1mm x 1mm DOUBLE VERTICAL SMT TERMINAL STRIP</p>	
	<p>DWG. NO. <b>FTMH-1XX-XX-XX-DV-XX</b></p>	
<p>BY: PURVIS</p>	<p>04-22-96</p>	<p>SHEET 2 OF 5</p>



**PROPRIETARY NOTE**  
THIS DOCUMENT CONTAINS INFORMATION  
CONFIDENTIAL AND PROPRIETARY TO  
SAMTEC, INC. AND SHALL NOT BE REPRODUCED  
OR TRANSFERRED TO OTHER DOCUMENTS OR  
DISCLOSED TO OTHERS OR USED FOR ANY  
PURPOSE OTHER THAN THAT WHICH IT WAS  
OBTAINED WITHOUT THE EXPRESSED WRITTEN  
CONSENT OF SAMTEC, INC.

DO NOT SCALE DRAWING  
SHEET SCALE: 5:1

**samtec**  
520 PARK EAST BLVD, NEW ALBANY, IN 47150  
PHONE: 812-944-6733 FAX: 812-948-5047  
e-Mail: info@SAMTEC.com code: 55322

DESCRIPTION:  
1mm x 1mm DOUBLE VERTICAL SMT TERMINAL STRIP

DWG. NO.  
FTMH-1XX-XX-XX-DV-XX

BY: PURVIS 04-22-96 SHEET 3 OF 5

NOTE  
 "M" = USED MEASURED DIMENSION (REF)  
 "P" =  $(("M" - .200[5.08]) / 2) \pm .020[.51]$

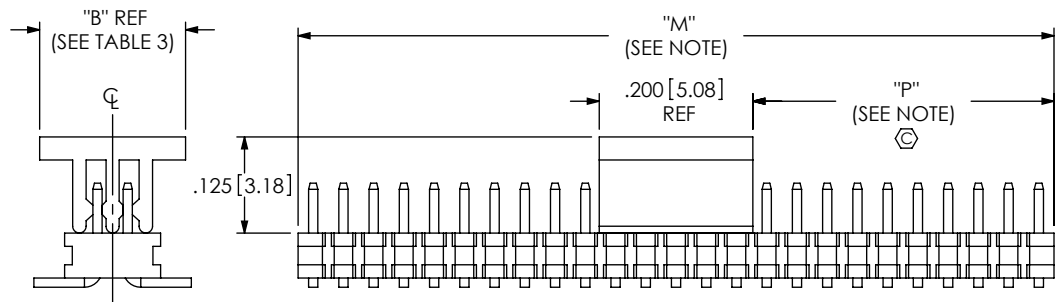

FIG 3  
 -P: PICK & PLACE PAD  
 FTMH-125-03-X-DV-P SHOWN  
 (DIFFERENT AS SHOWN, OTHERWISE SAME AS FIG 1)

TABLE 3	
PAD	"B"
PPP-30	.125[3.18]
PPP-30-NT	.190[4.83]

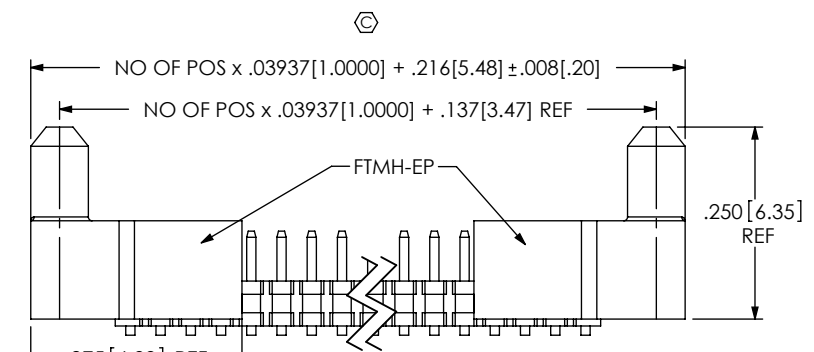

FIG 4  
 -EP: GUIDE POST  
 FTMH-125-03-X-DV-EP SHOWN  
 (DIFFERENT AS SHOWN, OTHERWISE SAME AS FIG 1)

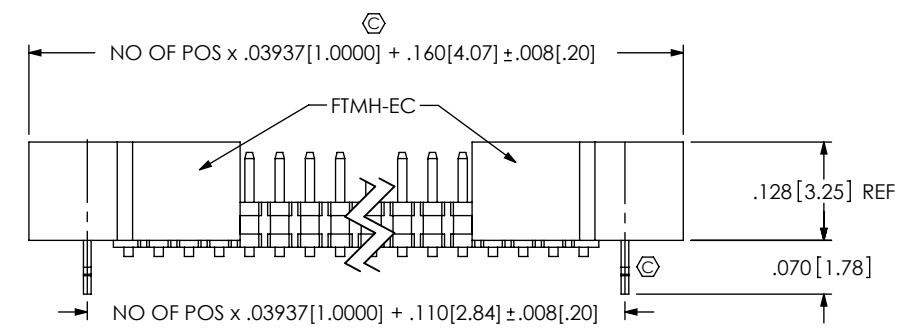
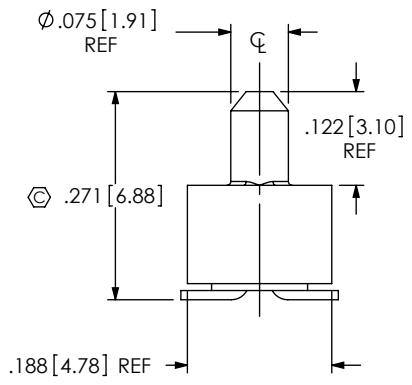
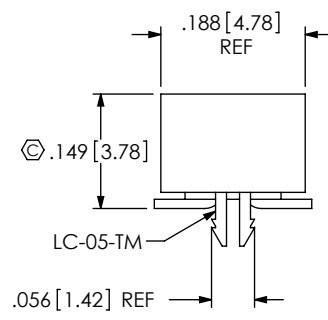

FIG 5  
 -EC: LOCKING CLIP  
 FTMH-125-03-X-DV-EC SHOWN  
 (DIFFERENT AS SHOWN, OTHERWISE SAME AS FIG 1)



PROPRIETARY NOTE  
 THIS DOCUMENT CONTAINS INFORMATION  
 CONFIDENTIAL AND PROPRIETARY TO  
 SAMTEC, INC. AND SHALL NOT BE REPRODUCED  
 OR TRANSFERRED TO OTHER DOCUMENTS OR  
 DISCLOSED TO OTHERS OR USED FOR ANY  
 PURPOSE OTHER THAN THAT WHICH IT WAS  
 OBTAINED WITHOUT THE EXPRESSED WRITTEN  
 CONSENT OF SAMTEC, INC.

DO NOT SCALE DRAWING

SHEET SCALE: 5:1



520 PARK EAST BLVD, NEW ALBANY, IN 47150  
 PHONE: 812-944-6733 FAX: 812-948-5047  
 e-Mail: info@SAMTEC.com code: 55322

DESCRIPTION:  
 1mm x 1mm DOUBLE VERTICAL SMT TERMINAL STRIP

DWG. NO.  
**FTMH-1XX-XX-XX-DV-XX**

BY: PURVIS 04-22-96 SHEET 4 OF 5

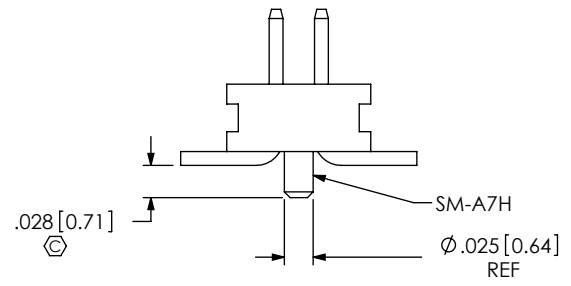
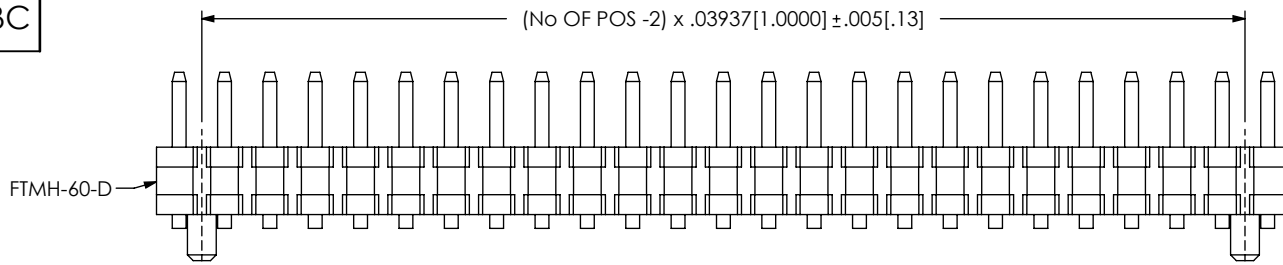

**FIG 6**  
 -A: ALIGNMENT PIN (STAKED)  
 (MIN 7 POSITIONS)  
 FTMH-125-03-X-DV-A SHOWN  
 (DIFFERENT AS SHOWN, OTHERWISE SAME AS FIG 1)

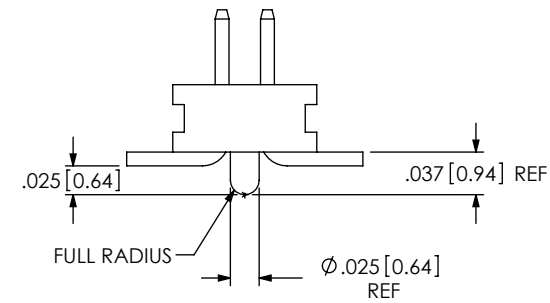
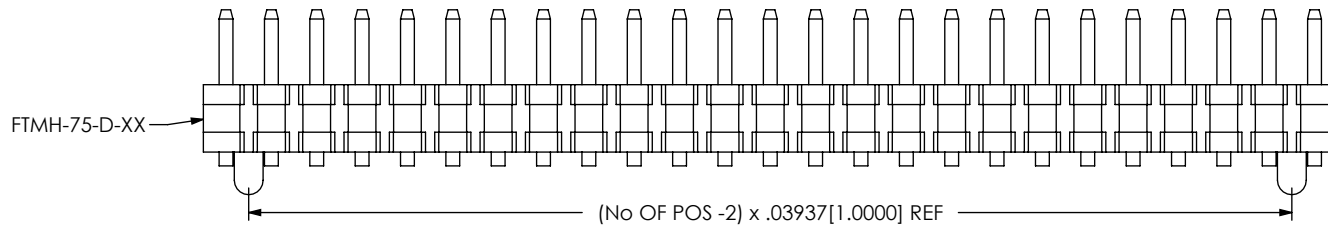

**FIG 7**  
 -A: ALIGNMENT PIN (MOLDED)  
 (MIN 3 POSITIONS)  
 FTMH-125-03-X-DV-A SHOWN  
 (DIFFERENT AS SHOWN, OTHERWISE SAME AS FIG 1)

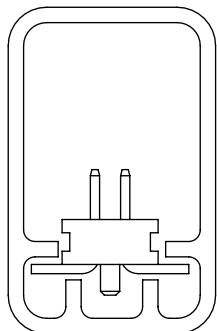

-A OPTION  
 PT-T-24-01-60

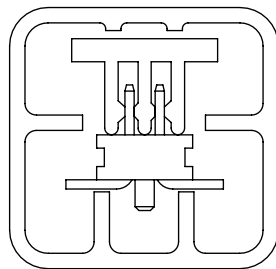

-A-P OPTION  
 PT-T-24-05-63

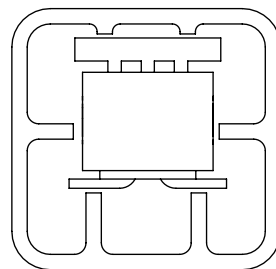

-ES-P OPTION  
 PT-T-24-01-63

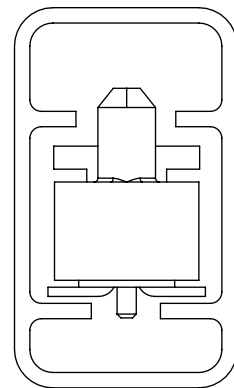

-EP-A-P OPTION  
 PT-T-24-02-15

**PACKAGING VIEWS**

TABLE 2			
(SEE NOTE 5 FOR PACKAGING NOTES)			
LEAD STYLE	OPTION (S)	PACKAGING TUBE	TUBE PLUG
-02, -03	-NONE	PT-1-24-01-60	TP-03 (x 2)
-02, -03	-A	PT-1-24-01-60	TP-03 (x 2)
-02, -03	-P, -A-P	PT-1-24-05-63	TP-24 (x 2)
-02, -03	-ES, -ES-P, -ES-A, EP	PT-1-24-01-63	TP-24 (x 2)
-02, -03	-EC, -EC-P, -EC-A	PT-1-24-01-60	TP-03 (x 2)
-02, -03	-EP-A, -EP-A-P	PT-1-24-02-15	TP-03 (x 2)

**PROPRIETARY NOTE**  
 THIS DOCUMENT CONTAINS INFORMATION CONFIDENTIAL AND PROPRIETARY TO SAMTEC, INC. AND SHALL NOT BE REPRODUCED OR TRANSFERRED TO OTHER DOCUMENTS OR DISCLOSED TO OTHERS OR USED FOR ANY PURPOSE OTHER THAN THAT WHICH IT WAS OBTAINED WITHOUT THE EXPRESSED WRITTEN CONSENT OF SAMTEC, INC.

DO NOT SCALE DRAWING

SHEET SCALE: 5:1



520 PARK EAST BLVD, NEW ALBANY, IN 47150  
 PHONE: 812-944-6733 FAX: 812-948-5047  
 e-Mail: info@SAMTEC.com code: 55322

DESCRIPTION:  
 1mm x 1mm DOUBLE VERTICAL SMT TERMINAL STRIP

DWG. NO.  
**FTMH-1XX-XX-XX-DV-XX**

BY: PURVIS 04-22-96 SHEET 5 OF 5

# Mouser Electronics

Authorized Distributor

Click to View Pricing, Inventory, Delivery & Lifecycle Information:

[Samtec:](#)

[FTMH-130-02-L-DV-ES-A-P](#)