

STRAIGHT JACK CRIMP TYPE

R125.225.901

CABLE .141

Series : SMA

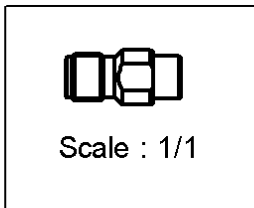
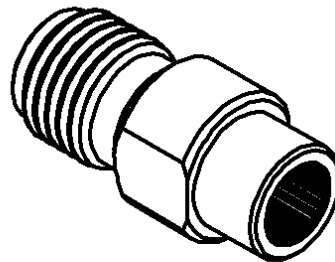
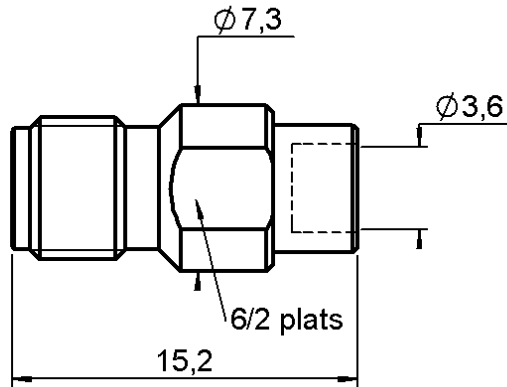

All dimensions are in mm.



COMPONENTS	MATERIALS	PLATINGS (μm)
BODY	STAINLESS STEEL	PASSIVATED .
CENTER CONTACT	BERYLLIUM COPPER	GOLD 1.3 OVER NICKEL 2
OUTER CONTACT	-	-
INSULATOR	PTFE	-
GASKET	-	-
OTHERS PARTS	STAINLESS STEEL	PASSIVATED .
-	-	-
-	-	-

Issue : 0622 C

In the effort to improve our products, we reserve the right to make changes judged to be necessary.



STRAIGHT JACK CRIMP TYPE

R125.225.901

CABLE .141

Series : SMA

PACKAGING

Standard	Unit	Other
100	'W' option	Contact us

SPECIFICATION

CABLE ASSEMBLY

ELECTRICAL CHARACTERISTICS

Stripping	a	b	c	d	e	f
mm	2,16	0,00	0,00	0,00	0,00	0,00

Impedance	50	Ω
Frequency	0-18	GHz
VSWR	1.05 + 0,0100	x F(GHz) Maxi
Insertion loss	0.03	\sqrt{F} (GHz) dB Maxi
RF leakage	- (60)	- F(GHz) dB mini
Voltage rating	500	Veff Maxi
Dielectric withstanding voltage	1000	Veff mini
Insulation resistance	5000	M Ω mini

Assembly instruction :

Recommended cable(s)
RG 402
KS 2

Cable retention

- pull off **270** N mini
- torque **NA** N.cm

MECHANICAL CHARACTERISTICS

TOOLING

Center contact retention		
Axial force – Mating end	27	N mini
Axial force – Opposite end	27	N mini
Torque	2.8	N.cm mini

Part Number	Description	Hexagon
.	.	.
R282.286.000	CRIMPING TOOL	-
R282.703.000	POSITIONER	-
R282.053.000	STRIPPING TOOL	
R282.066.000	POINTER GAUGE	
R282.711.000	GUIDE	

Recommended torque		
Mating	NA	N.cm
Panel nut	NA	N.cm
Clamp nut	NA	N.cm
A/F clamp nut	0,0000	mm

OTHERS CHARACTERISTICS

Mating life	500	Cycles mini
Weight	2,7000	g

ENVIRONMENTAL

Operating temperature	-65/+105	$^{\circ}$ C
Hermetic seal	NA	Atm.cm3/s
Panel leakage	NA	

Issue : 0622 C

In the effort to improve our products, we reserve the right to make changes judged to be necessary.



STRAIGHT JACK CRIMP TYPE

R125.225.901

CABLE .141

Series : SMA

COMPONENTS

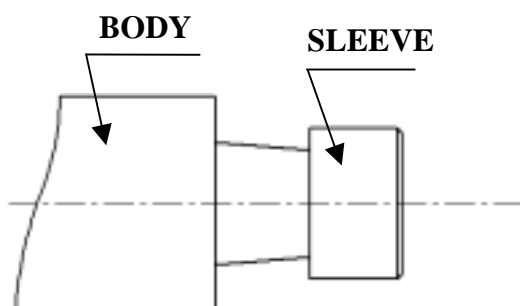

STIPPING DIMENSIONS

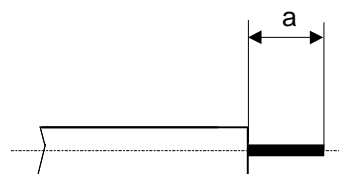

1

- Strip the cable with the cable stripping tool
- Trim the cable inner conductor with the trimmer.

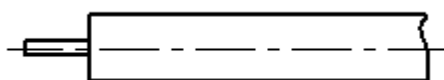

3

- Insert the connector and the cable on the crimping tool with guide and positioner.
- A pneumatic crimping tool exist too that can be used

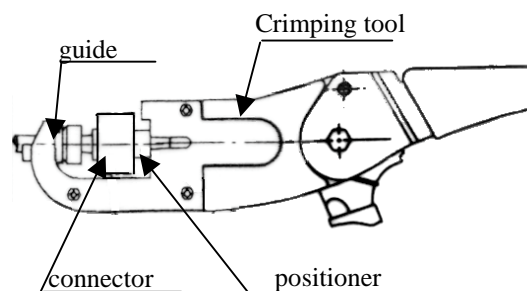

2

- Slide connector onto the cable

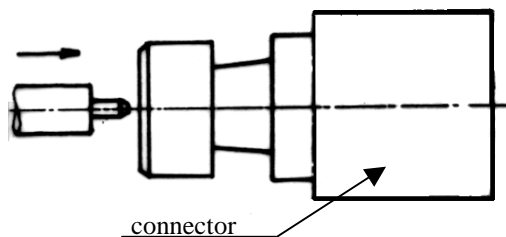

4

- Press the connector on the cable.

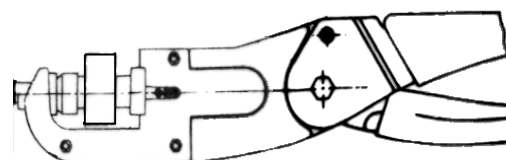

Issue : 0622 C

In the effort to improve our products, we reserve the right to make changes judged to be necessary.



Mouser Electronics

Authorized Distributor

Click to View Pricing, Inventory, Delivery & Lifecycle Information:

Radial:

[R125225901](#)