



## SMA/SMA-COM/BMA

R125/R124/R128

**Contents****BMA**

Introduction .....	7-4
Characteristics .....	7-5
Plugs .....	7-6
Jacks .....	7-7 to 7-8
Receptacles .....	7-8 to 7-11
Panel drilling .....	7-11 to 7-12

**SMA**

Introduction .....	7-13 to 7-14
Interface .....	7-15
Characteristics .....	7-16 to 7-17
Straight plugs .....	7-17 to 7-18
Right angle plugs .....	7-19 to 7-21
Straight jacks .....	7-22
Bulkhead jacks .....	7-23 to 7-25
Receptacles .....	7-26 to 7-30
Receptacles for microstrip .....	7-31 to 7-32
Hermetic receptacles with separate glass bead .....	7-33
Hermetic receptacles with integrated glass bead .....	7-34
Hermetic receptacles without glass bead .....	7-35
Adapters .....	7-35 to 7-36
Accessories .....	7-36
Glass beads .....	7-37
Accessories for hermetic microstrip receptacles .....	7-38
Panel drilling .....	7-38 to 7-40
Tooling for hermetic receptacles .....	7-40
Field replaceable hermetic microstrip receptacle information .....	7-41 to 7-42

**SMA-COM**

Introduction .....	7-43 to 7-44
Interface .....	7-45
Characteristics .....	7-46
Plugs .....	7-47 to 7-48
Jacks .....	7-48 to 7-49
Receptacles and switches .....	7-50 to 7-52
Panel drilling .....	7-52
Assembly instructions .....	7-53 to 7-54

**Introduction**

	<b>BMA</b>
50Ω	DC - 22 GHz

**GENERAL**

- Blind mate connector
- Slide-on coupling
- High frequency
- Float mount design allows large axial and radial misalignment

**APPLICABLE STANDARDS**

- MIL-STD-348 Fig. 321
- CEI 1169-33
- Compatible with OSP series

**APPLICATIONS**

- Airborne and ground radars
- Active electronically scanned array antennas
- Rack and panel telecommunication equipment
- Military microwave modules

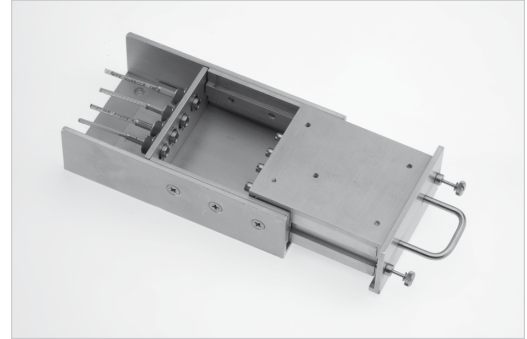

Radiall's BMA series has been designed for applications where reliability, durability and performance at high frequency is essential. BMA is a blind mate connector widely used to interconnect microwave modules with multiple coaxial ports. Float mount connectors are recommended for multiple interconnects. Contact Radiall for mounting tolerances.

**WIDE RANGE**

The BMA product range consists of cable connectors for flexible cables, semi-rigid cables and SHF cables, floating bulkhead or flange mount, PCB receptacles, press mount receptacles, screw-on receptacles, hermetic receptacles, coaxial contacts for rectangular or circular multipin connectors and adapters.

**NEW SPRING FINGERS OUTER CONTACT**

In 2007, a new outer contact was designed and introduced on all BMA female connectors. The new spring fingers outer contact provides improved performance and stability at high frequency up to 22 GHz. Old BMA female part numbers are obsolete and have been replaced with new part numbers which are listed in this catalog.

## Characteristics

Test / Characteristics	Values / Remarks	
<b>ELECTRICAL CHARACTERISTICS</b>		
Impedance	50Ω	
Frequency range	DC - 22 GHz	
V.S.W.R.	.085"/ RG405 semi-rigid cable: 1.05 + 0.01 F (GHz)	
Insertion loss (typ.) dB	0.03 √ F (GHz)	
RF leakage (min.) dB	-90 + F (GHz) for gold and BBR connector body -80 + F (GHz) for passivated connector body	
Insulation resistance	≥ 5000 MΩ	
Contact resistance	Center contact: 5 mΩ max. / Outer contact: 2.5 mΩ max.	
Voltage in V. RMS • At sea level • At 70000 ft	Dielectric withstanding voltage ≥ 1000 V. 200 V.	Working voltage ≤ 335 V. 85 V.

**MECHANICAL CHARACTERISTICS**

Durability	>1000 cycles	
Force to engage	13.6 N (3 lbf) max.	
Force to disengage	0.56 N (0.13 lbf) min.	
Cable retention force	.085"/ RG405 cable	.141"/ RG402 cable
	> 136 N (30 lbf)	> 272 N (61 lbf)
Center contact retention force	27 N (6 lbf) min.	
Misalignment • Radial misalignment • Axial misalignment	Fixed mount ± 0.1mm (.004 in) 0.38mm (.015 in) max.	Float mount ± 0.51mm (.020 in) 1.52mm (.060 in) min.

**ENVIRONMENTAL CHARACTERISTICS**

Temperature range • Standard models • Semi-rigid cables	-65°C / + 165°C -65°C / +105°C
Thermal cycling	MIL-STD-202, Method 107, Condition B, -65°C / +125°C
Vibration	MIL-STD-202, Method 204, Condition D, 20 g
Shock	MIL-STD-202, Method 213, Condition A, 50 g
Bumps	CECC 22000, Paragraph 4.6.2, 4000 bumps per axis
Moisture resistance	MIL-STD-202, Method 106
Corrosion	MIL-STD-202, Method 101, Condition A, 96H
Degree of protection	IP54 (male connector with O-ring)

**MATERIALS AND PLATING**

	Material	Plating
Body/Nut	Stainless steel (standard BMA) Brass (commercial BMA)	Gold or Passivated BBR
Center contacts	Brass (male) Beryllium copper (female)	Gold over Nickel or NPGR
Outer contact	Beryllium copper	NPGR
Gaskets	Silicon rubber	-
Insulators	PTFE	-

Plugs and Contacts

**STRAIGHT PLUGS, SOLDER TYPE FOR SEMI-RIGID CABLES**

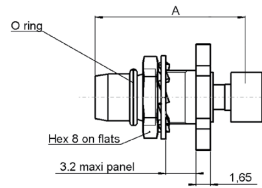

Fig. 1

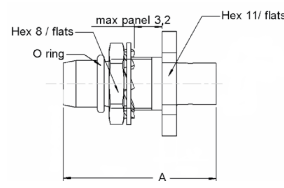

Fig. 2

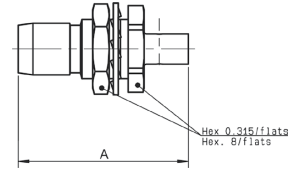

Fig. 3

Cable group	Cable group dia.	Part number	Fig.	Dimension A (mm)	Panel drilling	Body	Finish	Captive center contact	Note
RG405	.085"	R128 052 901	1	17	P01	Stainless steel	Passivated	Yes (epoxy)	Crimp type, easy installation
		R128 052 000	2				Gold		-
		R128 052 827	3				Brass	BBR	Yes (4 indents)
RG402	.141"	R128 055 000	2	17.6	P01	Stainless steel	Gold	Yes (epoxy)	-
		R128 055 827	3				Brass	BBR	Yes (4 indents)

**STRAIGHT BULKHEAD PLUGS CRIMP TYPE FOR FLEXIBLE CABLE**

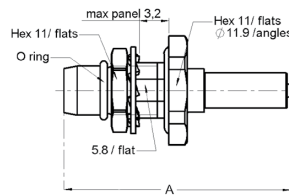

Fig. 1

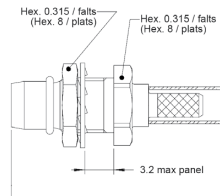

Fig. 2

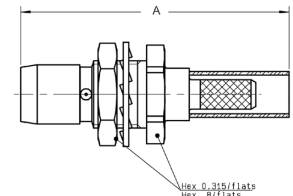

Fig. 3

Cable group	Cable group dia.	Part number	Fig.	Dimension A (mm)	Panel drilling	Body & finish	Captive center contact	Note
RG174 / RG316	2.6/50/S	R128 081 001	1	24.6	P02	Stainless steel passivated	Yes (barb)	Waterproof
		R128 083 001	2				Yes (epoxy)	-
		R128 083 827	3				Brass BBR	Yes (4 indents)
RD316	2.6/50/D	R128 084 827						
RG142 / RG223 / RG400	5/50D	R128 088 827		24.2	P01	Brass BBR	Yes (4 indents)	No O-ring

**STRAIGHT CONTACTS SIZE 8 FOR MIL-STD-38999 CONNECTORS SOLDER TYPE**

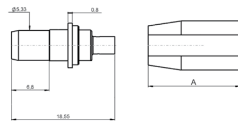

Fig. 1

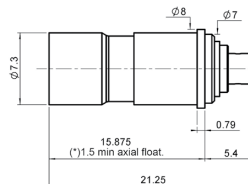

Fig. 2

Cable group	Cable group dia.	Part number	Body & finish	Fig.	Captive center contact	Gender
RG405	.085"	R128 053 000	Stainless steel gold plated	1	Yes (epoxy)	Pin
		R128 294 710		2		Socket
RG402	.141"	R128 056 000		1		Pin
		R128 296 710		2		Socket

Jacks

STRAIGHT FLOATING JACKS SOLDER TYPE FOR SEMI-RIGID CABLE

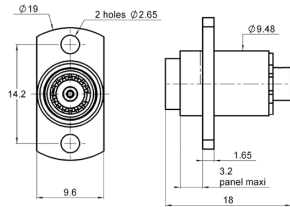
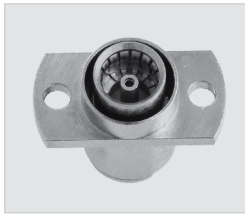

Fig. 1

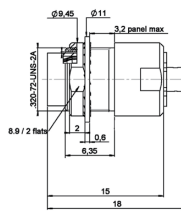

Fig. 2

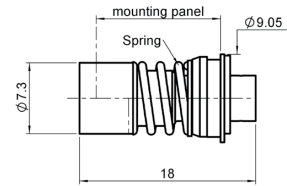

Fig. 3

Cable group	Cable group dia.	Part number	Fig.	Panel drilling	Body & finish	Captive center contact	Panel mount
RG405	.085"	R128 292 700	1	P03	Stainless steel gold plated	Yes (epoxy)	2-hole flange
		R128 292 727					
		R128 293 702	2	P18	Brass BBR	Yes (4 indents)	Bulkhead
RG402	.141"	R128 294 700	3	P04	Stainless steel gold plated	Yes (epoxy)	Snap-in
		R128 296 700					
		R128 295 700	1	P03	Brass BBR	Yes (4 indents)	2-hole flange
		R128 295 727					

STRAIGHT FLOATING JACKS CRIMP TYPE FOR FLEXIBLE CABLE

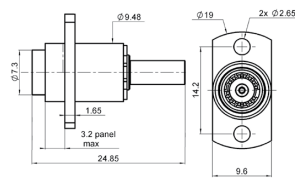

Fig. 1

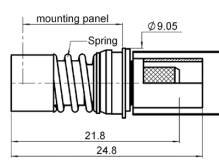

Fig. 2

Cable group	Cable group dia.	Part number	Fig.	Panel drilling	Body & finish	Captive center contact	Panel mount
RG174 / RG316	2.6/50S	R128 263 707	1	P03	Brass BBR	Yes (4 indents)	2-hole flange
RD316	2.6/50D	R128 264 707					
RG142 / RG223 / RG400	5/50/D	R128 268 717					
RG174 / RG316	2.6/50/S	R128 263 711					
RG142 / RG223 / RG400	5/50/D	R128 268 701	2	P04	Stainless steel passivated	Yes (epoxy)	Snap-in
RG174 / RG316	2.6/50/S	R128 233 701					
RG142 / RG223 / RG400	5/50/D	R128 238 701					

## Jacks and Receptacles

### RIGHT ANGLE FLOATING JACKS FOR SEMI-RIGID AND FLEXIBLE CABLE

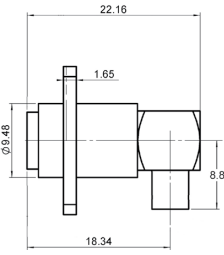

Fig. 1

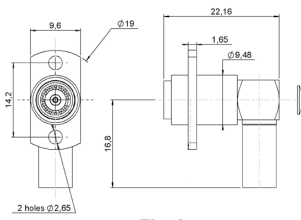

Fig. 2

Cable group	Cable group dia.	Part number	Fig.	Panel drilling	Body & finish	Captive center contact	Note
RG402	.141"	R128 359 707	1	P03	Brass BBR	Yes (4 indents)	Solder type
RG405	.085"	R128 360 701			Stainless steel passivated	Yes (epoxy)	
		R128 360 717			Brass BBR	Yes (4 indents)	
RG142 / RG223 / RG400	5/50/D	R128 368 707	2			Yes (4 indents)	Crimp type

### STRAIGHT SMT MALE RECEPTACLES

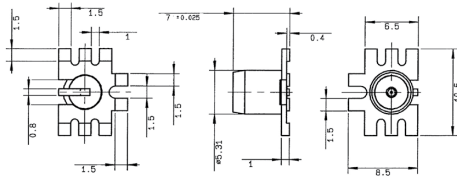

Fig. 1

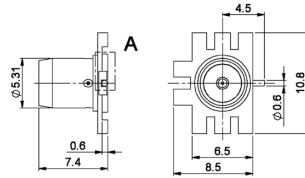

Fig. 2

Part number	Fig.	Body & finish	Captive center contact	Note
R128 424 848	1	Brass, tin plated	Yes (4 indents)	-
R128 424 860	2	Brass NPGR		Tape & Reel 250pcs

### PCB MALE RECEPTACLES

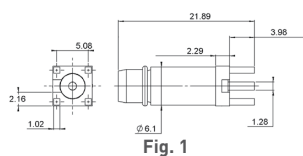

Fig. 1

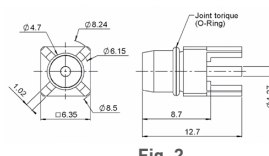

Fig. 2

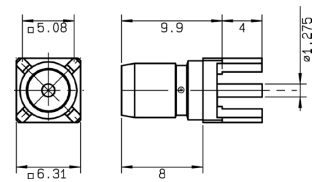

Fig. 3

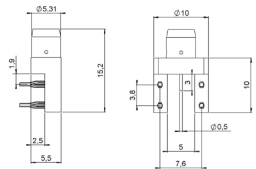

Fig. 4

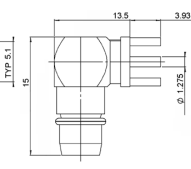

Fig. 5

Part number	Fig.	Panel drilling	Body & finish	Captive center contact	Note
R128 425 110	1	P09	Stainless steel gold plated	Yes (barb)	-
R128 425 300	2			Yes (epoxy)	-
R128 425 820	3	P07	Brass gold plated	Yes (4 indents)	No O-ring
R128 405 161	4	-			Press-fit edge-card type
R128 665 820	5	P07			No O-ring
R128 665 100		P09	Stainless steel gold plated	Yes	-

Receptacles

PCB FEMALE RECEPTACLES

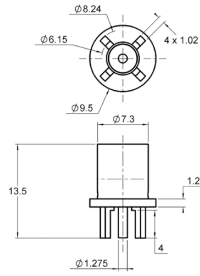

Fig. 1

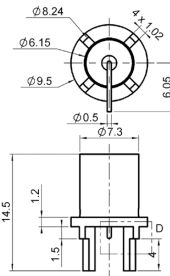

Fig. 2

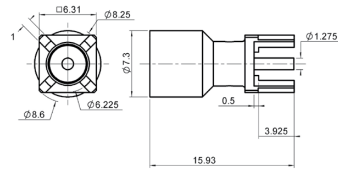

Fig. 3

Part number	Fig.	Panel drilling	Body & finish	Captive center contact
R128 426 700	3	P09	Brass gold plated	Yes (4 indents)
R128 426 710	1	P10	Stainless steel gold plated	Yes (epoxy)
R128 427 700	2	P11		

NARROW AND SQUARE FLANGE EXTENDED DIELECTRIC MALE RECEPTACLES

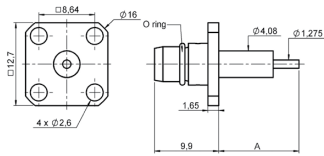

Fig. 1

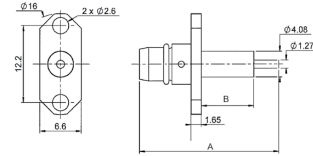

Fig. 2

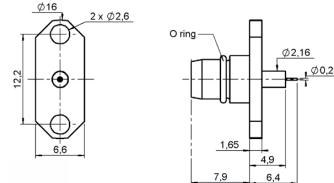

Fig. 3

Part number	Fig.	Dimension		Panel drilling	Body & finish	Captive center contact	Panel mount	Note
		A (mm)	B (mm)					
R128 444 201	1	12.4	8.4	P06	Stainless steel passivated	Yes (epoxy)	4 hole flange	-
R128 444 307		10.7	5.6		Brass BBR	Yes (4 indents)		No O-ring
R128 474 201	2	22.3	8.4	P05	Stainless steel passivated	Yes (epoxy)	2 hole flange	-
R128 474 211		17.4	5		Brass BBR	Yes (4 indents)		
R128 474 847		16.4						
R128 474 857		22.3	8.4					
R128 484 001	3	-	-	P13	Stainless steel passivated	Yes (epoxy)		

NARROW AND SQUARE FLANGE EXTENDED DIELECTRIC FEMALE RECEPTACLES

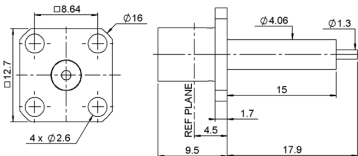

Fig. 1

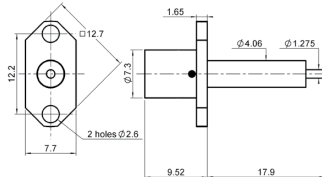

Fig. 2

Part number	Fig.	Panel drilling	Body & finish	Captive center contact	Note
R128 414 701	1	P06	Stainless steel passivated	Yes (epoxy)	Square flange
R128 464 701	2	P12			2 hole flange



Receptacles

**SPECIAL FLANGE MALE RECEPTACLE**

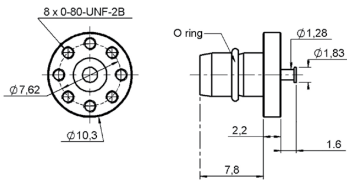

Part number	Panel drilling	Body & finish	Captive center contact	Note
R128 545 011	P16	Stainless steel passivated	No	Turret contact type

**NARROW FLANGE REPLACEABLE MALE RECEPTACLES**

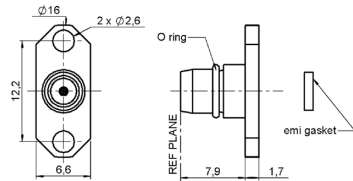

Part number	Panel drilling	Body & finish	Captive center contact	Accept pin diameter	Note
R128 490 021	P13	Stainless steel passivated	Yes (epoxy)	0.93 mm	No EMI gasket
R128 481 001				0.3 mm	EMI gasket
R128 481 011				0.5 mm	

**SCREW-ON AND PRESS-FIT MALE RECEPTACLES**

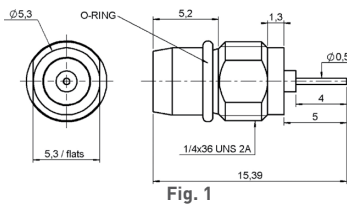

Fig. 1

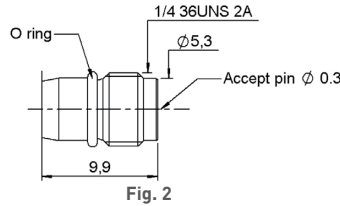

Fig. 2

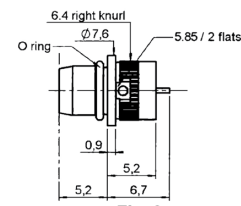

Fig. 3

Part number	Fig.	Panel drilling	Body & finish	Captive center contact	Panel mount	Note
R128 555 101	1	P14	Stainless steel passivated	Yes (epoxy)	Screw-on	Cylindrical
R128 556 001	2	P15				Socket
R128 595 001	3	P08			Press-fit	Cylindrical

**SCREW-ON HERMETIC RECEPTACLES WITH EMI GASKET (with integrated glass bead)**

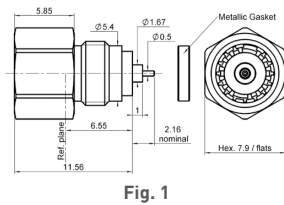

Fig. 1

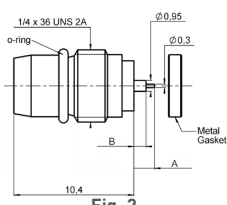

Fig. 2

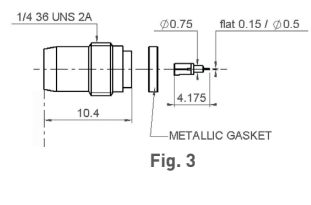
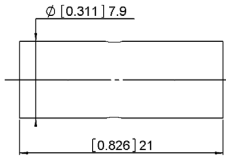

Fig. 3

Part number	Fig.	Dimension		Body & finish	Captive center contact	Note
		A (mm)	B (mm)			
R128 609 701	1	-	-	Stainless steel passivated	Yes	Female
R128 639 000	2	1.8	1			Stainless steel gold plated
R128 639 001		3				
R128 639 020		1.8	1.05			
R128 639 100		3	-	-	Stainless steel passivated	Male, with auxiliary contact, no O-ring

Receptacles

FEMALE-FEMALE STRAIGHT ADAPTER



Part number	Body & finish	Captive center contact
R128 705 711	Stainless steel passivated	Yes (epoxy)

Panel Drilling

P01

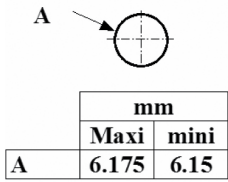

P02

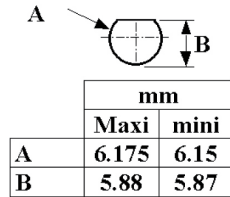

P03

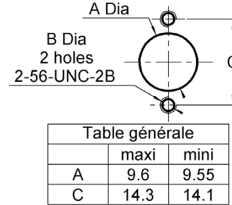

P04

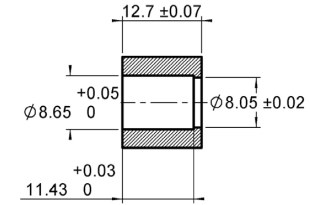

P05

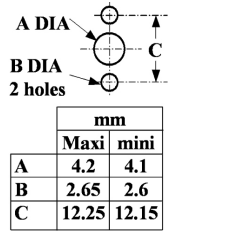

P06

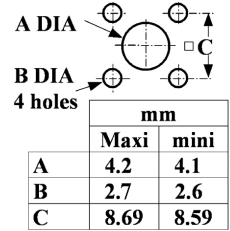

P07

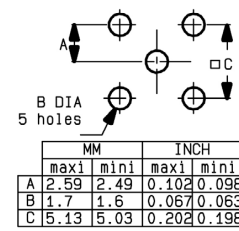

P08

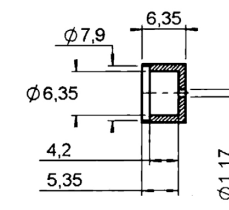

P09

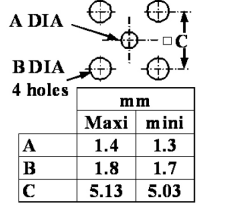

P10

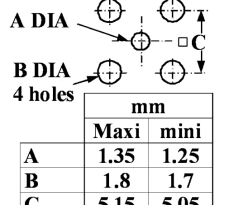

P011

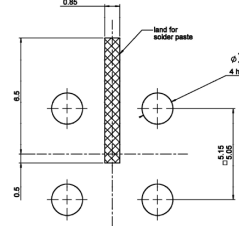

P12

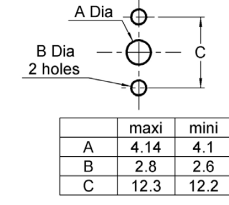

P13

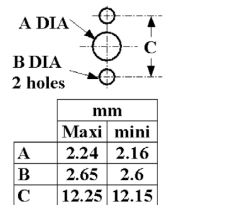

P14

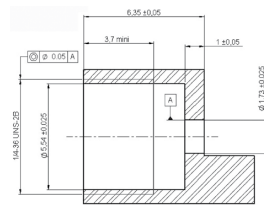

P15

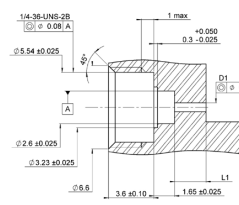

P16

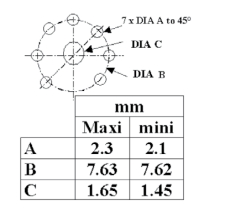

Panel Drilling

HERMETIC GLASS BEAD RECEPTACLES

P17

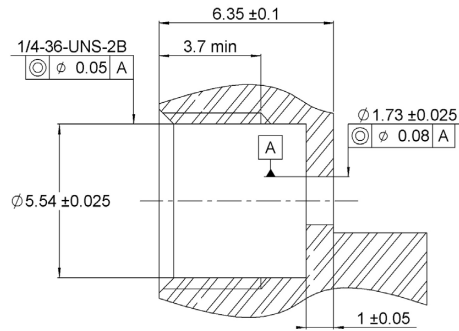

INSTALLATION TOOLS FOR HERMETIC RECEPTACLES

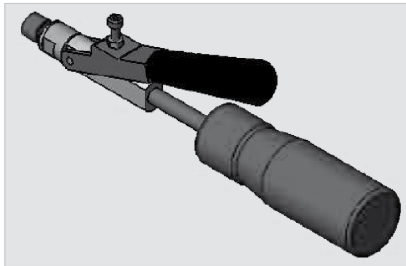

Part number	Body & finish	Captive center contact
R282 340 000	280 N.cm	Tool for male receptacles R128 639 xxx

## Introduction

Radiall stainless steel SMA connectors have been designed for applications where reliability, durability, robustness and high frequency are critical.

### • WIDE RANGE

The stainless steel SMA range offers cable connectors for both flexible or semi-rigid cables, panel and PCB mount receptacles, press mount, microstrip, universal, through hole pins and end launch connectors. In series adapters and between series adapters including PUSH-ON interface are also available.

All Radiall stainless steel SMA connectors can be mated with Radiall commercial (brass) SMA connectors.

### • CONVENIENT 3-PIECE DESIGN ON MOST CONNECTORS FOR FLEXIBLE CABLES

- For straight models: single piece body + center contact + outer ferrule
- For right angle models: single piece body + cap + outer ferrule

### • FAST AND RELIABLE CABLE ATTACHMENT

The cable connectors can be either fully crimped or soldered/crimped, offering full flexibility for high volume production with standard manual or pneumatic tooling: fast and reliable.

- The center contact can be either crimped or soldered
- The outer contact is attached to the cable by crimping a ferrule

### • SIMPLE SNAP-IN CENTER CONTACT CAPTIVATION (FOR FULL CRIMP MODELS)

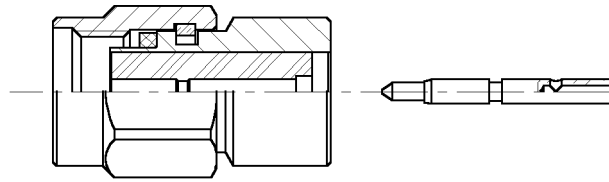

The relative position of the center contact into the interface is mechanically guaranteed by the snapping of the insulator inner shoulder into the groove of the center contact.

This design facilitates the captivation operation in contrast of other designs, requiring 2 insulators to provide contact retention.

### • EXTENDED FREQUENCY SMA DC-27 GHz

Radiall offers an extended frequency SMA range allowing coaxial system operation up to 27 GHz. This series mates with the standard SMA series and maintains the same mechanical characteristics (part numbers ending with 700, 701 or 702).

### • SOLDERLESS ATTACHMENT TO SEMI-RIGID CABLE

Radiall's SMA crimp connector series offers an exciting alternative for assembling SMA connectors to semi-rigid cable. The main advantages of these connectors are: time savings, repeatability and performance.



## Introduction

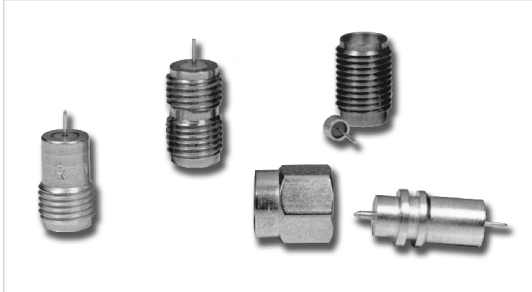

- **SMA HERMETIC**

Hermetic connectors are required to maintain a pressurized or vacuum environment inside a micro-electronic package. Radiall offers 3 types of hermetic connectors:

1. **Field replaceable hermetic receptacles with separate glass bead**

(leakage rate below  $10^{-8}$  atm.cm<sup>3</sup>/sec)

The hermeticity level is guaranteed by the glass bead soldered into the package. A large selection of glass beads is available from dia 0.3 to 0.5 mm. They are usually ordered separately from the receptacle. The receptacle can be removed (field replaceable) from the package for maintenance without any risk of leakage. The field replaceable receptacle is recommended when a high number of matings is required.

2. **Hermetic receptacles with integrated glass bead**

(leakage rate below  $10^{-8}$  atm.cm<sup>3</sup>/sec)

The glass bead is already in place inside the receptacle, hermeticity is guaranteed by a solder joint between the receptacle and the package or with a metallic compression gasket. Screw-on receptacle with metallic compression gasket offers superior climatic resistance: -65°C +200°C.

3. **Hermetic receptacles without glass bead**

(leakage rate below  $10^{-6}$  atm/cm<sup>3</sup>/sec)

A good hermeticity level is obtained with a metallic gasket at a cost advantage compared to glass beads.



50Ω

DC - 18 GHz  
DC - 27 GHz**GENERAL**

- Sub-miniature coaxial connectors
- Screw-on coupling
- High RF performance
- 2 plating options:
  - passivated stainless steel
  - gold plated
- Wide hermetically sealed range
- Space qualified range of products
- SMA extended frequency 27 GHz

**APPLICABLE STANDARDS**

- MIL-C-39012
- EC 169-1
- CECC 22110
- CECC 22111 - 801 to 808
- BS 9210 N006

**SPACE QUALIFIED/APPROVALS**

(For space range)

- SCC 3402 (ESA)
- CNES

**APPLICATIONS**

- Civil & Military Telecommunications
- Civil & Military Aeronautics
- Military equipment
- Space
- Measurement systems

**PLUG**

**JACK**

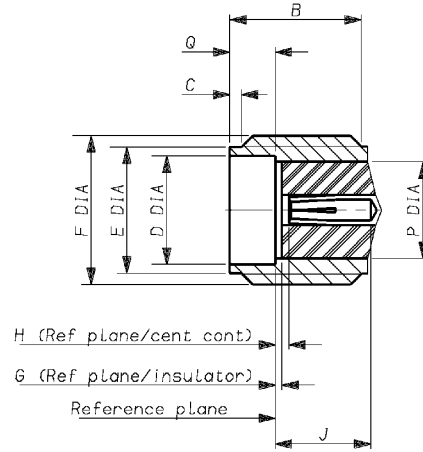
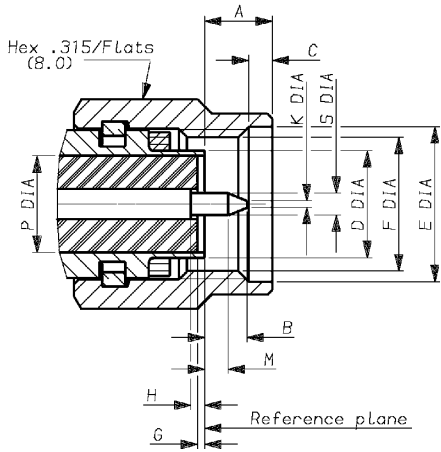

Letter	mm		inch	
	min.	max.	min.	max.
A	-	3.43	-	.135
B	-	2.54	-	.100
C	0.38	1.14	.015	.045
D DIA	-	4.59	-	-
E	6.35	-	.250	-
F DIA	1/4 36 UNS 2B			
G*	0.0	-0.20	0.0	-.008
H*	0.0	-0.25	0.0	-.010
J	-	-	-	-
K DIA	-	0.38	-	.015
M	1.27	-	.050	-
P DIA	4.10 nom.		.161 nom.	
Q DIA	-	-	-	-
S DIA	0.90	0.94	.035	.037

Letter	mm		inch	
	min.	max.	min.	max.
A	-	-	-	-
B	4.31	-	.170	-
C	0.38	1.14	.015	.045
D DIA	4.596	-	.181	-
E DIA	5.28	5.49	.208	.216
F DIA	1/4 36 UNS 2A			
G*	0.0	-0.20	0.0	-.008
H*	0.0	-0.25	0.0	-.010
J	2.92	-	.115	-
K	-	-	-	-
M	-	-	-	-
P DIA	4.10 nom.		.161 nom.	
Q	1.88	1.98	.074	.078
S DIA	-	-	-	-

**NOTE:**  
Means behind ref plane

## Characteristics

Test / Characteristics	Values / Remarks
------------------------	------------------

## ELECTRICAL CHARACTERISTICS

Impedance		50Ω						
Frequency range		DC - 18 GHz					Extended	
V.S.W.R. (typ.) • Straight connector  • Right angle connector	Frequency	1 GHz	2.4 GHz	6 GHz	12.4 GHz	18 GHz	27 GHz	
	.085"	1.01	1.01	1.04	1.06	1.06	1.12	
	.141"	1.01	1.01	1.01	1.03	1.05	1.10	
	2.6/50S	1.05	1.07	1.12	1.15	-	-	
	5/50S	1.04	1.05	1.10	1.12	-	-	
	.085"	1.01	1.02	1.06	1.14	-	-	
	.141"	1.01	1.02	1.08	1.10	-	-	
	2.6/50S	1.06	1.15	1.18	1.24	-	-	
	5/50S	1.06	1.15	1.15	1.25	-	-	
	Insertion loss (typ.) dB • Straight connector  • Right angle connector	.085"	0.03	0.03	0.05	0.08	0.10	0.15
		.141"	0.02	0.02	0.02	0.02	0.02	0.10
		2.6/50S	0.06√F (F in GHz) max					
5/50S		0.06√F (F in GHz) max						
.085"		0.04	0.04	0.04	0.08	-	-	
.141"		0.04	0.05	0.06	0.09	-	-	
RF leakage (dB max) • Connectors for semi-rigid cables solder attachment • Connectors for flexible cables crimp attachment • Receptacles	- 90 + F (GHz)							
	-							
	- 60 + F (GHz)							
	- 100 + F (GHz)							
Insulation resistance		5 000 MΩ min						
Contact resistance • Outer conductor • Inner conductor		After tests 4 mΩ 3 mΩ			Initial 3 mΩ 2 mΩ			
Working voltage in VRMS • Sea level • 70 000 ft (21000 m)	.085", RG 405, KS 1	.141", RG 402, KS 2	RG 174, 188, 316, KX 3, KX 22		RG 55, 142, 223, KX 23			
	350	500	250		335			
	85	125	65		85			
Dielectric withstanding voltage in VRMS		1000	1500	750		1000		
RF testing voltage at in VRMS		670	1000	500		670		

## MECHANICAL CHARACTERISTICS

Durability		500 matings			
Force to engage and disengage		23 Ncm - (2 inch pounds)			
Recommended coupling nut torque		80 to 115 Ncm - (7 to 10 inch pounds)			
Coupling nut retention force		270 N - (60 Lbs)			
Cable retention force	.085", RG 405, KS 1	.141", RG 402, KS 2	RG 174, 188, 316, KX 3, KX 22		RG 55, 142, 223, KX 23
	135 N (30 Lbs)	270 N (60 Lbs)	110 N (25 Lbs)		180 N (40 Lbs)
Center contact retention force • Axial • Torque		27 N 2.8 N			

Characteristics

Test / Characteristics	Values / Remarks
<b>ENVIRONMENTAL CHARACTERISTICS</b>	
Temperature range • Standard models • Semi-rigid cables • R125 753 000	-65°C / + 165°C -65°C / +105°C -40°C / +100°C
Thermal shock	MIL STD 202, method 107, condition B
High temperature test	MIL STD 202, method 108
Corrosion (salt spray)	MIL STD 202, method 101, condition B
Vibration	MIL STD 202, method 204, condition D, 20g
Shock	MIL STD 202, method 213
Moisture resistance	MIL STD 202, method 106
Hermetic test	Down to 10 <sup>-6</sup> mmHg (Torr) leakage rate < 10 <sup>-6</sup> atm/cm <sup>3</sup> /sec
Barometric pressure	MIL STD 202, method 105, condition C

MATERIALS AND PLATING

	Material	Plating
Body/nut	Stainless steel	Passivated or gold plated (bodies)
Center contacts	Beryllium copper (female) Brass (male)	Gold plated
Gaskets	Silicone rubber	-
Insulators	PTFE	-

Standard packaging: 100 pieces

All dimensions are given in mm.

Straight Plugs

STRAIGHT PLUGS FOR FLEXIBLE CABLES

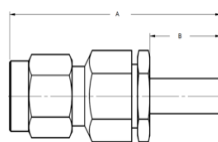
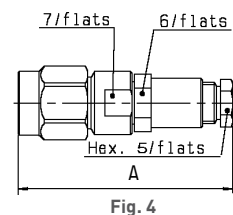
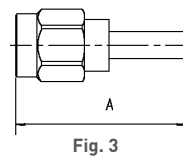
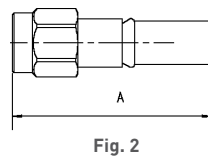
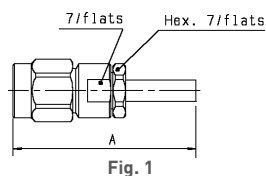

Cable group	Cable group dia.	Part number (Gold)	Part number (Passivated)	Fig.	Dimensions A (mm)	Captive center contact	Assembly type	Note
RG178 / RG196	2/50/S	R125 069 000	-	1	26	Yes	Crimp	-
Special	2.2/50/D	-	R125 002 200	4	25	Yes	Clamp	-
RG174 / RG316	2.6/50/S	R125 071 120	-	3	24.3	Yes	Crimp	Single piece body
		R125 072 000	R125 072 001	2	21.1	No		Single piece body heatshrink sleeve
		R125 073 000	R125 073 001	1	26	Yes	-	
		R125 091 000	R125 091 001	4	2	Yes	Clamp	-
RD316	2.6/50/D	R125 072 080	-	2	20.1	No	Crimp	Single piece body heatshrink sleeve
		R125 072 220	-	3	23.4	Yes		Single piece body
RG58 / RG141	5/50/S	R125 075 000	-	3	24.9	No	Crimp	Single piece body heatshrink sleeve
		R125 077 000	-	1	28	Yes		
RG142 / RG223 / RG400	5/50/D	R125 076 000	R125 076 001	3	25	No		
		R125 078 000	R125 078 001	1	28	Yes		



Straight Plugs

STRAIGHT PLUGS FOR FLEXIBLE CABLES (CONT'D)

Cable group	Cable group dia.	Part number (Gold)	Part number (Passivated)	Fig.	Dimensions A (mm)	Dimensions B (mm)	Captive center contact	Assembly type	Note
RG178 / RG196	2/50/S	9001-1023-002	9001-9023-002	3	20.3	-	No	Crimp	For passivated version, coupling nut only is passivated
		9001-1033-002	9001-9033-002					Solder	
		9001-1553-002	9201-9553-002	5	19.5	0	Yes	Clamp	
		9001-1573-002	9201-9573-002		29.5	9.5		-	
RD178	2/50/D	9001-1023-005	9001-9023-005	3	20.3	-	No	-	
		9001-1033-005	9001-9033-005					Solder	
		9001-1553-005	9001-9553-005	5	19.5	0	Yes	Clamp	
		9001-1573-005	9001-9573-005		29.5	9.5		Crimp	
RG174/RG316	2.6/50/S	9001-1023-003	9001-9023-003	3	20.3	-	No	-	
		9001-1033-003	9001-9033-003					Solder	
		9001-1553-003	9001-9553-003	5	19.5	0	Yes	Clamp	
		9001-1573-003	9001-9573-003		29.5	9.5		-	
RD316	2.6/50/D	9001-1023-019	9001-9023-019	3	20.3	-	No	-	
		9001-1033-019	9001-9033-019					Solder	
		9001-1553-019	9001-9553-019	5	19.5	0	Yes	Clamp	
		9001-1573-019	9001-9573-019		29.5	9.5		Crimp	
RG58/RG141	5/50/S	9001-1023-006	9001-9023-006	3	20.3	-	No	-	
		9001-1033-006	9001-9033-006					Solder	
		9001-1553-006	9001-9553-006	5	19.5	0	Yes	Clamp	
		9001-1573-006	9001-9573-006		29.5	9.5		Crimp	
RG142/RG223/RG400	5/50/D	9001-1023-001	9001-9023-001	3	20.3	-	No	-	
		9001-1033-001	9001-9033-001					Solder	
		9001-1553-001	9001-9553-001	5	19.5	0	Yes	Clamp	
		9001-1573-001	9001-9573-001		29.5	9.5		Crimp	

STRAIGHT PLUGS SOLDER TYPE FOR SEMI-RIGID CABLES

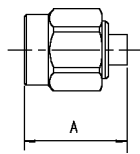
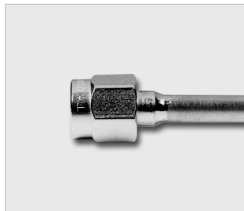

Fig. 1

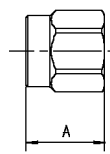

Fig. 2

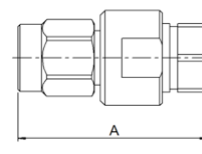

Fig. 3

Cable group	Cable group dia.	Part number (Gold)	Part number (Gold/Passivated coupling nut)	Part number (Nickel)	Fig.	Dimensions A (mm)	Captive center contact	Note
RG405	.085"	R125 052 000	R125 052 002	-	1	11.1	No	Single piece body
		R125 052 170	-	-				Loose parts
		R125 052 500	-	-				Retractable coupling nut / Single piece body
		-	R125 052 702	-				DC-27 GHz Single piece body
RG402	.141"	R125 054 000	R125 054 002	-	2	8.5	N/A	Without center contact
		R125 054 500	-	-		7.5	N/A	Without center contact / Retractable coupling nut
		R125 055 000	R125 055 002	-	1	11.2	no	Single piece body
		R125 055 500	-	-				Retractable coupling nut / Single piece body
		-	R125 055 702	-				DC-27 GHz without center contact
-	R125 057 002	-	N/A	Without center contact				
RG401	.250"	R125 051 000	-	-	3	21.1	No	Two pieces body

## Straight Plugs

## STRAIGHT PLUGS SOLDER TYPE FOR SEMI-RIGID CABLES (CONT'D)

Cable group	Cable group dia.	Part number (Gold)	Part number (Gold/Passivated coupling nut)	Part number (Nickel)	Fig.	Dimensions A (mm)	Captive center contact	Note
RG405	.085"	9501-1593-010	9501-9593-010	-	3	19.5	Yes	Solder-Clamp
		9401-1083-010	-	9401-7083-010	1	11.2	No	Solder type
		9401-1083-210	-	9401-7083-210		8.4		
		9401-1583-010	-	9401-7583-010		11.2	Yes / For one-step cable assembly	
RG402	.141"	9501-1593-009	9501-9593-009	-	3	19.5	Yes	Solder-Clamp
		9401-1083-109	-	9401-7083-109	1	11.2	No	Solder type
		9401-1583-109	-	9401-7583-109			Yes / For one-step cable assembly	
		9301-1063-009	-	9301-7063-009		8.4	N/A	Without center contact

## STRAIGHT PLUGS CRIMP TYPE FOR SEMI-RIGID CABLES

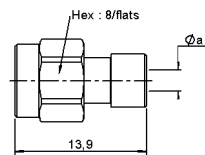

Fig. 1

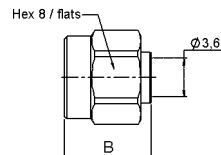

Fig. 2

Cable group	Cable group dia.	Part number (gold/passivated coupling nut)	Fig.	Dimensions A (mm)		Captive center contact	Note
				$\varnothing a$	B		
RG405	.085"	R125 052 901	1	2.2	-	Yes	-
RG402	.141"	R125 053 901	2	-	8.25	N/A	Retractable coupling nut
		R125 054 901	2	-	9.7	N/A	Without center contact
		R125 055 901	1	3.64	-	Yes	-

Right Angle Plugs

RIGHT ANGLE PLUGS FOR FLEXIBLE CABLES

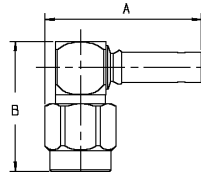

Fig. 1

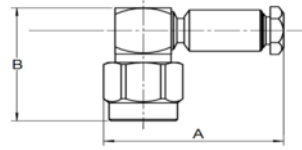

Fig. 2

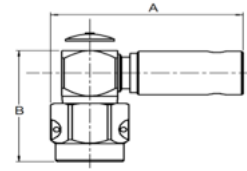

Fig. 3

Cable group	Cable group dia.	Part number (Gold)	Part number (Passivated)	Fig.	Dimensions (mm)		Captive center contact	Assembly type	Note
					A	B			
RG178 / RG196	2/50/S	R125 170 402	-	1	19.6	16.85		Crimp	Incl. heatshrink tube
Special	2.2/50/D	-	R125 163 200	2	20.2			Clamp	-
RG174 / RG316	2.6/50/S	R125 172 000	R125 172 001	1	19.6	16.4	Crimp	Incl. heatshrink tube	
RD316	2.6/50/D	R125 174 000	-	1	18.6				
RG58 / RG141	5/50/S	R125 175 000	R125 175 001	2					
		R125 176 000	R125 176 001	2					
RG142 / RG223 / RG400	5/50/D	R125 176 505	-	3	21.8			Lock wire hole nut Incl. heatshrink tube	
RG178 / RG196	2/50/S	9043-1523-002	9043-9523-002	1	19.3	17	Yes	Crimp	-
		9243-1553-002	9243-9553-002	2	18.8			Clamp	-
		9043-1533-002	-	1	19.3			Solder	-
RD178	2/50/D	9043-1523-005	9043-9523-005	1	19.3			Crimp	-
		9243-1553-005	9243-9553-005	2	18.8			Clamp	-
		9043-1533-005	-	1	19.3			Solder	-
RG174 / RG316	2.6/50/S	90431523-003	9043-9523-003	1	19.3			Crimp	-
		9243-1553-003	9243-9553-003	2	18.8			Clamp	-
		9043-1533-003	-	1	19.3			Solder	-
RD316	2.6/50/D	9043-1523-019	9043-9523-019	1	19.3			Crimp	-
		9243-1553-019	9243-9553-019	2	18.8			Clamp	-
		9043-1533-019	-	1	19.3			Solder	-
RG58 / RG141	5/50/S	9043-1523-006	9043-9523-006	1	19.3	Crimp	-		
		9243-1553-006	9243-9553-006	2	18.8	Clamp	-		
		9043-1533-006	-	1	19.3	Solder	-		
RG142 / RG223 / RG400	5/50/D	9243-1553-001	9243-9553-001	2	18.8	Clamp	-		
		9043-1533-001	-	1	19.3	Solder	-		
		9043-1523-001	9043-9523-001	1	19.3	Crimp	-		

Right Angle Plugs

RIGHT ANGLE PLUGS FOR SEMI-RIGID CABLES

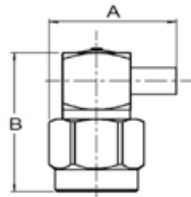

Fig. 1

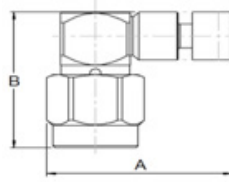

Fig. 2

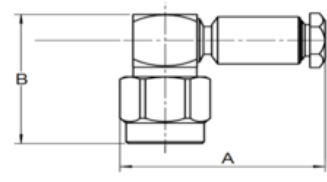
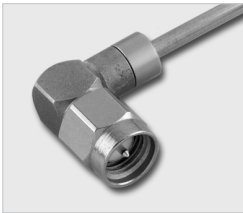

Fig. 3



Cable group	Cable group dia.	Part number (gold)	Part number (gold/passivated nut)	Fig.	Dimensions A (mm)	Dimensions B (mm)	Captive center contact	Assembly type
RG405	.085"	R125 153 000	R125 153 002	1	11.9	16.3	Yes	Solder type
RG402	.141"	R125 154 000	R125 154 002					
RG405	.085"	-	R125 153 901	2	15.7	15.8		Crimp type
RG402	.141"	-	R125 154 901					
RG405	.085"	9443-1563-010	-	1	12.2	17		Solder type
RG402	.141"	9443-1563-009	-					
RG405	.085"	9543-1593-010	9543-9593-010	3	18.8	17.5	Solder - Clamp	
RG402	.141"	9543-1593-009	9543-9593-009					

Straight Jacks

STRAIGHT JACKS FOR FLEXIBLE CABLES

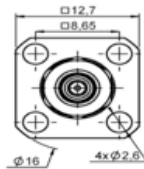

Fig. 1

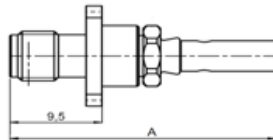

Fig. 2

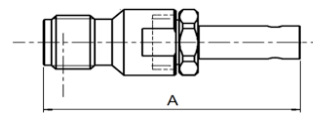

Fig. 3

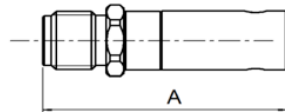
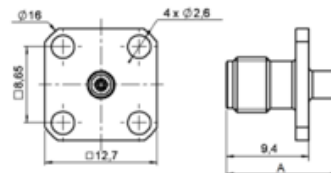

Fig. 4



Cable group	Cable group dia.	Part number (Gold)	Part number (Passivated)	Fig.	Dimensions A (mm)	Captive center contact	Panel drilling	Note
RG174 / RG316	2.6/50/S	R125 236 000	-	2	25.05	Yes	-	Crimp or solder
		R125 272 000	-	1	27.5		P03	Square flange
RG58 / RG141	5/50/S	R125 237 000	-	3	23.1	No	-	-
		R125 277 000	-	1	28.9		P03	Square flange
RG142 / RG223 / RG400	5/50/D	R125 238 000	-	3	23.1		-	-

## Straight Jacks

## STRAIGHT JACKS FOR FLEXIBLE CABLES (CONT'D)

Cable group	Cable group dia.	Part number (Gold)	Part number (Passivated)	Fig.	Dimensions A (mm)	Captive center contact	Panel drilling	Note
RG178 / RG196	2/50S	9002-1023-002	9002-9023-002	3	20.3	No	-	Crimp type
		9002-1033-002	-		20.3		-	Solder type
		9102-1573-002	9102-9573-002	2	27.9	Yes	-	Crimp type
		9031-1023-002	9031-9023-002	4	21	No	P03	Crimp type - Square flange
		9031-1033-002	-		21			Solder type - Square flange
		9131-1573-002	9131-9573-002	1	27.4	Yes		Crimp type - Square flange
RD178	2/50/D	9002-1023-005	9002-9023-005	3	20.3	No	-	Crimp type
		9002-1033-005	-				20.3	-
		9102-1573-005	9102-9573-005	2	27.9	Yes	-	Crimp type
		9031-1023-005	9031-9023-005	4	21	No	P03	Crimp type - Square flange
		9031-1033-005	-		21			Solder type - Square flange
		9131-1573-005	9131-9573-005	1	27.4	Yes		Crimp type - Square flange
RG174 / RG316	2.6/50S	9002-1023-003	9002-9023-003	3	20.3	No	-	Crimp type
		9002-1033-003	-				20.3	-
		9102-1573-003	9102-9573-003	2	27.9	Yes	-	Crimp type
		9031-1023-003	9031-9023-003	4	21	No	P03	Crimp type - Square flange
		9031-1033-003	-		21			Solder type - Square flange
		9131-1573-003	9131-9573-003	1	27.4	Yes		Crimp type - Square flange
RD316	2.6/50D	9002-1023-019	9002-9023-019	3	20.3	No	-	Crimp type
		9002-1033-019	-				20.3	-
		9102-1573-019	9102-9573-019	2	27.9	Yes	-	Crimp type
		9031-1023-019	9031-9023-019	4	21	No	P03	Crimp type - Square flange
		9031-1033-019	-		21			Solder type - Square flange
		9131-1573-019	9131-9573-019	1	27.4	Yes		Crimp type - Square flange
RG58 / RG141	5/50S	9002-1023-006	9002-9023-006	3	20.3	No	-	Crimp type
		9102-1573-006	9102-9573-006	2	27.9	Yes	-	Crimp type
		9002-1033-006	-	3	20.3	No	-	Solder type
		9031-1023-006	9031-9023-006	4	21		-	Crimp type - Square flange
		9031-1033-006	-			21	-	Solder type - Square flange
		9131-1573-006	9131-9573-006	1	27.4	Yes	-	Crimp type - Square flange
RG142 / RG223 / RG400	5/50D	9002-1033-001	-	3	20.3	No	-	Solder type
		9102-1573-001	9102-9573-001	2	27.9	Yes	-	Crimp type
		9031-1023-001	9031-9023-001	4	21	No	P03	Crimp type - Square flange
		9031-1033-001	-		21			Solder type - Square flange
		9131-1573-001	9131-9573-001	1	27.4	Yes		Crimp type - Square flange
		9002-1023-001	9002-9023-001	3	20.3	No	-	Crimp type

Straight Jacks

STRAIGHT JACKS FOR SEMI-RIGID CABLES

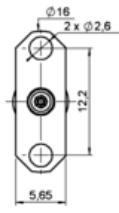

Fig. 1

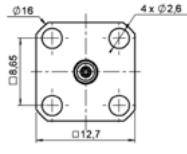

Fig. 2

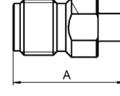
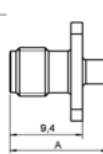

Fig. 3

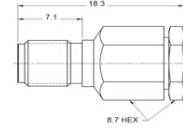

Fig. 4

Cable group	Cable group dia.	Part number (Gold)	Part number (Passivated)	Part number (Nickel)	Fig.	Dimensions	Captive center contact	Panel drilling	Note
						A (mm)			
RG405	.085"	R125 222 000	-	-	3	12.7	No	-	-
		R125 252 000	-	-	1			P02	2 hole flange
		R125 256 000	-	-	2			P03	Square flange
RG402	.141"	R125 225 000	-	-	3	12.7	No	-	-
		R125 251 000	-	-	1			P02	2 hole flange
		R125 255 000	-	-	2			P03	Square flange
RG405	.085"	9402-1083-010	-	9402-7083-010	3	15.2	Yes	-	Solder type
		9402-1583-010	-	9402-7583-010		12.7	No	-	
		9431-1083-010	-	9431-7083-010	2	13.9	No	P03	
		9431-1583-010	-	9431-7583-010			Yes / For one-step cable assembly		
		9441-1083-010	-	9441-7083-010	1	13.9	No	P02	
		9441-1583-010	-	9441-7583-010			Yes / For one-step cable assembly		
9502-1593-010	9502-9593-010	-	4	-	Yes	-	Solder - Clamp type		
RG402	.141"	9402-1083-009	-	9402-7083-009	3	12.7	No	-	Solder type
		9402-1583-009	-	9402-7583-009			Yes / For one-step cable assembly		
		9431-1083-009	-	9431-7083-009	2	13.9	No	P03	
		9431-1583-009	-	9431-7583-009			Yes / For one-step cable assembly		
		9441-1083-009	-	9441-7083-009	1	13.9	No	P02	
		9441-1583-009	-	9441-7583-009			Yes / For one-step cable assembly		
9502-1593-009	9502-9593-009	-	4	-	Yes	-	Solder - Clamp type		

Bulkhead Jacks

STRAIGHT BULKHEAD JACKS FOR FLEXIBLE CABLES (rear mount)

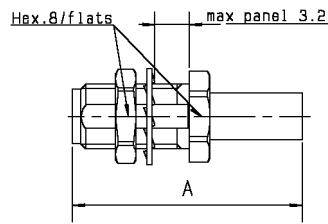

Fig. 1

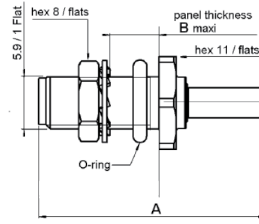

Fig. 2

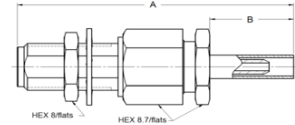
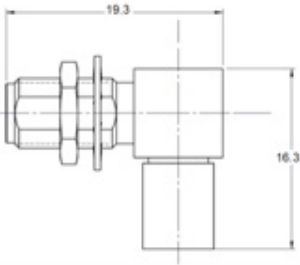

Fig. 3

Cable group	Cable group dia.	Part number (Gold)	Part number (Passivated)	Fig.	Dimensions (mm)		Captive center contact	Panel drilling	Note
					A	B			
RG178 / RG196	2/50/S	R125 320 020	-	2	26.1	5.6			Totally waterproof
RG174 / RG316	2.6/50/S	R125 303 000	R125 303 001	1	25.7	-			Crimp and solder Heatshrink sleeve
		R125 312 120	-	2	22.4	-			Full crimp
RD316	2.6/50/D	R125 321 020	-	2	23.7	3.2			Totally waterproof
		R125 313 120	-	1	22.4	-	Yes		Full crimp
RG58 / RG141	5/50/S	R125 322 030	-	2	22.4	3.2			Panel sealed
		R125 314 120	-	1	25.4	-			Full crimp
RG142 / RG223 / RG400	5/50/D	R125 315 120	-	1	29.6	-			Crimp and solder
		R125 308 000	-						
RG178 / RG196	2/50/S	9030-1023-002	9030-9023-002		23.9	-	No		Crimp type
		9030-1033-002	-						Solder type
		9130-1573-002	9130-9573-002	3	30.5	9.5	Yes		Crimp type
		9230-1553-002	9230-9553-002		21	0			Clamp type
RD178	2/50/D	9030-1023-005	9030-9023-005	1	23.9	-	No	P06	Crimp type
		9030-1033-005	-						Solder type
		9130-1573-005	9130-9573-005	3	30.5	9.5	Yes		Crimp type
		9230-1553-005	9230-9553-005		21	0			Clamp type
RG174 / RG316	2.6/50/S	9030-1023-003	9030-9023-003	1	23.9	-	No		Crimp type
		9030-1033-003	-						Solder type
		9130-1573-003	9130-9573-003	3	30.5	9.5	Yes		Crimp type
		9230-1553-003	9230-9553-003		21	0			Clamp type
RD316	2.6/50/D	9030-1023-019	9030-9023-019	1	23.9	-	No		Crimp type
		9030-1033-019	-						Solder type
		9130-1573-019	9130-9573-019	3	30.5	9.5	Yes		Crimp type
		9230-1553-019	9230-9553-019		21	0			Clamp type
RG58 / RG141	5/50/S	9030-1023-006	9030-9023-006	1	23.9	-	No		Crimp type
		9030-1033-006	-						Solder type
		9130-1573-006	9130-9573-006	3	30.5	9.5	Yes		Crimp type
		9230-1553-006	9230-9553-006		21	0			Clamp type
RG142 / RG223 / RG400	5/50/D	9030-1023-001	9030-9023-001	1	23.9	-	No		Crimp type
		9030-1033-001	-						Solder type
		9130-1573-001	9130-9573-001	3	30.5	9.5	Yes		Crimp type
		9230-1553-001	9230-9553-001		21	0			Clamp type

Bulkhead Jacks

**RIGHT ANGLE BULKHEAD JACKS CRIMP TYPE FOR FLEXIBLE CABLES (rear mount)**



Cable group	Cable group dia.	Part number (Gold)	Part number (Passivated)	Captive center contact	Panel drilling	Note
RG178 / RG196	2/50S	9613-1523-002	9613-9523-002	Yes	P06	Crimp type
RD178	2/50D	9613-1523-005	9613-9523-005			
RG174 / RG316	2.6/50S	9613-1523-003	9613-9523-003			
RD316	2.6/50D	9613-1523-019	9613-9523-019			
RG58 / RG141	5/50S	9613-1523-006	9613-9523-006			
RG142 / RG223 / RG400	5/50D	9613-1523-001	9613-9523-001			

**BULKHEAD JACKS SOLDER TYPE FOR SEMI-RIGID CABLES (rear mount)**

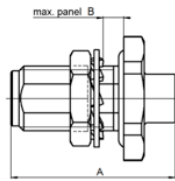
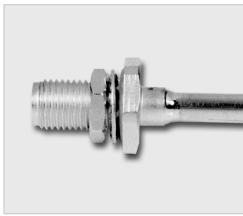

Fig. 1

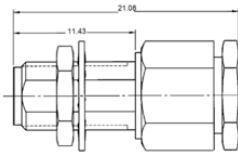

Fig. 2

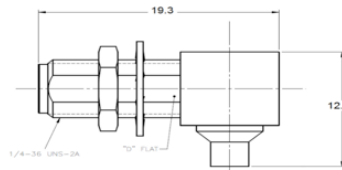

Fig. 3

Cable group	Cable group dia.	Part number (Gold)	Part number (Nickel)	Part number (Passivated)	Fig.	Dimensions A (mm)	Dimensions B (mm)	Captive center contact	Panel drilling	Note
RG405	.085"	R125 326 000	-	-	1	16	2.4	No	P06	Panel sealed
RG402	.141"	R125 325 000	-	-		17.1	3.5			Unsealed
		R125 305 000	-	-		17.8				Panel sealed
RG405	.085"	9453-1083-010	9453-7083-010	-	3	19.3	3.2	Yes	-	Solder type
		9613-1563-010	9613-9563-010	-						
		9453-1583-010	9453-7583-010	-	1	17.8		Yes / for one-step cable assembly	P06	Panel sealed
9530-1593-010	-	9530-9593-010	2	-	Yes			Solder - Clamp		
RG402	.141"	9453-1583-009	9453-7583-009	-	1	17.8		Yes / for one-step cable assembly	P06	Panel sealed
		9530-1593-009	-	9530-9593-009	2	-		Yes		Solder - Clamp
		9453-1083-009	9453-7083-009	-	1	17.8		No		Panel sealed
		9613-1563-009	9613-9563-009	-	3	19.3		Yes	-	Solder type



Receptacles

STRAIGHT FEMALE FLANGE RECEPTACLES - SOLDER POT

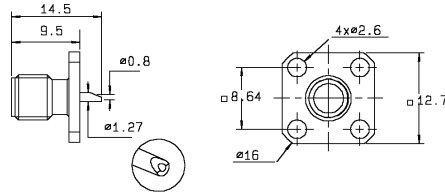
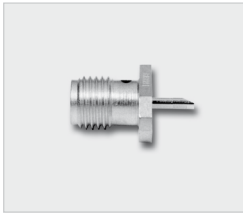

Fig. 1

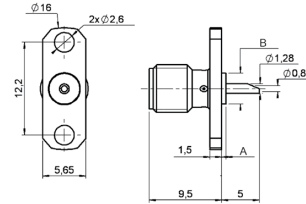

Fig. 2

Part number (Gold)	Part number (Passivated)	Fig.	Dimensions (mm)		Captive center contact	Panel drilling	Note
			A	B			
R125 403 000	R125 403 001	1	-	-	Yes (4 indents)	P04	Square flange
R125 453 000	-	2	0.6	$\phi 4.06$		Yes	P01
R125 454 000	R125 454 001		-	-			
9408-1113-000	9408-9113-000		0.8	-			
9408-1113-002	9408-9113-002	0	-		P02		

STRAIGHT AND RIGHT ANGLE FEMALE SQUARE FLANGE RECEPTACLES - SOLDER POT

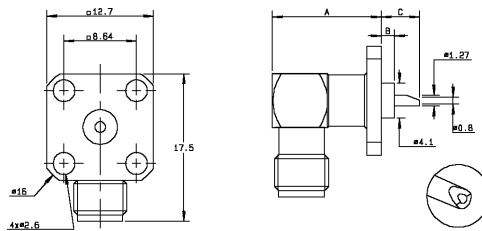

Fig. 1

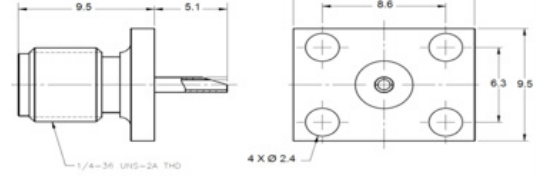

Fig. 2

Part number (Gold)	Part number (Passivated)	Fig.	Dimensions (mm)			Captive center contact	Panel drilling
			A	B	C		
-	R125 653 001	1	12.4	1.57	4.6	Yes	P04
R125 654 000	-		11.1	0	6.1		
9424-1513-000	9424-9513-000		12.7	1.6	4.8		P03
9425-1513-000	9425-9513-000		9.1				
9407-1113-000	9407-9113-000	2	-	-	-		

Receptacles

**BULKHEAD FEMALE RECEPTACLE (solder pot)**

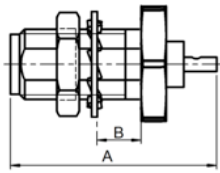

Fig. 1

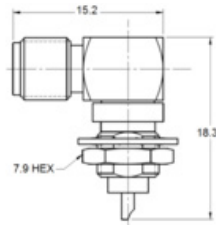

Fig. 2

Part number (Gold)	Part number (Passivated)	Fig.	Dimensions A (mm)	Dimensions B (mm)	Captive center contact	Panel drilling	Note
R125 553 000	R125 553 001	1	17.4	3.4	Yes (2 indents)	P06	Rear mount
9412-1113-000	9412-9113-000		17.0	3.2	Yes		-
9422-1113-000	9422-9113-000						Front mount
9432-1113-000	9432-9113-000						Rear mount, panel sealed
9609-1513-000	9609-9513-000	2	-	-	-	-	Right angle front mount

**SCREW-ON FEMALE RECEPTACLES (front mount)**

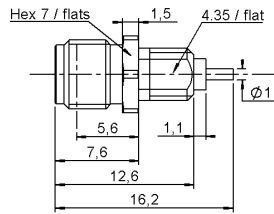

Fig. 1

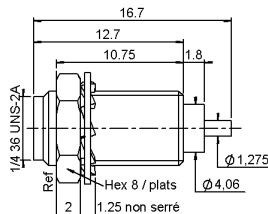

Fig. 2

Part number (gold)	Fig.	Captive center contact	Note
R125 555 500	1	Yes	Screw-on
R125 560 000	2		

**STRAIGHT MALE FLANGE RECEPTACLES (solder pot)**

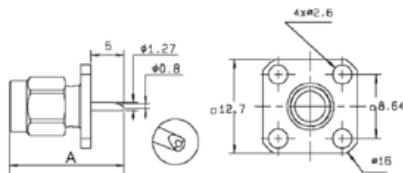

Fig. 1

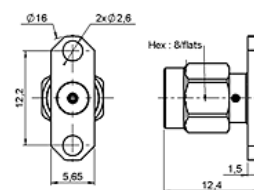
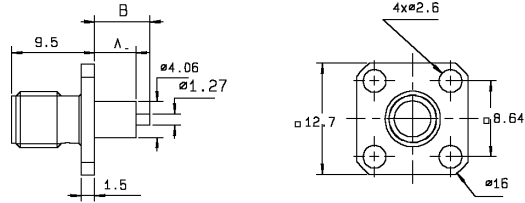
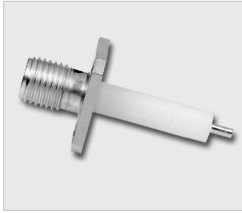

Fig. 2

Part number (Gold)	Fig.	Captive center contact	Dimensions A (mm)	Panel drilling	Note
R125 433 000	1	Yes (4 indents)	17.4	P04	Square flange
R125 483 000	2			P01	2 hole flange
9404-1113-000	1	Yes	14.5	P03	1/2" Square flange
9476-1113-000				P11	3/8" Square flange

Receptacles

**SQUARE FLANGE EXTENDED DIELECTRIC FEMALE RECEPTACLES**



Part number (Gold)	Part number (Passivated)	Dimensions (mm)		Captive center contact	Panel drilling
		A	B		
R125 413 000	R125 413 001	12.7	15.9	No	P04
R125 414 000	R125 414 001			Yes (epoxy)	
R125 414 004	-			Yes (4 indents)	
R125 415 000	R125 415 001	18	20.5	Yes (epoxy)	
R125 415 030	-	3.2	5.4	Yes (4 indents)	
R125 415 275	-	15	17.9	Yes (4 indents)	
R125 415 270	R125 415 271			Yes (epoxy)	
R125 416 460	-	4	8	Yes (epoxy)	
9004-1113-000	9004-9113-000	14.9	3	Yes (4 indents)	P11
9004-1213-000	-			Yes (square flange)	
-	9076-9113-000			Yes (4 incidents)	
-	9007-9113-000				

**2 HOLE FLANGE EXTENDED DIELECTRIC FEMALE RECEPTACLES**

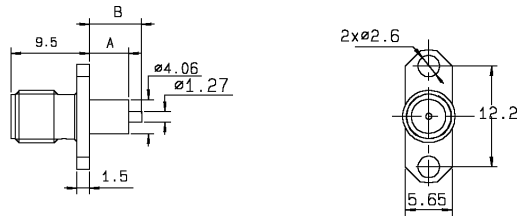
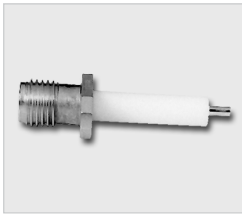

Part number (Gold)	Part number (Passivated)	Dimensions (mm)		Captive center contact	Panel drilling
		A	B		
R125 464 000	R125 464 001	12.7	15.9	Yes (epoxy)	P01
R125 464 270	R125 464 271	15	17.9	Yes (4 indents)	
R125 464 274	-			Yes (4 indents)	
9008-1113-000	-	14.98	24.32	No	
9008-1213-000	-			Yes (4 indents)	
-	9008-9113-000				

**RIGHT ANGLE FEMALE SQUARE FLANGE EXTENDED DIELECTRIC RECEPTACLES**

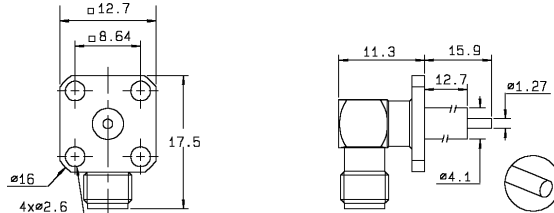
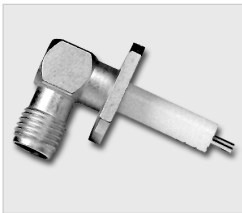

Part number (Gold)	Part number (Passivated)	Captive center contact	Panel drilling
R125 654 450	R125 654 451	Yes	P04

Receptacles

STRAIGHT MALE FLANGE EXTENDED DIELECTRIC RECEPTACLES

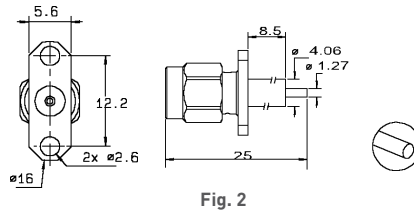
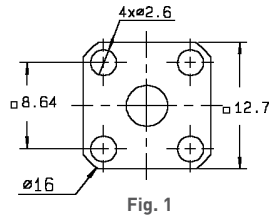
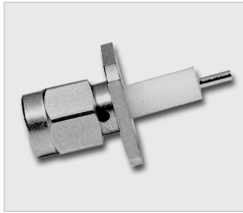

Part number (Gold)	Part number (Passivated)	Fig.	Captive center contact	Panel drilling	Note
R125 444 000	R125 444 001	1	Yes (epoxy)	P04	Square flange
R125 474 000	R125 474 001	2		P01	2 hole flange

PCB FEMALE RECEPTACLES

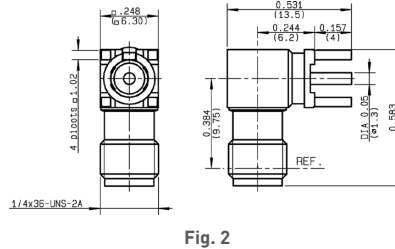
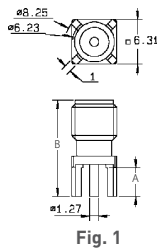

Part number (Gold)	Fig.	Dimensions (mm)		Captive center contact	PCB pattern	Note
		A	B			
R125 426 000	1	4	13.5	Yes	P05	-
R125 426 140		6.9	14.4			Selective tin plating
R125 680 000	2	-	-	-	-	-

STRAIGHT FEMALE SQUARE FLANGE RECEPTACLES - TAB CONTACT

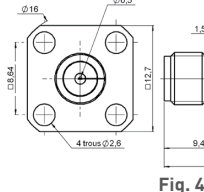
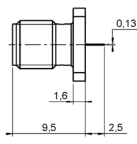
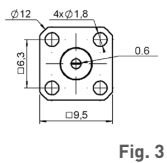
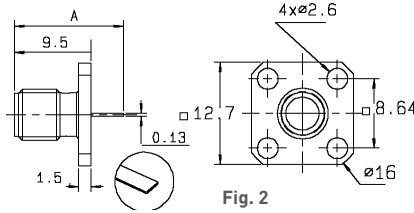
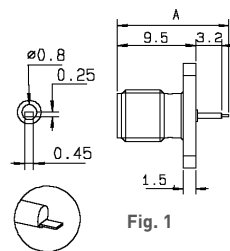
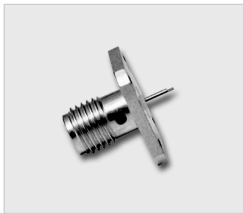

Fig. 4

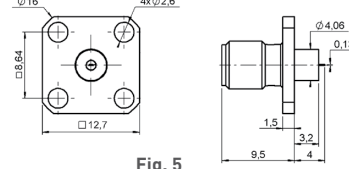

Fig. 5

Part number (Gold)	Part number (Passivated)	Fig.	Dimensions A (mm)	Captive center contact	Panel drilling	Contact type
R125 501 000	R125 501 001	1	13.5	Yes (epoxy)	P04	Offset tab
R125 510 000	R125 510 001	2	12		P11	
R125 510 500	R125 510 501	3	2.5		Tab	
R125 612 120	-	4	-			P04
R125 620 000	-	2	10.38			P04
R125 622 000	-	5	-		P11	
-	R125 943 001	3	0.89			

Receptacles

STRAIGHT AND RIGHT ANGLE FEMALE 2 HOLE FLANGE RECEPTACLES - TAB CONTACT

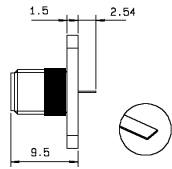

Fig. 1

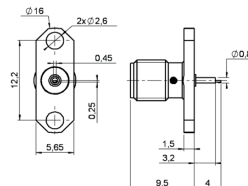
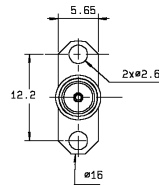

Fig. 2

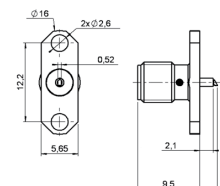

Fig. 3

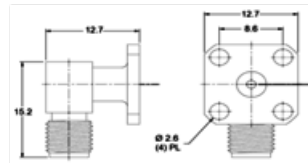

Fig. 4

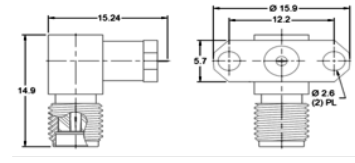
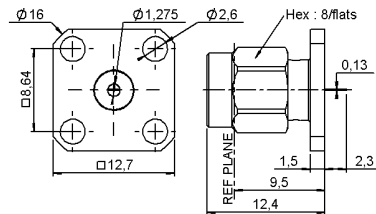

Fig. 5

Part number (Gold)	Part number (Passivated)	Fig.	Captive center contact	Panel drilling	Contact type
R125 451 000	-	2	Yes (epoxy)	P01	Offset tab
R125 452 000	-	3			Special
R125 497 000	-	1			Tab
9124-1513-000	9124-9513-000	4	Yes	P03	Tab contact 1.3mm width
9126-1513-000	9126-9513-000	5		P01	

STRAIGHT MALE SQUARE FLANGE RECEPTACLES - TAB CONTACT



Part number (Gold)	Part number (Passivated)	Captive center contact	Panel drilling	Note
R125 488 000	R125 488 001	Yes (epoxy)	P04	Unit packaging

STRAIGHT FEMALE SQUARE FLANGE RECEPTACLES - CYLINDRICAL CONTACT

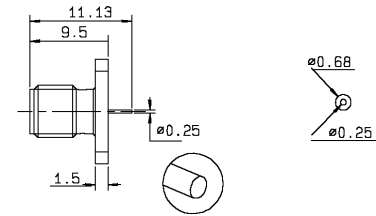
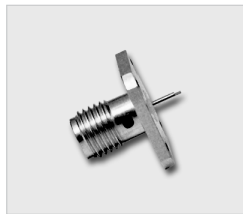

Part number (Gold)	Captive center contact	Panel drilling	Note
R125 610 000	Yes (epoxy)	P04	Unit packaging

Receptacles for Microstrip

STRAIGHT FEMALE FLANGE RECEPTACLES - CYLINDRICAL CONTACT

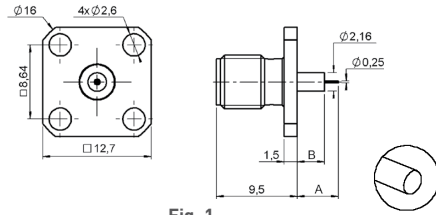

Fig. 1

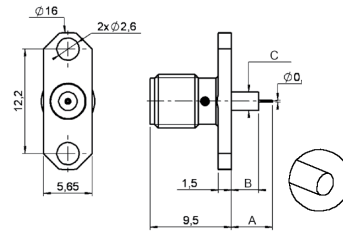

Fig. 2

Part number (Gold)	Part number (Passivated)	Fig.	Dimensions (mm)			Captive center contact	Panel drilling	Note	Captive
			A	B	C				
R125 512 000	R125 512 001	1	4.8	3.2	-	Yes	P04	Square flange	4 indents
R125 513 000	-		3.2	1.6	-				Epoxy
R125 462 000	R125 462 001	2	4.8	3.2	2.16		P01	2 hole flange	Epoxy
R125 463 000	-		3.2	1.6	2.16				
-	R125 617 001		4.8	3.2	4.06				

STRAIGHT MALE FLANGE RECEPTACLES - CYLINDRICAL CONTACT

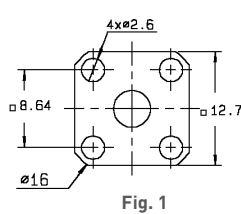

Fig. 1

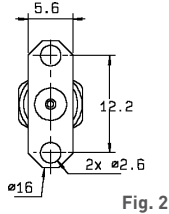
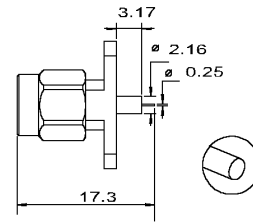

Fig. 2



Part number (Gold)	Part number (Passivated)	Fig.	Captive center contact	Panel drilling	Note
R125 492 000	R125 492 001	1	Yes (epoxy)	P04	Square flange
R125 484 000	R125 484 001	2		P01	2 hole flange

Receptacles for Microstrip

**UNIVERSAL FIELD-REPLACEABLE RECEPTACLES - FEMALE SOCKET**  
(accept pin 0.93 mm [.037"])

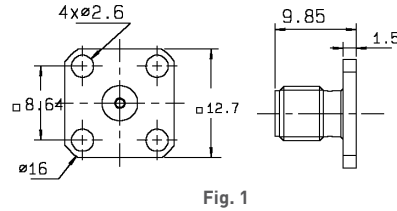

Fig. 1

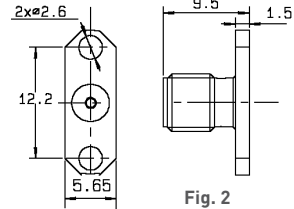

Fig. 2

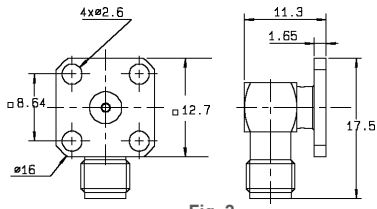

Fig. 3

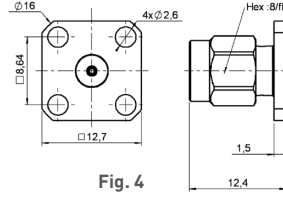

Fig. 4

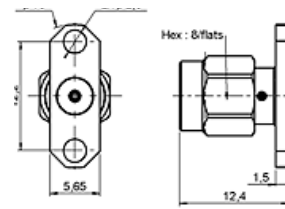

Fig. 5

Part number (Gold)	Part number (Passivated)	Fig.	Captive center contact	Panel drilling	Note
R125 410 000	R125 410 001	1	Yes (epoxy)	P04	Female - Square flange
-	R125 430 001	4			Male - Square flange
R125 460 000	R125 460 001	2		P01	Female - 2 hole flange - Unit packaging
-	R125 480 001	5			Male - 2 hole flange
-	R125 670 001	3	-	P04	Female - Right angle square flange

**EDGE CARD RECEPTACLES**

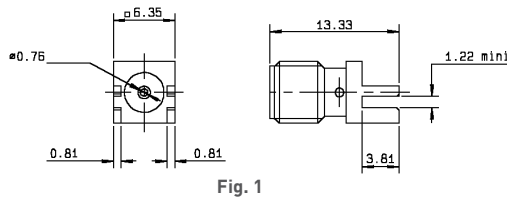
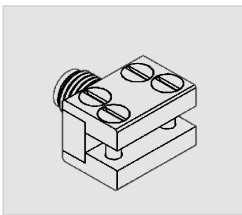

Fig. 1

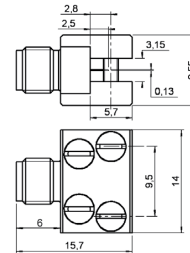
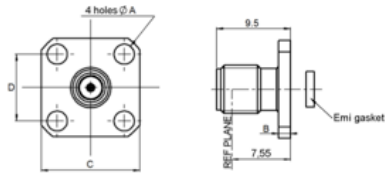
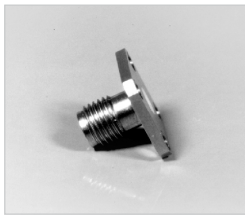

Fig. 2

Part number (Gold)	Part number (Passivated)	Fig.	Captive center contact	Note	Captivation
R125 423 200	-	1	Yes	Solder pins	4 indents
R125 541 000	R125 541 001	2		4 screws	Epoxy

Hermetic Receptacles with Separate Glass Bead

**SQUARE FLANGE 12.7 mm FEMALE RECEPTACLE**



Part number (Gold)	Part number (Passivated)	Glass bead only	Dimensions (mm)				EMI gasket only	Panel drilling connector	Panel drilling glass bead	Note
			A	B	C	D				
R125 411 000	R125 411 001	R280 751 000	2.6	1.5	12.7	8.6	R280 510 000	P10	P13	Diameter pin = 0.30
9074-9513-000	-	-	1.7	1.6	9.5	6.3	-			Diameter pin = 0.45
9079-9513-000	-	-	-	-	-	-	-			Diameter pin = 0.30
9079-9513-001	-	-	-	-	-	-	-			Diameter pin = 0.38

**NARROW FLANGE FEMALE RECEPTACLES**

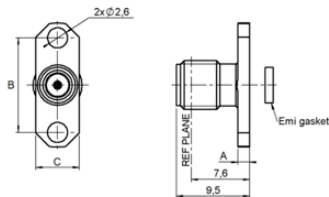
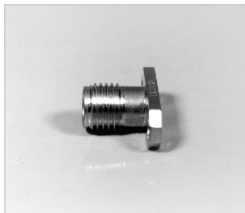

Part number (Gold plated)	Part number (Passivated)	Glass bead only	Dimensions (mm)			EMI gasket only	Panel drilling connector	Panel drilling glass bead	Note
			A	B	C				
R125 465 000	R125 465 001	R280 751 000	1.5	12.2	5.6	R280 510 000	P12	P13	-
R125 465 010	R125 465 011	R280 757 070					P18	-	-
-	9080-9513-000	920-55	1.6	10.2	4.7	No EMI gasket	-	-	Diameter Pin = 0.30
-	9180-9513-000	920-55 (included)					-	-	-
-	9180-9513-001	920-82 (included)					-	-	-
-	9144-9513-000	920-55 (included)	12.2	5.7	Contact Us	P12	-	-	Diameter Pin = 0.38

**NARROW FLANGE MALE RECEPTACLES**

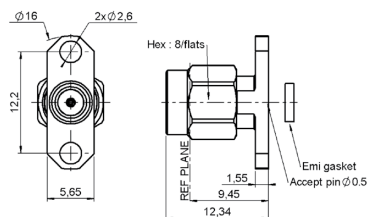

Part number (Passivated)	Glass bead only	EMI gasket only	Panel drilling connector	Panel drilling glass bead
R125 481 001	R280 751 000	R280 510 000	P12	P13
R125 481 011	R280 757 070			P18
9050-9513-000	920-56	Contact Us		-



Hermetic Receptacles with Integrated Glass Bead

SCREW-ON TYPE FEMALE RECEPTACLES

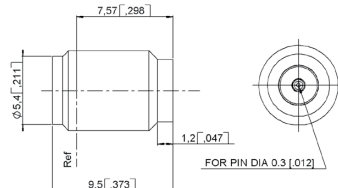
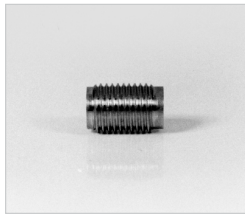

Fig. 1

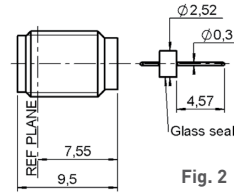
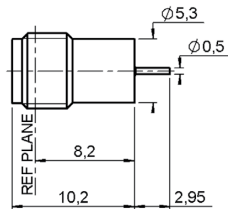

Fig. 2

Part number (Passivated)	Glass bead only	Fig.	Assembly tool	Panel drilling glass bead	Note
R125 556 001	R280 751 000	1	R282 341 010	P15	For pin dia 0.3/0.12
R125 556 011	R280 755 000			P19	For pin dia 0.5/0.19
R125 638 001	R280 751 350	2		P15	Supplied with glass bead

SOLDER TYPE FEMALE RECEPTACLE

Panel feedthrough receptacles feature an internal hermetic glass bead. A ring of solder between the receptacle body and the package will provide the hermeticity level.



Part number (Gold)	Connector body	Panel drilling	Contact type
R125 630 000	FN42 alloy	-	Cylindrical
R125 630 040	Stainless steel		

SCREW-ON TYPE FEMALE RECEPTACLE

Screw-on receptacles with integrated glass seal - the compression gasket will ensure the hermeticity between the receptacle and the package.

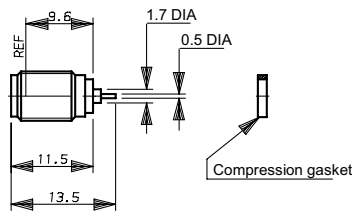

Part number (Gold)	Part number (Passivated)	Connector body	Panel drilling	Contact type
R125 609 000	R125 609 001	Stainless steel	P05	Cylindrical

SCREW-ON TYPE FEMALE RECEPTACLE WITH SLIDING CONTACT

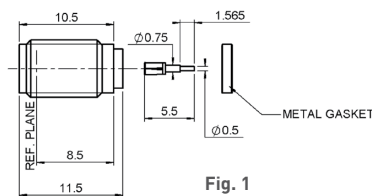
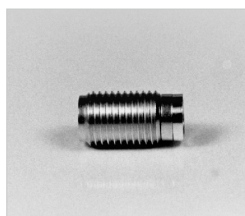

Fig. 1

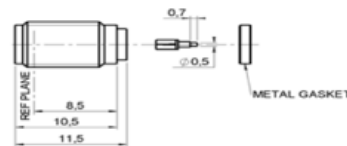

Fig. 2

Part number (Passivated)	Fig.	Connector body	Panel drilling	Contact type
R125 609 031	1	Stainless steel	P05	Cylindrical
R125 609 011	2			

Hermetic Receptacles without Glass Bead

SCREW-ON TYPE FEMALE RECEPTACLE WITH SLIDING CONTACT

Screw-on receptacles without glass bead provide a lower hermeticity level (10<sup>-6</sup>atm/cm<sup>3</sup>/sec). A gasket is provided to guarantee the hermeticity between the receptacle and the package.

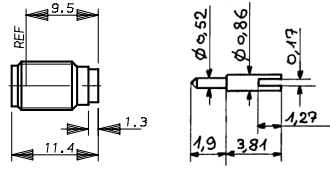

Part number (Gold)	Part number (Passivated)	Panel drilling	Contact type
R125 605 300	R125 605 301	P08	Slotted

Adapters

IN SERIES ADAPTERS

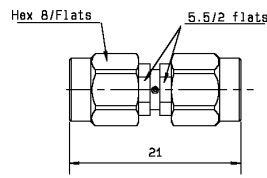

Fig. 1

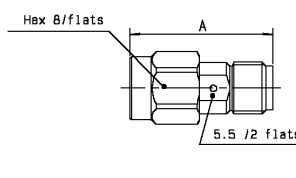

Fig. 2

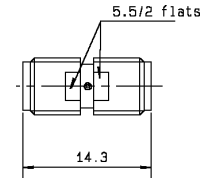

Fig. 3

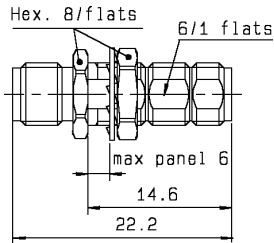

Fig. 4

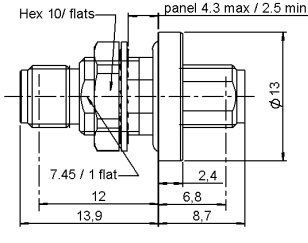

Fig. 5

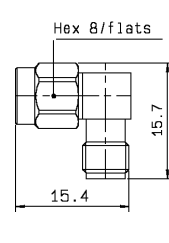

Fig. 6

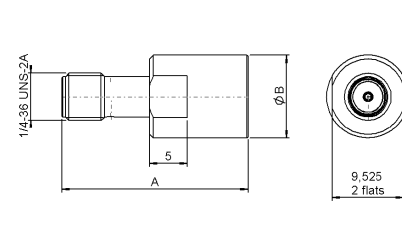

Fig. 7

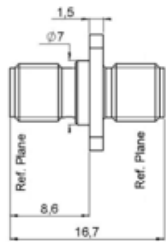

Fig. 8

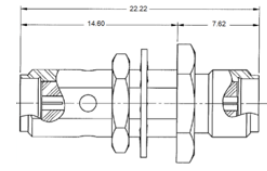
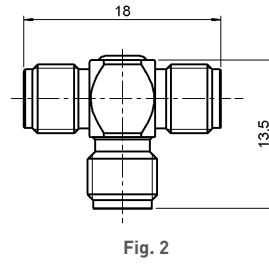
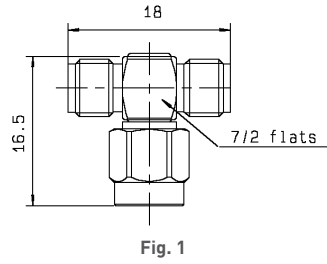

Fig. 9

Part number (Gold)	Part number (Passivated)	Fig.	Dimensions (mm)		Captive center contact	Panel drilling	Note
			A	B			
R125 703 000	R125 703 001	1	-	-	-	-	Male - Male
R125 704 000	R125 704 001	2	17.5	-	Yes (4 indents)	-	Male - Female
R125 705 000	R125 705 001	3	-	-	-	-	Female - Female
R125 720 000	R125 720 001	4	-	-	Yes (epoxy)	P06	Bulkhead female - Female
R125 753 000	R125 753 001	5	-	-	Yes	P08	Bulkhead hermetically sealed Female - Female
R125 771 000	R125 771 001	6	-	-	-	-	Right angle male - Female
-	R125 791 501	7	23.3	8.9	Yes (epoxy)	-	Push-on male
-	R125 792 501		24.8	11		P07	Push-on female
-	R125 710 021		-	-		P06	Female - Female square flange adapter
5909-1103-000	5909-9103-000	9	-	-	-	-	Bulkhead female - Female
5916-1103-603	5916-9103-603	2	17.4	-	-	-	Male - Female
5917-1103-000	5917-9103-000	3	-	-	-	-	Female - Female
5918-1103-000	5918-9103-000	1	-	-	Yes (4 indents)	-	Male - Male
5919-1503-000	5919-9503-000	6	-	-	-	-	Male - Female / Right angle
5919-1503-001	5919-9503-001		-	-	-	-	Male - Male / Right angle
5919-1503-003	5919-9503-003		-	-	-	-	Male - Male / Right angle

## Adapters

### TEE IN SERIES ADAPTERS



Part number (Gold)	Part number (Passivated)	Fig.	Type	Captive center contact
R125 780 000	R125 780 001	1	Male / Female - Female	Yes
R125 781 000	R125 781 001	2	Female / Female - Female	

## Accessories

### MALE AND FEMALE CAPS

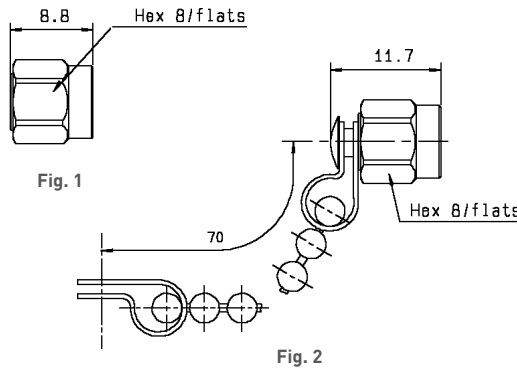

Part number (Gold)	Part number (Passivated)	Fig.	Note
R125 802 000	R125 802 001	1	Male
R125 812 000	R125 812 001	2	Male with chain
R125 852 000	R125 852 001	1	Male short circuit
R125 845 000	R125 845 001	3	Female with cord

### CENTER CONTACTS (To be used with universal receptacle)

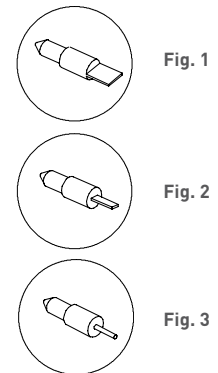
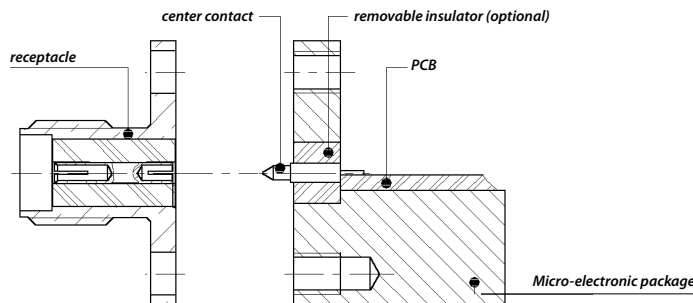
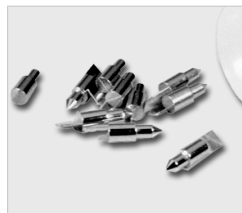

Part number	Fig.	Termination	Dimensions (mm)			Packaging
			A	B	C	
R280 461 000	1	Tab	3.37	0.13	1.6	10 pieces
R280 461 200	2	Tab special	3.37	0.13 x W0.51	1.6	
R280 461 210	1	Tab	10.3	0.13	1.6	
R280 462 000	3	Cylindrical	1.77	dia 0.25	1.57	
R280 463 000	3	Cylindrical	3.37	dia 0.25	1.57	
R280 465 000	2	Tab special	0.2	0.13 x W0.60	0.9	

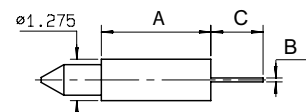

Glass Beads

GLASS BEADS FOR HERMETIC RECEPTACLES

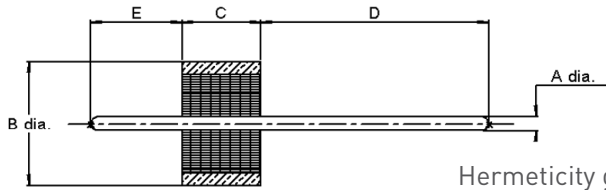
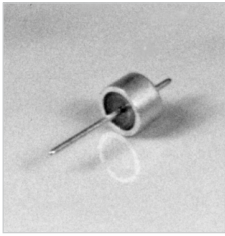

Hermeticity guaranteed at  $10^{-8}$  atm.cm<sup>3</sup>/s

Part number	Dimensions mm (inch)					Packaging
	A	B	C	D	E	
R280 751 000	0.30 (.012)	2.52 (.099)	1.60 (.063)	4.57 (.180)	1.83 (.072)	1
R280 751 080				1.3 (.051)		100
R280 751 350				4.57 (.180)		1
R280 752 000	0.38 (.015)	2.50 (.098)	1.56 (.061)	1.95 (.076)	1.59 (.062)	100
R280 752 020				1.3 (.051)		
R280 755 000	0.46 (.018)	2.85 (.112)	1.60 (.063)	4.57 (.180)	-	1
R280 755 040		2.85 (.111)				
R280 757 070	0.50 (.019)	4 (.157)	1.77 (.070)	1.78 (.070)	2.03 (.080)	100
R280 757 080				5.82 (.230)	1.93 (.076)	1

Go to page 17-18 for more glass beads.

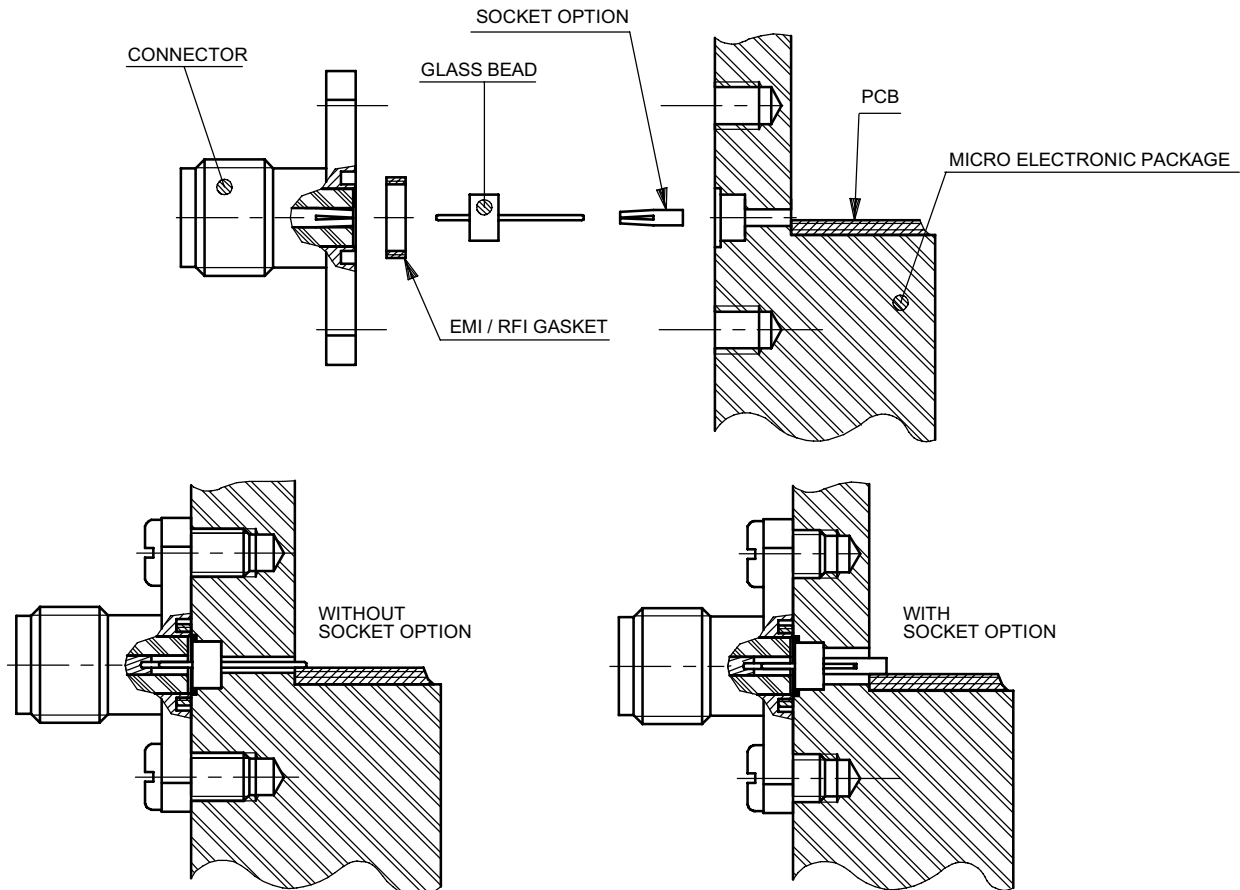

## Accessories for Hermetic Microstrip Receptacles

### OPTIONAL SOCKET

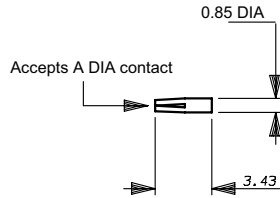

Part number	A Dia (mm)	Packaging
R280 469 000	0.30	10 pieces
R280 469 010	0.46	

Go to chapter 19-A for more socket contact options.

For use with glass seal.

### Panel Drilling

#### P01

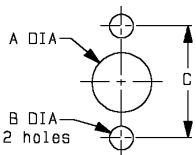

	MM		INCH	
	maxi	mini	maxi	mini
A	4.2	4.1	0.165	0.161
B	2.7	2.6	0.106	0.102
C	12.25	12.15	0.482	0.478

#### P02

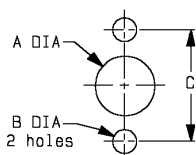

	MM		INCH	
	maxi	mini	maxi	mini
A	6.6	6.5	0.26	0.256
B	2.7	2.6	0.106	0.102
C	12.25	12.15	0.482	0.478

#### P03

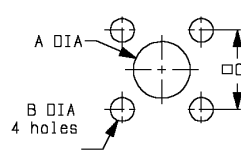

	MM		INCH	
	maxi	mini	maxi	mini
A	6.6	6.5	0.26	0.256
B	2.7	2.6	0.106	0.102
C	8.69	8.59	0.342	0.338

#### P04

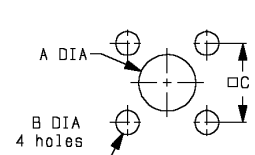

	MM		INCH	
	maxi	mini	maxi	mini
A	4.3	4.2	0.169	0.165
B	2.7	2.6	0.106	0.102
C	8.69	8.59	0.342	0.338

#### P05

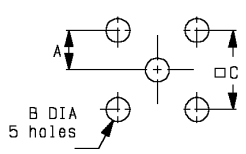

	MM		INCH	
	maxi	mini	maxi	mini
A	2.59	2.49	0.102	0.098
B	1.7	1.6	0.067	0.063
C	5.13	5.03	0.202	0.198

#### P06

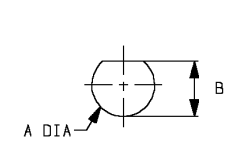

	MM		INCH	
	maxi	mini	maxi	mini
A	6.5	6.4	0.256	0.252
B	6.14	6	0.242	0.236

#### P07

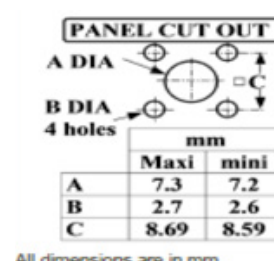

All dimensions are in mm.

#### P08

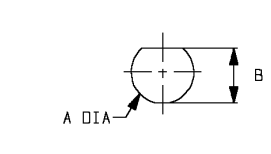

	MM		INCH	
	maxi	mini	maxi	mini
A	8.1	8	0.319	0.315
B	7.6	7.5	0.299	0.295

#### P09

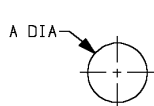

	MM		INCH	
	maxi	mini	maxi	mini
A	5.2	5.16	0.205	0.203

#### P10

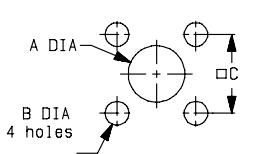

	MM		INCH	
	maxi	mini	maxi	mini
A	4.2	4.1	0.165	0.161
B	2.7	2.6	0.106	0.102
C	8.69	8.59	0.342	0.338

#### P11

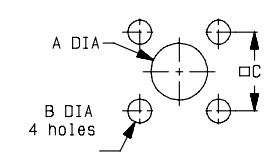

	MM		INCH	
	maxi	mini	maxi	mini
A	4.2	4.1	0.165	0.161
B	1.9	1.8	0.071	0.067
C	6.4	6.3	0.252	0.248

#### P12

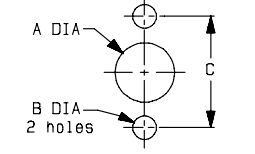

	MM		INCH	
	maxi	mini	maxi	mini
A	4.2	4.1	0.165	0.161
B	2.7	2.6	0.106	0.102
C	12.25	12.15	0.482	0.478

Panel Drilling

HERMETIC SEPARATE GLASS BEAD RECEPTACLES

P13/14

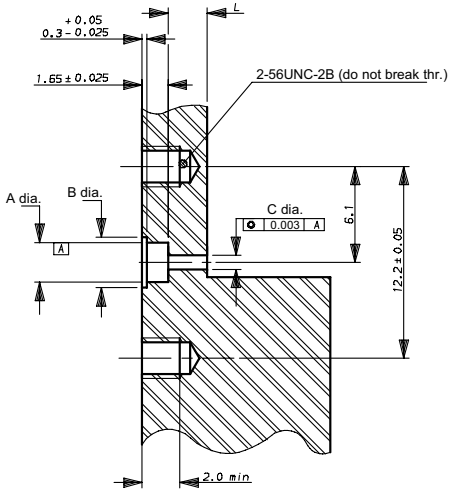

	P13	P14
A dia.	2.6±0.025	2.92±0.025
B dia.	3.23±0.025	3.55±0.025
C dia. (1)	2±0.02	
C dia. (2)	0.7±0.02	1.08±0.02
L dia. (1)	2.5±0.1	
L dia. (2)	from 1 mm to 4 mm	

- (1) Using of the removable contact.
- (2) The pin is directly welded on the trace.

P15/16

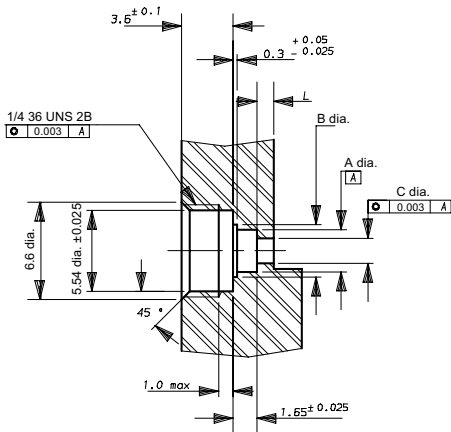

	P15	P16
A dia.	2.6±0.025	2.92±0.025
B dia.	3.23±0.025	3.55±0.025
C dia. (1)	2±0.02	
C dia. (2)	0.7±0.02	1.08±0.02
L dia. (1)	2.5±0.1	
L dia. (2)	from 1 mm to 4 mm	

- (1) Using of the removable contact.
- (2) The pin is directly welded on the trace.

P17

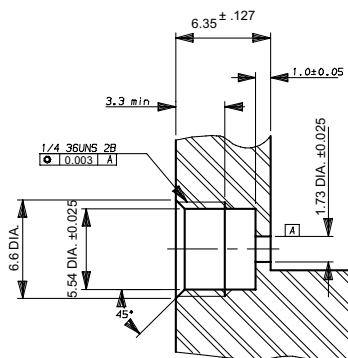

P18

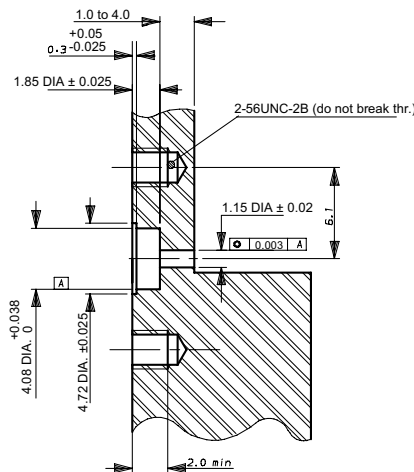

Panel Drilling

HERMETIC SEPARATE GLASS BEAD RECEPTACLES

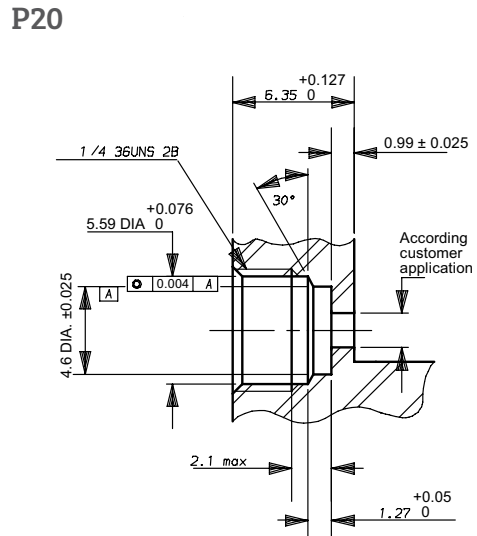
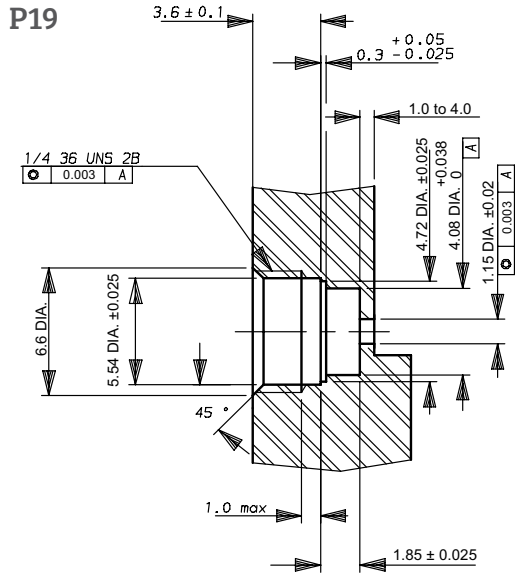

Tooling for Hermetic Receptacles

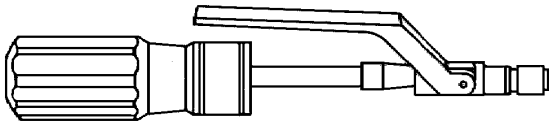

Coupling torque: 190 cm N

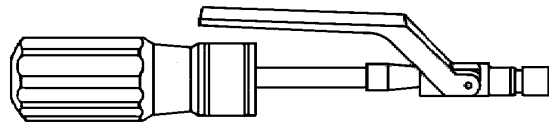

Coupling torque: 280 cm N

Part number	Description
R282 341 010	Installation tool for jack receptacles R125 556 000 R125 556 001 R125 556 010 R125 556 011

Part number	Description
R282 341 012	Installation tool for jack receptacles R125 605 361 R125 605 371 R125 605 401 R125 609 000 R125 609 001 R125 609 010 R125 609 011 R125 609 070 R125 609 071

## Field Replaceable Hermetic Microstrip Receptacle Information

## ELECTRICAL PERFORMANCE

## V.S.W.R. to 18 GHz

Connector only	Seal only	Connector & seal
1.04 + 0.006F (GHz)	1.02 + 0.003F (GHz)	1.06 + 0.01F (GHz)

## V.S.W.R. MEASUREMENT

## Setting for V.S.W.R. measurement on field replaceable hermetic receptacle

## a) Measurement with auxiliary contact-assembly drawing

R280 469 000 (for pin DIA 0.30 mm)  
R280 469 010 (for pin DIA 0.46 mm)

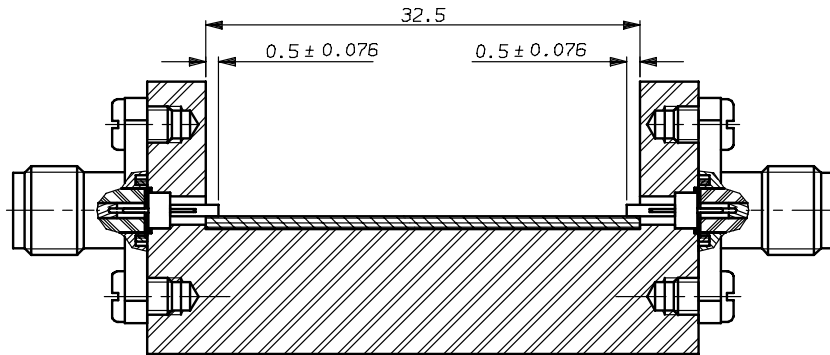

## b) Measurement without auxiliary contact-assembly drawing

Recommended value : L1 = 1.0 mm

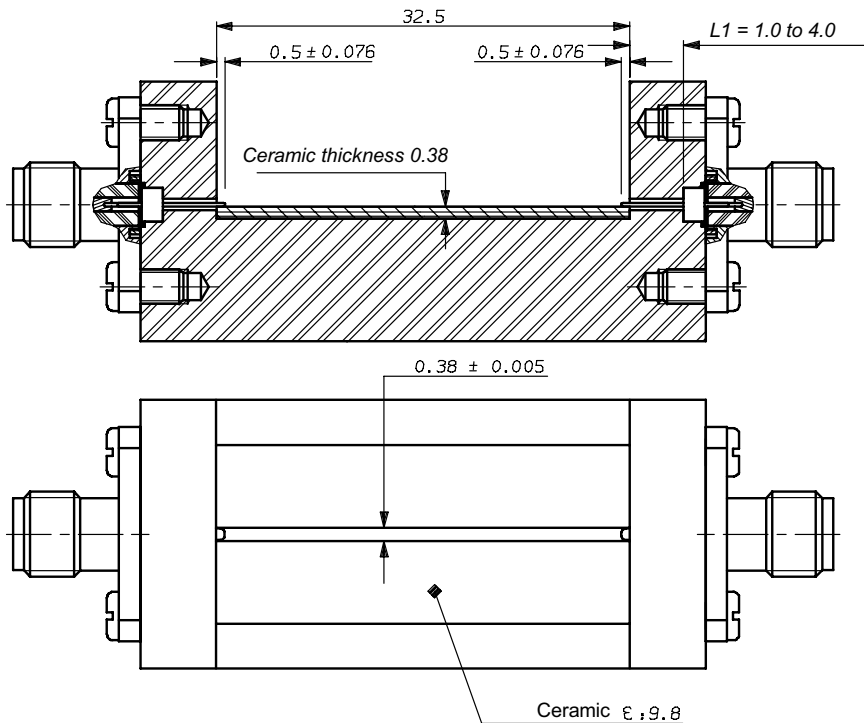

The track width on ceramic defines the circuit impedance.



## Field Replaceable Hermetic Microstrip Receptacle Information

## GLASS BEAD AND CONNECTOR ASSEMBLY INTO THE MICRO ELECTRONIC PACKAGE

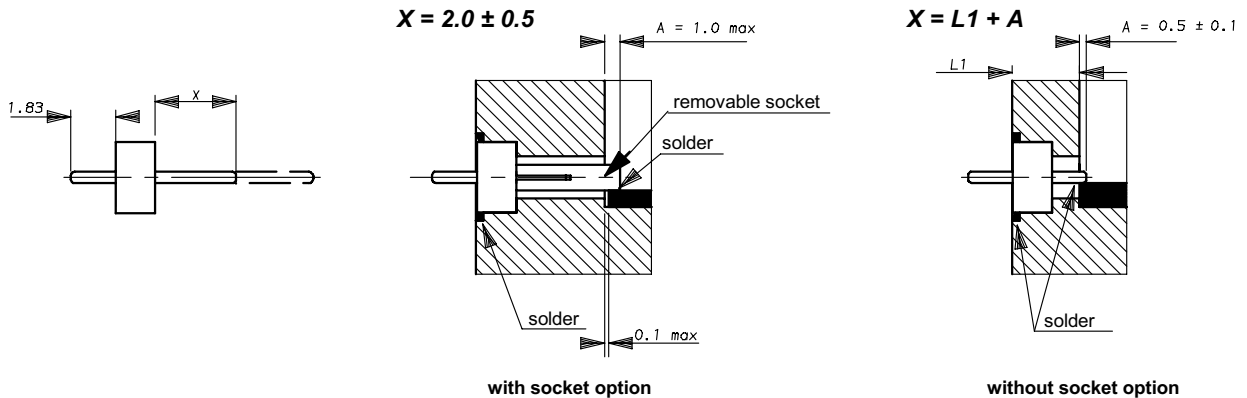
**GLASS BEAD**

1. Adjust X by cutting the pin if necessary
2. Introduce the glass bead into its cavity
3. Place a ring of solder in the groove around the glass bead (a 0.3 mm wire dia. of solder is recommended)
4. Solder the pin (or optional socket) on the PCB trace inside the package

Note: there is not too much welding.

**IMPORTANT:** For maximum RF performance, the link track/pin must be as thin as possible.

Therefore, we advise to follow the A dimension rigorously, by soldering accurately the pin or the socket directly on the trace.

**CONNECTOR RECEPTACLE**

Place the "EMI" screening gasket in the groove of the receptacle (if applicable).

Introduce gently the receptacle on the glass bead pin, then screw the flange (use the appropriated tool for screw-in receptacle).

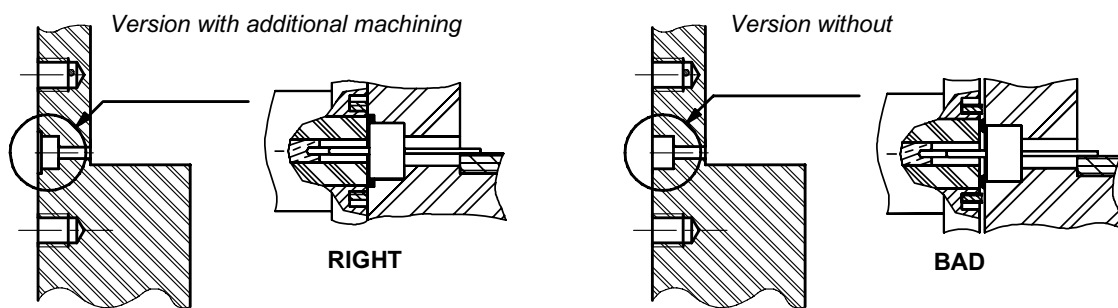
**GLASS BEAD MOUNTING**

The Radiall panel drilling on page 8-27 recommends an additional bore or chamfer machining on the outer edge of the glass bead housing. This additional machining allows to place a pre-form (solder stick Dia. 0.3 mm) before soldering.

After mounting, solder is flush and allows the right positioning of the receptacle.

The EMI gasket efficiency is guaranteed.

## Introduction

Radiall Commercial SMA connectors are specially designed for applications where low installation cost are most important. They are easy, fast to assemble and reliable, and offer the perfect solution for high volume applications requiring high level performance such as in civil telecommunications, data communications or test and measurement.

- **Full compatibility:**

Commercial SMA connectors are fully compatible (interchangeable and intermateable) with all existing MIL standardized SMA connectors. They feature the same performance level except for mechanical characteristics (life: 100 matings and coupling nut torque: 60 Ncm).

The coupling nut of Commercial SMA connectors features a special design which is different from the standard SMA coupling nut as the tightening torque is reduced.

- **Wide range:**

The Commercial SMA series offers a wide range of solutions which are for every standard coaxial flexible or semi-rigid cable as well as PCB models with traditional through-hole pins or solder pads for SMT applications.

- **Simple snap-in axial captivation (for full crimp models):**

The relative position of the center contact into the interface is mechanically guaranteed by the snapping of the insulator inner shoulder into the groove of the center contact.

This design facilitates the captivation operation in contrast to other designs, requiring two insulators to provide contact retention. It assures constant and perfect axial positioning of the center contact into the interface.

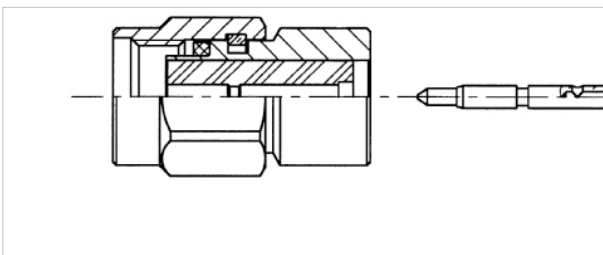

- **Space-saving size:**

Due to the captivation technique, these commercial SMA connectors are shorter than multi-piece body connectors.

- **Convenient 3-piece design:**

- For straight models: body + center contact + outer ferrule
- For right angle models: single piece body + back cap + outer ferrule

- **Fast and reliable cable attachment:**

The cable connectors can be either fully crimped or soldered/crimped, offering full flexibility for high volume industrial production with standard manual or pneumatic tooling: fast and reliable

- The center contact can be either crimped or soldered
- The outer contact is attached to the cable by crimping a ferrule

- **Competitive pricing:**

The design and materials used in the manufacturing of the Commercial SMA series allow us to offer connectors at competitive prices to suit a wide range of applications. The connector body is manufactured in brass and the surface plating is available in either gold or in BBR finish (Radiall non-magnetic bright bronze surface finish).

- **Center contact captivation:**

Our connectors have a captive center contact.

Introduction

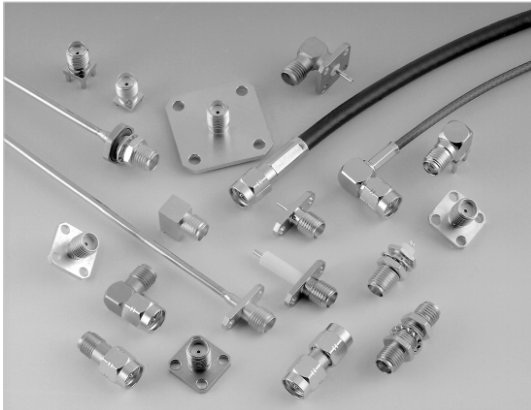

50Ω

DC - 18 GHz

**GENERAL**

- Subminiature coaxial connectors
- Screw-on coupling
- High RF performance
- 2 plating options:
  - BBR
  - Gold

**APPLICABLE STANDARDS**

- MIL-C-39012
- IEC 169-1
- CECC 22110
- CECC 22111 - 801 to 808
- BS 9210 N006

**APPLICATIONS**

- Telecommunications
- Aeronautics
- Measurement and Test systems
- General electronics

Interface

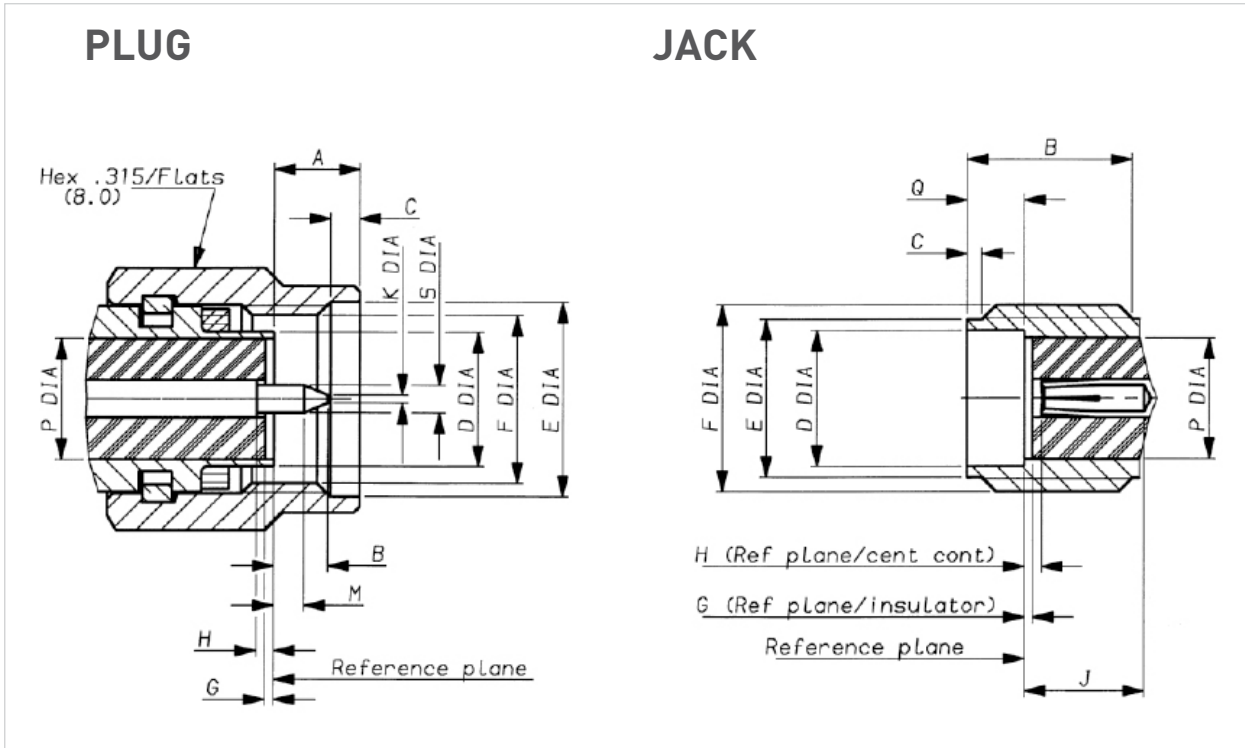

Letter	mm		inch	
	min.	max.	min.	max.
A	-	3.43	-	.135
B	-	2.54	-	.100
C	0.38	1.14	.015	.045
D DIA	-	4.59	-	-
E DIA	6.35	-	.250	-
F DIA	1/4 36 UNS 2B			
G*	0.0	-0.20	0.0	-.008
H*	0.0	-0.25	0.0	-.010
J	-	-	-	-
K DIA	-	0.38	-	.015
M	1.27	-	.050	-
P DIA	4.10 nom.		.161 nom.	
Q DIA	-	-	-	-
S DIA	0.90	0.94	.035	.037

Letter	mm		inch	
	min.	max.	min.	max.
A	-	-	-	-
B	4.31	-	.170	-
C	0.38	1.14	.015	.045
D DIA	4.596	-	.181	-
E DIA	5.28	5.49	.208	.216
F DIA	1/4 36 UNS 2A			
G*	0.0	-0.20	0.0	-.008
H*	0.0	-0.25	0.0	-.010
J	2.92	-	.115	-
K	-	-	-	-
M	-	-	-	-
P DIA	4.10 nom.		.161 nom.	
Q	1.88	1.98	.074	.078
S DIA	-	-	-	-

**NOTE:**  
Means behind ref plane

## Characteristics

Test / Characteristics	MIL-C-39012 paragraph	Values / Remarks
------------------------	-----------------------	------------------

## GENERAL

Impedance	-	50Ω
Frequency range	-	Semi-rigid cables
	-	Standard models
Temperature range	-	DC - 18 GHz
	-	DC - 12.4 GHz
	-	- 65°C + 105°C
	-	- 65°C + 165°C

## ELECTRICAL CHARACTERISTICS

Insulation resistance	3-11	5000 MΩ mini.			
Contact resistance	3-16	Initial		After test	
	• Outer conductor	3 mΩ	4 mΩ		
• Inner conductor	-	2 mΩ	3 mΩ		
V.S.W.R. max up to: 18 GHz for semi-rigid cable 12.4 GHz for right angle connector (SR) 12.4 GHz for flexible cable	3-14	.085"	.141"	2.6/50/S	5/50/D
		1.07 + .01F 1.10 + .01F	1.05 + .01F 1.10 + .01F	1.15 + .02F 1.15 + .03F	1.15 + .01F 1.15 + .02F
• Straight Connector					
• Right angle connector					
Dielectric withstanding voltage in VRMS	3-17	750	1000	750	1000
Working voltage in VRMS (sea level)	-	335	500	250	335
Working voltage in VRMS (70 000 ft)	-	85	125	65	85
RF testing voltage at 5 MHz in VRMS	3-23	500	670	500	670

## MECHANICAL CHARACTERISTICS

Cable retention force	3-24	.085"	.141"	2.6/50/S	5/50/D
		130 N	270 N	90 N	204 N
Life	3-15	100 matings			
Force to engage and disengage	3-5-1	23 Ncm - 2 inch pounds			
Coupling nut torque recommended	-	60 Ncm - 5.2 inch pounds			
Coupling nut retention force	3-25	272 N min			

## ENVIRONMENTAL CHARACTERISTICS

Vibration	3-18	MIL STD 202, method 204, condition D,20g
Shock	3-19	MIL STD 202, method 213, condition 1,100g
Thermal shock	3-20	MIL STD 202, method 107, condition B,
Corrosion (salt spray)	3-13	MIL STD 202, method 101, condition B,
Moisture resistance	3-21	MIL STD 202, method 106
Barometric pressure	3-22	MIL STD 202, method 105, condition C
Hermetic test	-	Down to 10 <sup>-6</sup> mmHg (Torr) leakage rate < 10 <sup>-8</sup> atm/cm <sup>3</sup> /sec
Life (at high temperature)	-	MIL STD 202, method 108

## MATERIALS AND PLATING

	Material	Plating
Bodies	Brass	BBR* or Gold plated
Center contacts	Beryllium copper (female) Brass (male)	Gold plated
Insulators	PTFE teflon	-
Gaskets	Silicone rubber	-

\*BBR: Bright Bronze Radiall

All dimensions are given in mm.

Standard packaging: 100 pieces

Plugs

**STRAIGHT PLUGS, FULL CRIMP TYPE FOR FLEXIBLE CABLE**

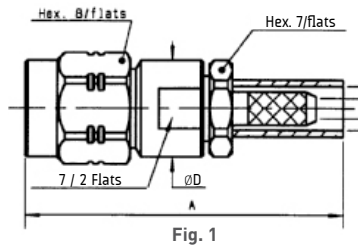

Fig. 1

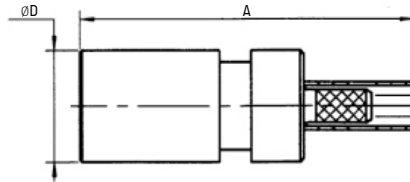

Fig. 2

Cable group	Cable group dia.	Part number (Gold)	Part number (BBR)	Fig.	Dimensions (mm)		Captive center contact	Note
					A	D		
RG178 / RG196	2/50/S	R124 069 123	R124 069 120	1	25	7.7	Yes	Back nut / Solder contact
RG174 / RG316	2.6/50/S	R124 071 123	R124 071 120	2	23.4			-
RD316	2.6/50/D	-	R124 072 220		26.4			-
RG58 / RG141	5/50/S	R124 075 323	R124 075 320	1	26.3			-
RG142 / RG223 / RG400	5/50/D	R124 076 323	R124 076 320		27.15			7
AEP-195FR	LMR® 195	-	R124 075 210		29.15	7	-	
AEP-200FR	LMR® 200	-	R124 076 450	1	33.59	12.7	Crimp type	
AEP-240FR	LMR® 240	-	R124 076 430		1	33.59	12.7	Crimp type
AEP-400FR	LMR® 400	-	R124 080 030					

**STRAIGHT PLUGS, SOLDER TYPE FOR SEMI-RIGID CABLE**

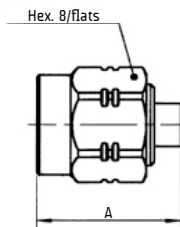

Fig. 1

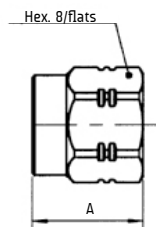

Fig. 2

Cable group	Cable group dia.	Part number (Gold)	Fig.	Dimensions A (mm)	Captive center contact
RG405	.085"	R124 052 013	1	11.1	No
RG402	.141"	R124 054 003	2	8.5	Yes
		R124 055 003	1	11.2	No

## Plugs and Jacks

### RIGHT ANGLE PLUGS

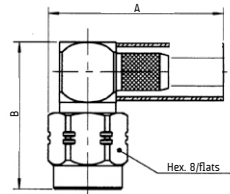

Fig. 1

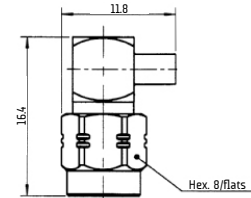

Fig. 2

Cable group	Cable group dia.	Part number (Gold)	Part number (BBR)	Fig.	Dimensions (mm)		Note
					A	B	
RG174 / RG316 / AEP-100FR	2.6/50/S & LMR® 100	R124 172 123	R124 172 120	1	18	16.35	Crimp type for flexible cable
RD316	2.6/50/D	R124 174 123	R124 174 120				
RG58 / RG141	5/50/S	R124 175 123	R124 175 120				
RG142 / RG223 / RG400	5/50/D	R124 176 123	R124 176 120				
AEP-195FR	LMR® 195	-	R124 175 110	2	16.29	19.67	Crimp type
AEP-200FR	LMR® 200	-	R124 175 200		-	16.3	
AEP-240FR	LMR® 240	-	R124 175 310		-	-	
RG405	.085"	R124 153 003	R124 153 001		-	-	
RG402	.141"	R124 154 001	R124 154 001	-	-		

### STRAIGHT JACKS

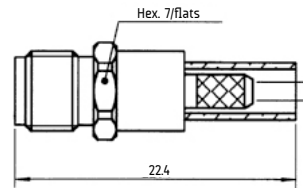

Fig. 1

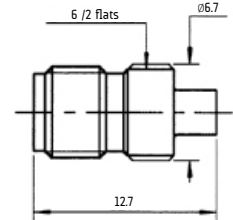

Fig. 2

Cable group	Cable group dia.	Part number (Gold)	Fig.	Captive center contact	Note
RD316	2.6/50/D	R124 233 123	1	Yes	Full crimp type for flexible cable
RG174 / RG316	2.6/50/S	R124 236 123			
RG405	.085"	R124 222 003	2	No	Solder type for semi-rigid cable

Jacks

**BULKHEAD FEEDTHROUGH STRAIGHT JACKS, FULL CRIMP TYPE, FOR FLEXIBLE CABLE**

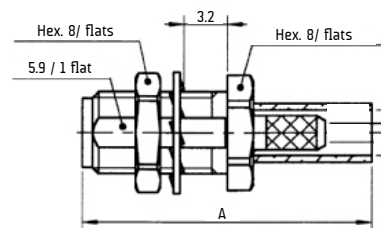
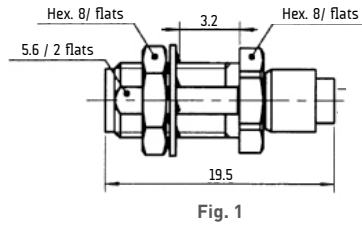
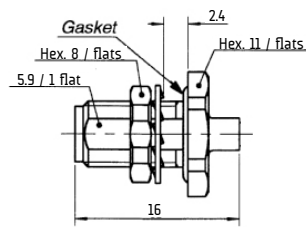

Fig. 2

Cable group	Cable group dia.	Part number (Gold)	Part number (BBR)	Fig.	Dimensions A (mm)	Panel drilling	Captive center contact	Note
RG178 / RG196	2/50/S	R124 310 023	-	1	-	P06		Reverse crimping / Solder contact
RG174 / RG316 / AEP-100FR	2.6/50/S & LMR® 100	R124 312 123	R124 312 120	2	22.4	P05	Yes	-
RG 58 / RG141	5/50S	-	R124 314 120		25.4			Full crimp type
RG142 / RG223 / RG400	5/50/D	-	R124 315 120					

**BULKHEAD FEEDTHROUGH STRAIGHT JACKS, SOLDER TYPE, FOR SEMI-RIGID CABLE - PANEL SEAL**



Cable group	Cable group dia.	Part number (Gold)	Panel drilling	Captive center contact
RG405	.085"	R124 326 003	P05	No
RG402	.141"	R124 325 003		

**FLANGE JACKS, SOLDER TYPE FOR SEMI-RIGID CABLE**

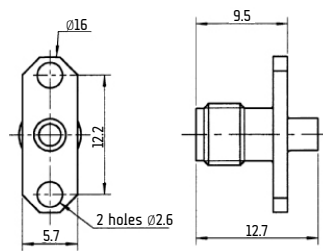

Fig. 1

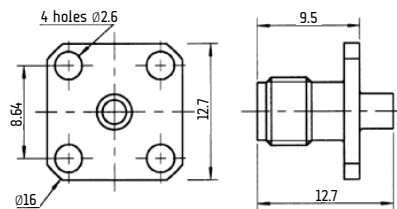

Fig. 2

Cable group	Cable group dia.	Part number (Gold)	Fig.	Panel drilling	Captive center contact
RG405	.085"	R124 252 003	1	P04	No
		R124 256 003	2	P02	
RG402	.141"	R124 255 003			



Receptacles

SQUARE FLANGE FEMALE RECEPTACLES

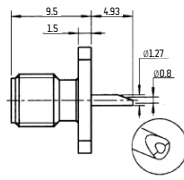
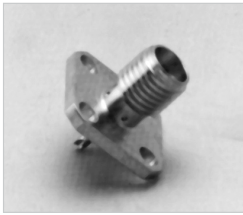

Fig. 1

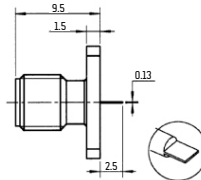

Fig. 2

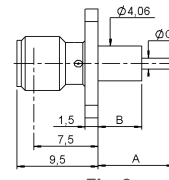

Fig. 3

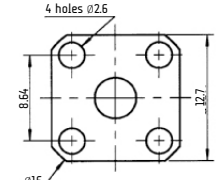

Fig. 1 to 3

Part number	Fig.	Dimensions (mm)			Panel drilling	Finish	Captive center contact
		A	B	C			
R124 403 123	1	-	-	-	P01	Gold	Yes (4 indents)
R124 413 025	3	8.9	5.1	1.28			
R124 415 273		17.9	15	1.27			
R124 510 000	2	-	-	-	BBR		

NARROW FLANGE FEMALE RECEPTACLES

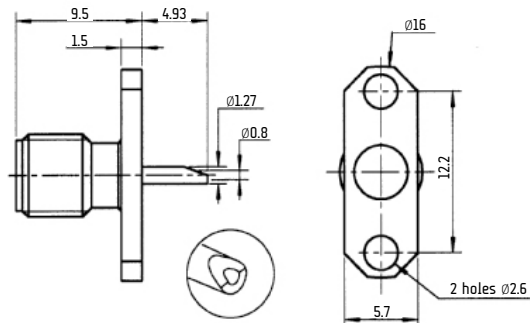

Fig. 1

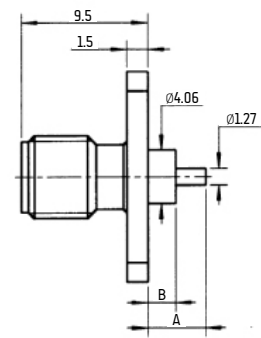
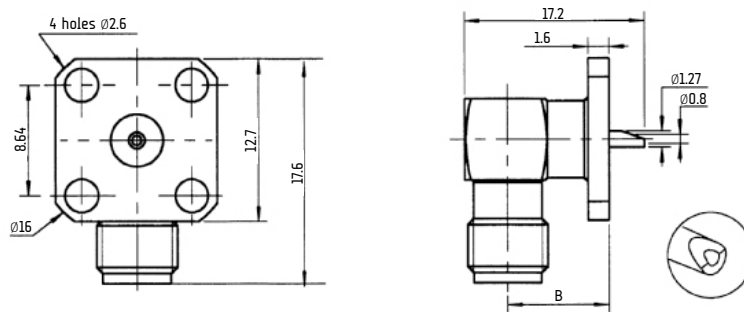

Fig. 2

Part number	Fig.	Dimensions (mm)		Panel drilling	Finish	Captive center contact
		A	B			
R124 454 123	1	-	-	P04	Gold	Yes (4 indents)
R124 464 000	2	15.9	12.7		BBR	

RIGHT ANGLE SQUARE FLANGE FEMALE RECEPTACLES



Part number	Panel drilling	Finish
R124 654 003	P02	Gold

Switches

STRAIGHT FEMALE PCB RECEPTACLES AND SWITCHES

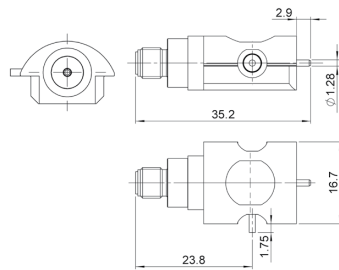

Fig. 1

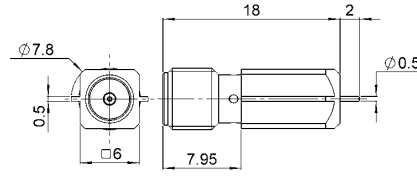

Fig. 2

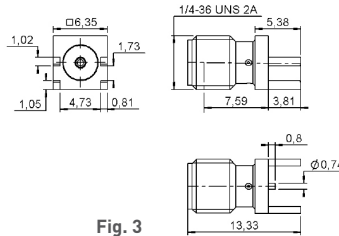
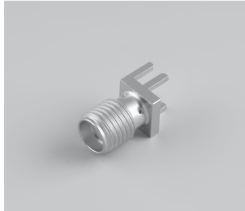

Fig. 3

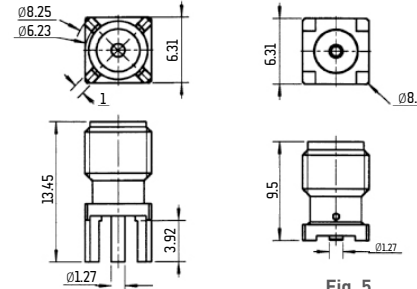

Fig. 4

Fig. 5

Part number	Fig.	Panel drilling	Assembly instructions	Finish	Note
R124 422 001	1	-	M03	Gold	Switch edge card SMT - Right type - Packaging in Reel 110 pieces
R124 423 033	2	-	M02		SMT edge card type - Packaging: unit
R124 423 223	3	-	-	-	-
R124 426 120	4	P03	-	BBR	-
R124 426 123			-	-	-
R124 427 000	5	-	M01	Gold	Surface mount / Bulkhead 100 pieces
R124 427 800		-			Surface mount / Tape & Reel 100 pieces

RIGHT ANGLE FEMALE PCB RECEPTACLES

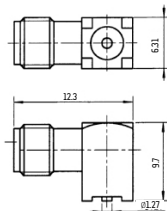
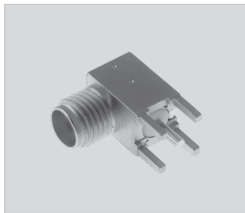

Fig. 1

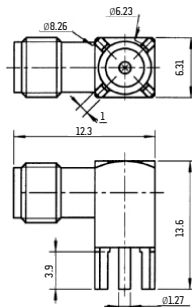

Fig. 2

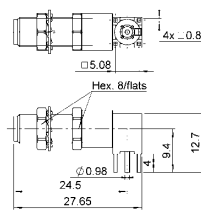

Fig. 3

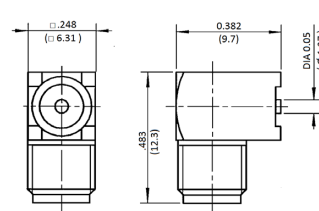
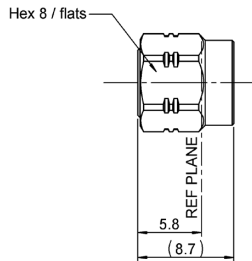

Fig. 4

Part number	Fig.	Panel drilling	Assembly instructions	Finish	Note
R124 667 143	3	P07	-	Gold	Packaging: tray 60 pieces
R124 680 120	2	P03	-	BBR	-
R124 680 123				-	-
R124 681 000	1	-	M01	Gold	Surface mount / Bulkhead 100 pieces
R124 681 800	4	-	M04		Packaging: Tape & Reel 100 pieces

## Receptacles

### MALE CAP



Part number	Finish	Note
R124 802 108	Tin	No chain

### ADAPTERS

For in series adapters, please see standard SMA.

### Panel Drilling

#### P01

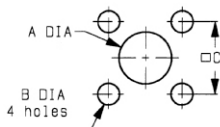

	MM		INCH	
	maxi	mini	maxi	mini
A	4.2	4.1	0.165	0.161
B	2.7	2.6	0.106	0.102
C	8.69	8.59	0.342	0.338

#### P02

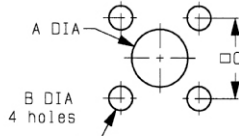

	MM		INCH	
	maxi	mini	maxi	mini
A	6.6	6.5	0.26	0.256
B	2.7	2.6	0.106	0.102
C	8.69	8.59	0.342	0.338

#### P03

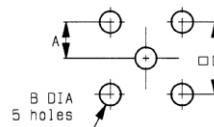

	MM		INCH	
	maxi	mini	maxi	mini
A	2.59	2.49	0.102	0.098
B	1.7	1.6	0.067	0.063
C	5.13	5.03	0.202	0.198

#### P04

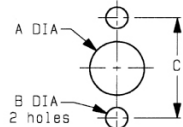

	MM		INCH	
	maxi	mini	maxi	mini
A	4.2	4.1	0.165	0.161
B	2.7	2.6	0.106	0.102
C	12.25	12.15	0.482	0.478

#### P05

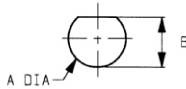

	MM		INCH	
	maxi	mini	maxi	mini
A	6.5	6.4	0.256	0.252
B	6.15	6	0.242	0.238

#### P06

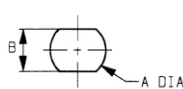

	MM		INCH	
	maxi	mini	maxi	mini
A	6.5	6.4	0.256	0.252
B	5.8	5.7	0.228	0.224

#### P07

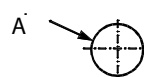

	mm	
	Maxi	mini
A	6.40	6.35

Assembly Instructions

M01

Part number	
R124 427 000 R124 427 800	R124 681 000

SOLDERING PATTERN

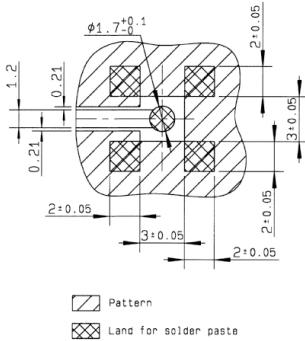

COPLANAR LINE

- Pattern and signal are on the same side
- Thickness of PCB: 1.6 mm
- The PCB material is made of epoxy resin of glass fabrics bacs (Er = 4.8)
- The solder resist should be printed except for the land pattern on the PCB

ASPIRATION PORT

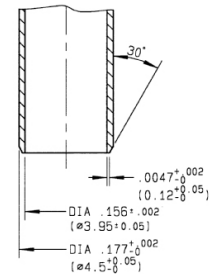

VIDEO SHADOWS

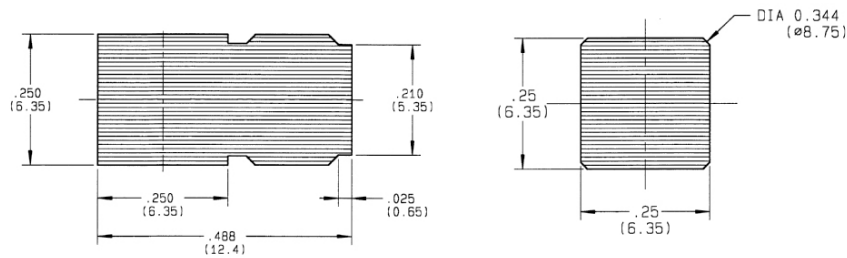

M02

SOLDERING PATTERN

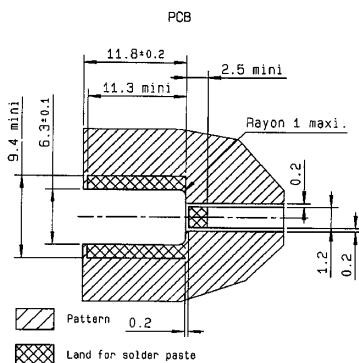

Part number
R124 423 033

COPLANAR LINE

- Pattern and signal are on the same side
- Thickness of PCB: .063 (1.6 mm)
- The PCB material is made of epoxy resin of glass fabrics bacs. (Er = 4.8)
- The solder resist should be printed except for the land pattern on the PCB

ASPIRATION PORT

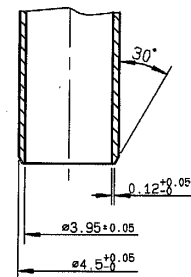

VIDEO SHADOW

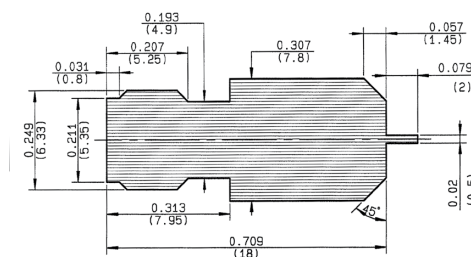

## Assembly Instructions

### M03

#### PCB FOR SMA SWITCH

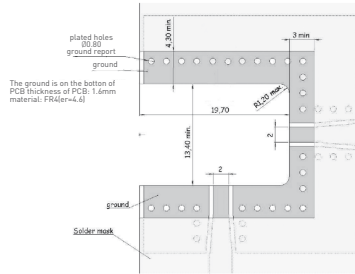

Part number
R124 422 001

#### VIDEO SHADOW

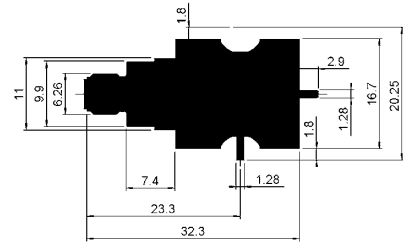

### M04

#### SOLDERING PATTERN

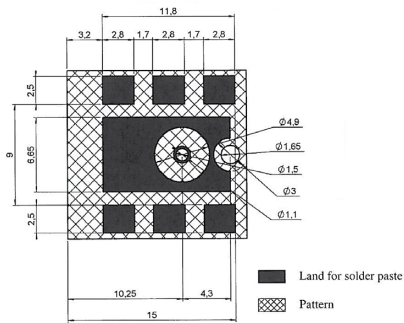

Part number
R124 681 800

#### VIDEO SHADOW

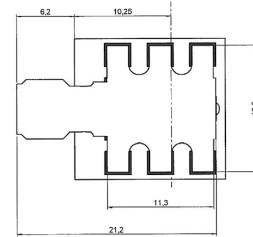

#### COPLANAR LINE

- Pattern and signal are on the same side
- Thickness of PCB: .063 (1.6 mm)
- The PCB material is made of epoxy resin of glass fabrics bacs. (Er = 4.8)
- The solder resist should be printed except for the land pattern on the PCB

# Mouser Electronics

Authorized Distributor

Click to View Pricing, Inventory, Delivery & Lifecycle Information:

[Radial:](#)

[R128425320](#) [R128639121W](#) [R128444211](#) [R128005321W](#) [R128084030W](#)