

**DIGITAL CATALOG**

# Microminiature Coaxial Connectors

**SSMB  
SSLB  
SSMC**

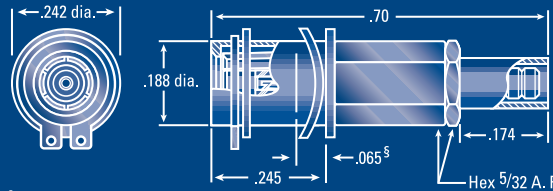
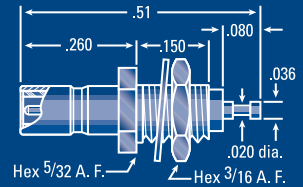

§ From internal mating plane (end of mating connector when fully engaged) to rear of panel

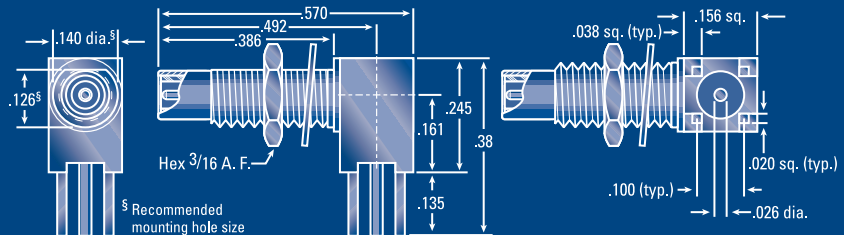
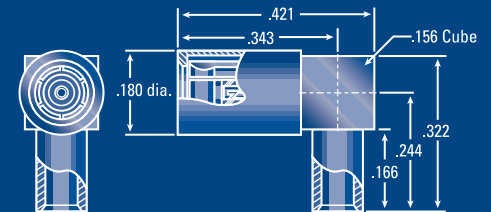
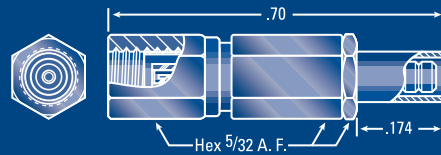
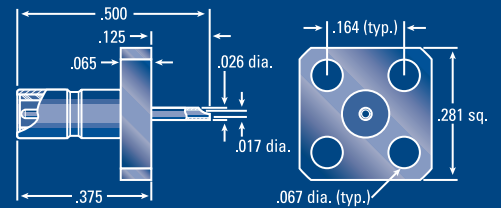
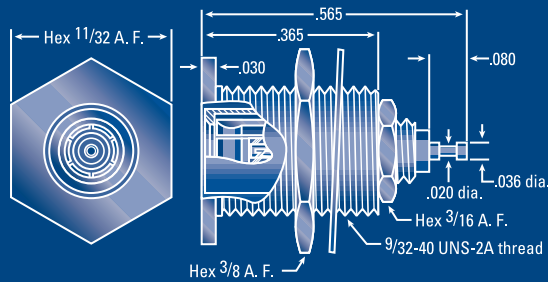

§ Recommended mounting hole size



**APPLIED ENGINEERING PRODUCTS**

104 John W. Murphy Drive • P.O. Box 510 • New Haven, CT 06513

(203) 776-2813 • FAX (203) 776-8294

www.aep.us • e-mail: aepsales@aep.us



# SSMB/SSLB/SSMC Microminiature Connectors

Click at the bottom of any page to go to the AEP website.

## Contents

(Click on any line to jump to the page)

<b>Introduction</b> . . . . .	<b>2</b>
<b>Technical Information</b>	
Special features and options . . . . .	<b>3</b>
Mated-pair dimensions . . . . .	<b>4</b>
Interfaces and specifications . . . . .	<b>5</b>
VSWR data . . . . .	<b>6</b>
<b>SSMB Series</b>	
Cable connectors . . . . .	<b>7</b>
Bulkhead mounted receptacles . . . . .	<b>9</b>
P.C. board receptacles . . . . .	<b>10</b>
Panel mounted receptacles . . . . .	<b>14</b>
Adapters . . . . .	<b>14</b>
<b>SSLB Series</b>	
Cable connectors . . . . .	<b>15</b>
Vibration-proof float mount plugs . . . . .	<b>16</b>
Bulkhead mounted receptacles . . . . .	<b>17</b>
P.C. board receptacles . . . . .	<b>18</b>
<b>SSMC Series</b>	
Cable connectors . . . . .	<b>20</b>
Bulkhead mounted receptacles . . . . .	<b>22</b>
P.C. board receptacles . . . . .	<b>23</b>
Panel mounted receptacles . . . . .	<b>27</b>
Adapters . . . . .	<b>27</b>
<b>P.C. Board Mounted Cable Terminations</b> . . . . .	<b>28</b>
<b>Assembly Tooling</b> . . . . .	<b>29</b>
<b>Index by AEP Part Number</b> . . . . .	<b>30</b>
<b>About AEP</b> . . . . .	<b>31</b>



# SSMB/SSLB/SSMC Microminiature Connectors

## Introduction

**SSMB** (snap-on mating), **SSLB** (slide-on mating), and **SSMC** (screw-on mating) microminiature connectors from AEP can be the answer you're looking for in your applications that are short on space but need to be long on performance.

Although SSMB and SSMC connectors are about a third smaller than SMB and SMC connectors, AEP's design skills and materials engineering make them remarkably rugged—in most cases, even more reliable than their larger counterparts. For example, AEP's SSMB connectors have been tested to over

1,000 mating cycles (twice the MIL-spec requirement) without loss of performance. And because they are included in MIL-PRF-39012, you don't have to take the risk of using a proprietary design—AEP's SSMB and SSMC connectors are fully intermateable with other manufacturers' parts.

The superior electrical characteristics of SSMB and SSMC connectors (see page 6) even makes them an alternative to much larger SMA connectors in many applications.

In this catalog, you'll find such innovative and useful configurations as:

- P.C. board receptacles with pretinned legs and contacts (see page 3 for more information);
- Surface-mountable P.C. board receptacles, in top and edge mount types (see page 3 for more information);
- P.C. board cable terminations, for easy, permanent attachment of cable to P.C. boards without the need to pigtail cable braid (see page 28);
- Vibration-proof, float mounted SSLB plugs, ideal for use in rack-and-panel applications with multiple connector pairs (see page 4 for more information)

All SSMB, SSLB, and SSMC connectors are gold-plated for superior electrical and environmental performance.

**Save yourself time, money, and trouble**—call the experts at AEP for complete cable assemblies using SSMB, SSLB, and SSMC connectors. With experience in producing thousands of microminiature cable assemblies for such demanding applications as SINCGARS (the U.S. Army's primary tactical field radio system), AEP can provide you with complete, tested, guaranteed cable assemblies—flexible or semi-rigid; any size, any quantity.

## HOW THEY STACK UP:

(mated pairs)

### Right angle PCB receptacle and straight cable plug

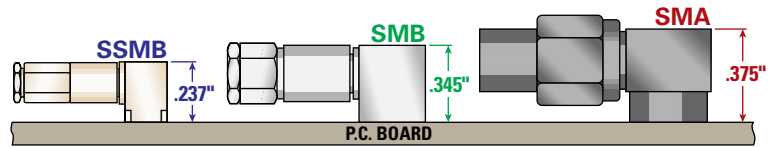

### Straight PCB receptacle and right angle cable plug

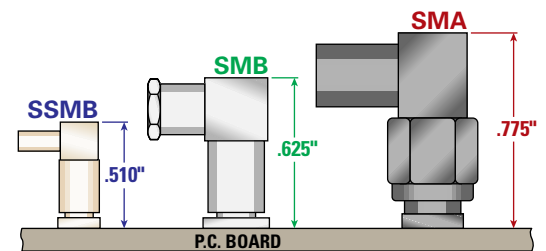

(SSMC series offers similar space savings vs. SMC and SMA)



# SSMB/SSLB/SSMC Features and Options

## Surface Mount P.C. Board Receptacles

AEP SSMB and SSMC surface-mount P.C. board receptacles are available in top mount and edge mount types (see below). when mounted, they withstand torque, shear, and pull forces greatly in excess of standard mating and unmating forces. Tape-and-reel packaging is available for top-mount versions.

AEP surface-mount P.C. board receptacles meet all interface requirements of MIL-STD-348, and appropriate performance requirements of MIL-PRF-39012. Most configurations can also be furnished with pretinned legs (see bottom of this page) for convenient, reliable assembly.

Edge-mount types in this catalog are designed for .031" thick P.C. boards, but they are readily available for boards up to .045" thick. Connectors for thicker boards can be supplied by special order.

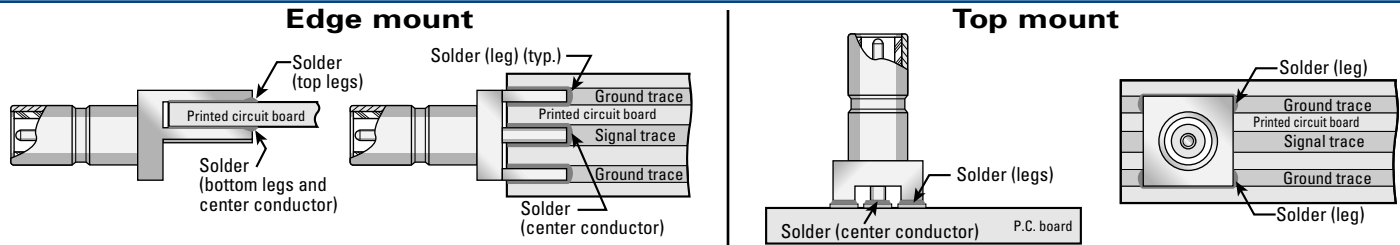

Combining AEP's surface-mount technology with various body styles and interfaces can provide an almost unlimited variety of configurations—these are just a few examples.

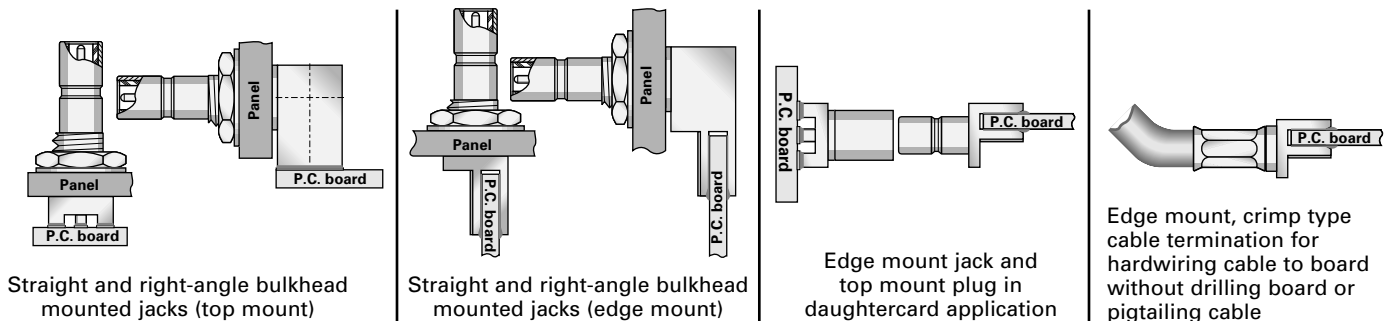

## P.C. Board Receptacles with Pretinned Legs and Contacts

AEP pretinned P.C. board receptacles are shipped with a tightly-controlled layer of solder on the legs and center conductor, eliminating gold embrittlement in solder joints. Nickel-plated connectors with pretinned legs have the solderability of gold or silver-plated connectors at lower cost.

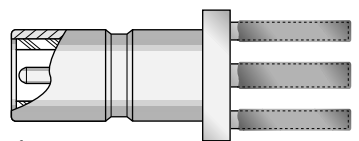

Hot solder dip (legs and contact) Sn63, .002-.005 thick, to within .040 of body, 95% minimum coverage, gold removed during tinning operation.



Computer-controlled, automated solder-dipping equipment and custom fixturing ensure precise, consistent coverage to AEP standard specification (see above), or customer-specified requirements.

Tinned areas meet the solderability requirements of MIL-STD-202, Method 208 after eight hours steam aging. Pretinned legs are available on most P.C. board receptacles in this catalog—see product pages for part numbers.

## P.C. Board Receptacles with Standoff Legs

AEP P.C. board receptacles with stepped legs raise the connector body above the board surface, allowing free flow of cleaning solutions and air, as well as providing space for visual inspection.

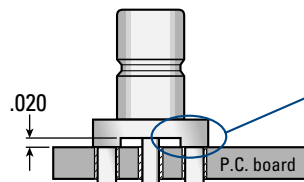

Standoffs milled into legs hold the connector body a precise distance above the board during soldering.



# SSMB/SSLB/SSMC Features and Options

## Vibration-Proof Float Mounted Plugs (see page 14)

AEP's vibration-proof float mounted plugs (SSLB series only) use a tempered spring washer within the mounting system for reliable grounding between the connector and the panel under vibration. Mounting integrity is augmented by the Truarc retaining ring, which provides almost 360° of contact within its retaining groove, as opposed to the 10–20° of contact typical of C-ring or E-ring retaining clips. This makes it virtually impossible to dislodge the connectors from their panel mountings under any conditions of mechanical stress.

This system, combined with closed-end mating hoods and inner female contacts, allows the connectors a wide range of float while mating without damage to the connectors. Their reliability has been proven through thousands of hours of flight time in avionics systems over the past ten years without a single field failure.

Misaligned mating connectors press against the tapered hood during mating...

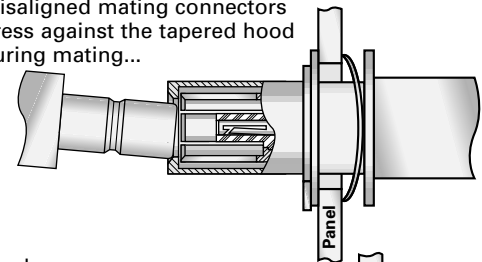

...and the hood guides the float-mounted connector into alignment for proper mating, while the spring washer deflects to accommodate the angular and radial movement with no loss of grounding.

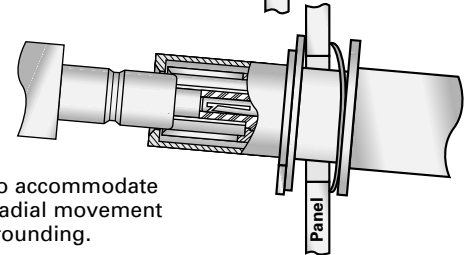

## Mated-Pair Dimension Examples

The examples below illustrate working dimensions for some common connector pair applications (SSMB and SSLB series connectors). Multiple pairs can be placed on spacing as close as .200" centerlines. Mated pairs of SSMC connectors have similar envelope dimensions, but additional space should be allowed on all axes for wrench access when mating.

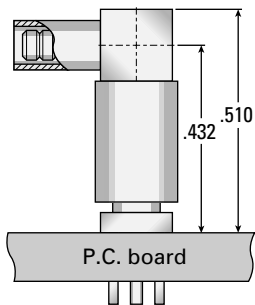

Right angle cable plug (7405 series) and straight P.C. board jack receptacle (7209 series)

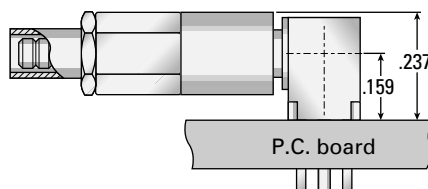

Straight cable plug (7202 series) and right angle P.C. board jack receptacle (7210 series)

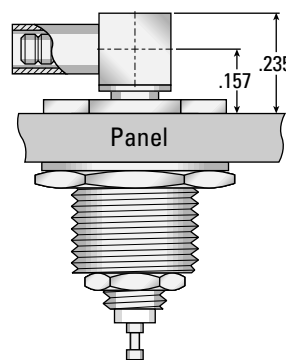

Right angle cable jack (7441 series) and recessed bulkhead jack receptacle (7496 series)

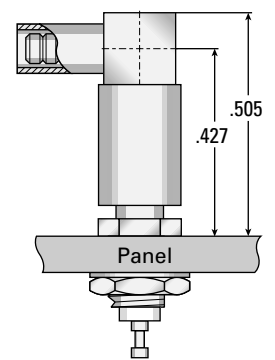

Right angle cable plug (7405 series) and straight bulkhead jack receptacle (7219 series)

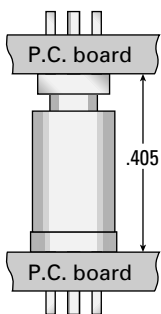

Straight P.C. board plug (7225 series) and straight P.C. board jack (7209 series)

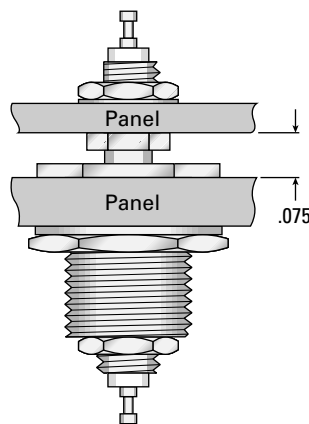

Straight bulkhead jack receptacle (7219 series) and recessed bulkhead jack receptacle (7496 series)

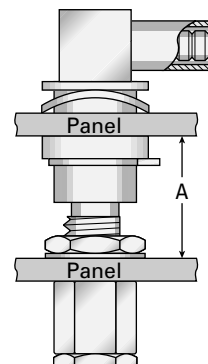

Right angle float-mounted cable plug (7335 series) and straight bulkhead cable jack (7303 series):

Panel Thickness	'A'
.050"	.360
.093"	.274

# SSMB/SSLB/SSMC Specifications

## SSMB Interface Dimensions

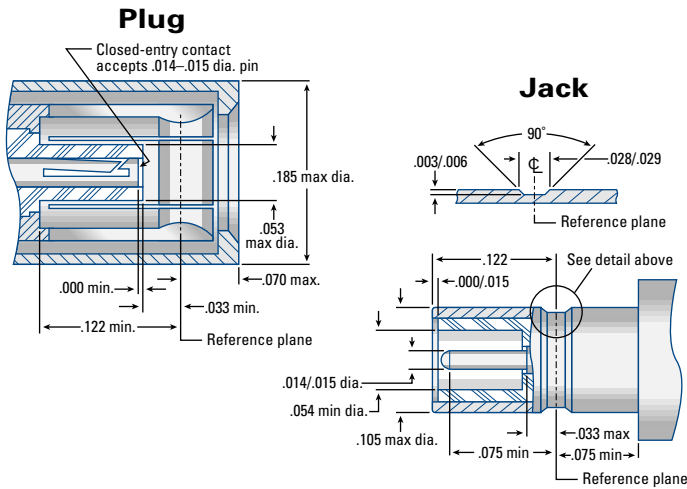

## SSLB Interface Dimensions

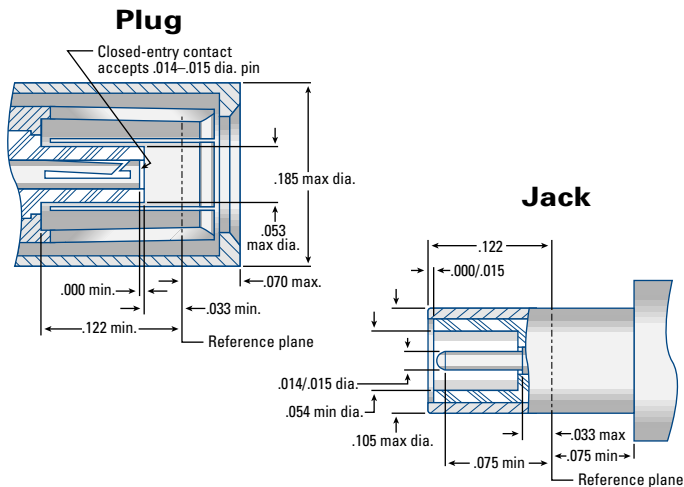

## SSMC Interface Dimensions

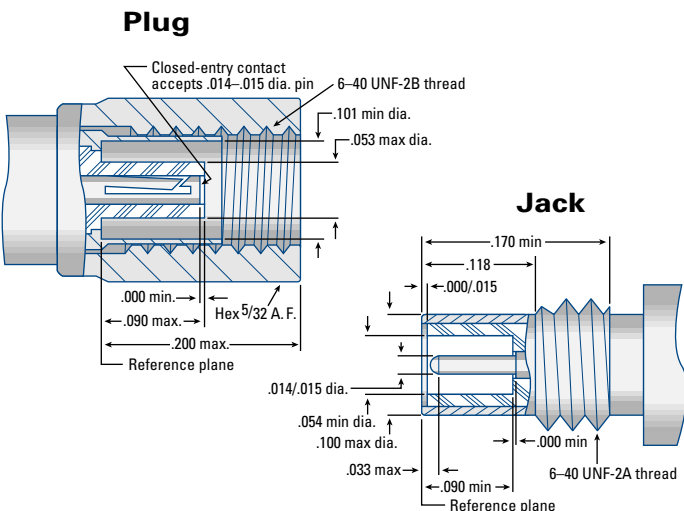

## Specifications

### SSMB and SSLB (MIL-PRF-39012 as applicable)

#### Materials:

**Plug spring fingers, center contacts:** Beryllium copper per ASTM-B-196, Condition HT.  
**Crimp sleeves:** Seamless copper tube per ASTM-B-75, type C12000, temper: light anneal 050.  
**Other metal parts:** Brass per ASTM-B-16, Alloy 360, 1/2 hard.  
**Insulators:** Teflon (TFE) per ASTM-D-1710.

#### Finish:

**Center contacts:** Gold plated per current revision of MIL-PRF-39012\*  
**Other metal parts:** Gold plated to meet current MIL-PRF-39012 corrosion requirements.\*

#### Electrical:

**Impedance:** 50Ω. **Frequency range:** DC-12.4 GHz.  
**Voltage Rating:** 250VRMS @ sea level; 60 VRMS @ 70,000 ft.  
**Insulation Resistance:** 1,000 megohms minimum.

#### Contact Resistance:

**Center contact:** Initial: 4.0 milliohms maximum;  
after environmental test conditions: 6.0 milliohms maximum.  
**Outer contact:** Initial: 1.0 milliohms maximum;  
after environmental test conditions: 1.5 milliohms maximum.

**Cable braid to body:** Initial: 1.0 milliohms maximum; after environmental test conditions: N/A.

**Corona level:** 125V @70,000 ft. **RF highpot:** 400 VRMS @ 5 MHz.

**RF leakage:** -70 dB min @ 2-3 GHz. **Insertion loss:** .30 dB max @ 1.5 GHz.

VSWR:	Cable	Straight connector	Right angle connector
RG-178		1.25 + (.020 x F[GHz])	1.25 + (.030 x F[GHz])
RG-316		1.30 + (.020 x F[GHz])	1.30 + (.030 x F[GHz])
	.085" semi-rigid	1.25 + (.015 x F[GHz])	1.25 + (.025 x F[GHz])

#### Mechanical:

**Force to engage:** *SSMB:* Initial, 6 pounds max engagement, 2 pounds min disengagement.  
After 500 matings, 6 pounds max engagement, 1 pound min disengagement.  
*SSLB:* Initial, 3 pounds max engagement, .5 pounds min disengagement.

**Contact retention:** 2 pounds min axial force.

**Durability:** 500 mating cycles.

#### Environmental (MIL-STD-202):

**Temperature range:** -65° C to +165° C. **Corrosion:** Method 101, condition B, 5% salt solution.

**Vibration (Method 204):** *SSMB:* Condition B (15G), *SSLB:* Condition A (10G).

**Mechanical shock (Method 213):** *SSMB:* Condition B, 75G @ 6 ms @ 1/2 sine, *SSLB:* N/A.

### SSMC (MIL-PRF-39012 as applicable)

#### Materials:

**Jack mating ends, center contacts:** Beryllium copper per ASTM-B-196, Condition HT.  
**Crimp sleeves:** Seamless copper tube per ASTM-B-75, type C12000, temper: light anneal 050.  
**Other metal parts:** Brass per ASTM-B-16, Alloy 360, 1/2 hard.  
**Insulators:** Teflon (TFE) per ASTM-D-1710.

#### Finish:

**Center contacts:** Gold plated per current revision of MIL-PRF-39012\*  
**Other metal parts:** Gold plated to meet current MIL-PRF-39012 corrosion requirements.\*

#### Electrical:

**Impedance:** 50Ω. **Frequency range:** DC-12.4 GHz.  
**Voltage Rating:** 250VRMS @ sea level; 60 VRMS @ 70,000 ft.  
**Insulation Resistance:** 1,000 megohms minimum.

#### Contact Resistance:

**Center contact:** Initial: 4.0 milliohms maximum;  
after environmental test conditions: 6.0 milliohms maximum.  
**Outer contact:** Initial: 1.0 milliohms maximum;  
after environmental test conditions: 1.5 milliohms maximum.

**Cable braid to body:** Initial: 1.0 milliohms maximum; after environmental test conditions: N/A.

**Corona level:** 125V @70,000 ft. **RF highpot:** 400 VRMS @ 5 MHz.

**RF leakage:** -50 dB min @ 2-3 GHz. **Insertion loss:** .30 dB max @ 1.5 GHz.

VSWR:	Cable	Straight connector	Right angle connector
RG-178		1.20 + (.020 x F[GHz])	1.20 + (.030 x F[GHz])
RG-316		1.25 + (.020 x F[GHz])	1.25 + (.030 x F[GHz])
	.085" semi-rigid	1.20 + (.015 x F[GHz])	1.20 + (.025 x F[GHz])

#### Mechanical:

**Force to engage:** 16 inch-ounces torque max.

**Mating torque:** 28-32 inch-ounces.

**Coupling nut pulloff resistance:** 25 pounds min.

**Contact retention:** 2 pounds min axial force.

**Durability:** 500 mating cycles.

#### Environmental (MIL-STD-202):

**Temperature range:** -65° C to +165° C. **Corrosion:** Method 101, condition B, 5% salt solution.

**Vibration (Method 204):** Condition D (20G).

**Mechanical shock (Method 213):** Condition B, 75G @ 6 ms @ 1/2 sine.

\*These specifications change periodically with updates to MIL-PRF-39012 requirements.  
Contact factory for latest specifications.



APPLIED ENGINEERING PRODUCTS

(203) 776-2813 • FAX (203) 776-8294 www.aep.us • aepsales@aep.us

# SSMB/SSLB/SSMC Specifications

## VSWR Data

----- Specification requirement

————— Actual (Connectors tested using 200' of cable as load.)

### SSMB

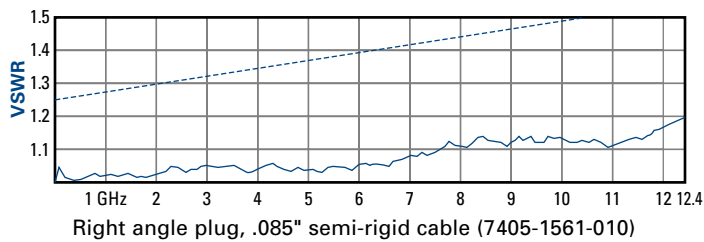
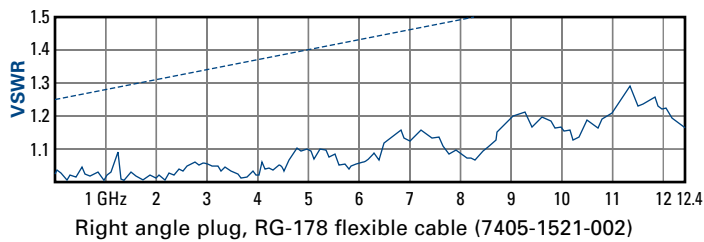
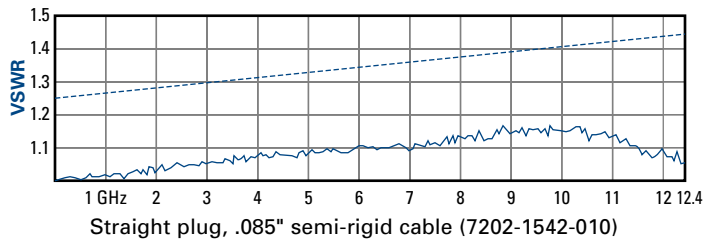
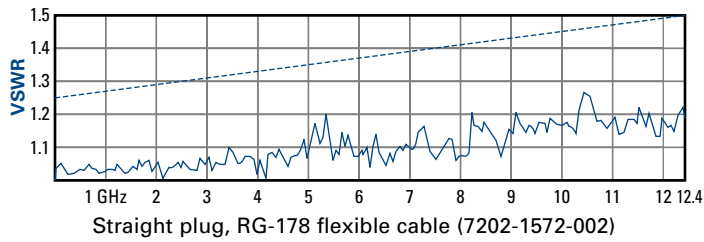

### SSMC

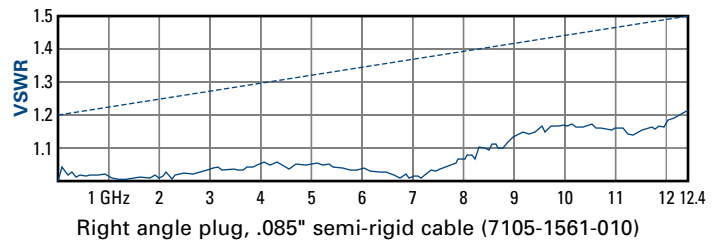
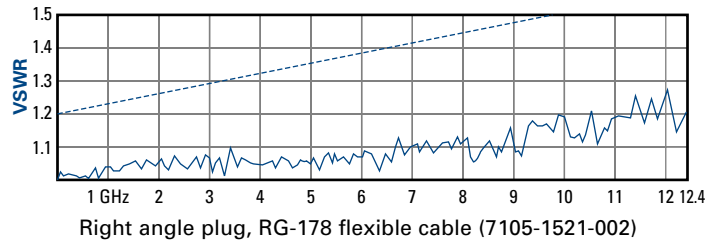
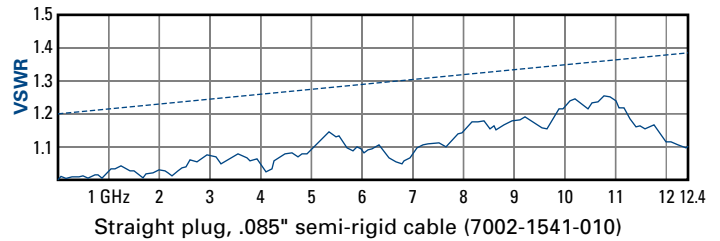
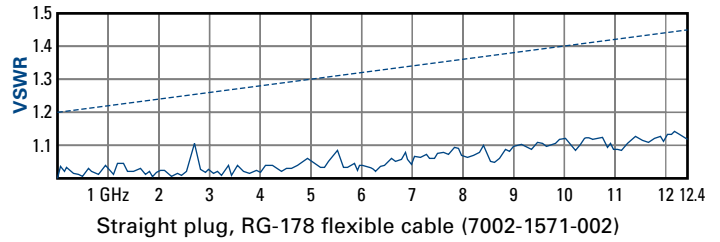

## Comparative VSWR

VSWR limits for SMA, SMB, SMC, MCX, and MMCX from MIL-PRF-39012 and/or manufacturer specifications

### SSMB

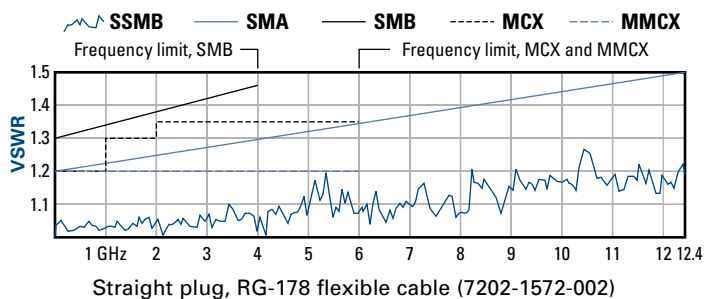

### SSMC

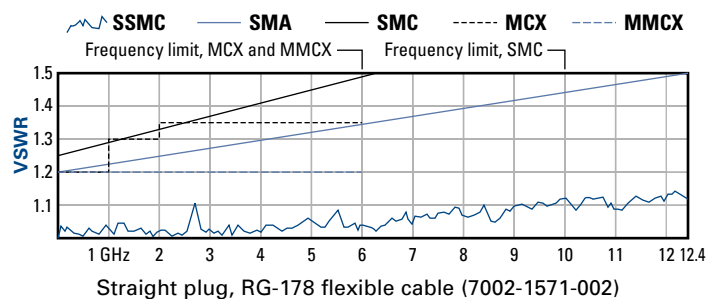

APPLIED ENGINEERING PRODUCTS

(203) 776-2813 • FAX (203) 776-8294 [www.aep.us](http://www.aep.us) • [aepsales@aep.us](mailto:aepsales@aep.us)

# SSMB Cable Connectors

## Straight Cable Plugs

**Crimp type for flexible cable**

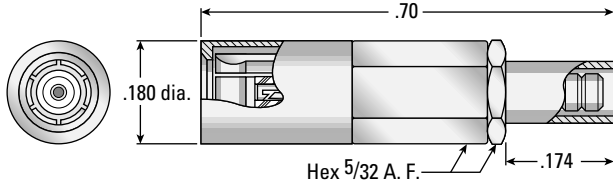

**AEP P/N**  
**7202-1572-0XX\***

**Solder type for semi-rigid cable**

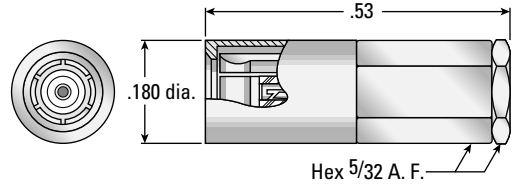

**AEP P/N**  
**7202-1542-0XX\***

## Right Angle Cable Plugs

**Crimp type for flexible cable**

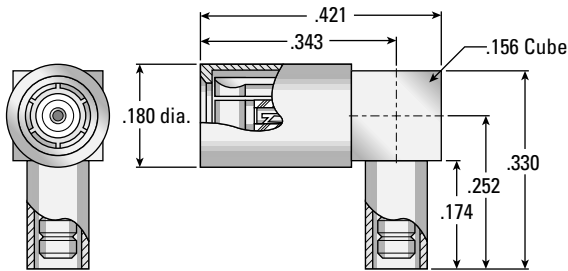

**AEP P/N**  
**7405-1521-0XX\***

**Solder type for semi-rigid cable**

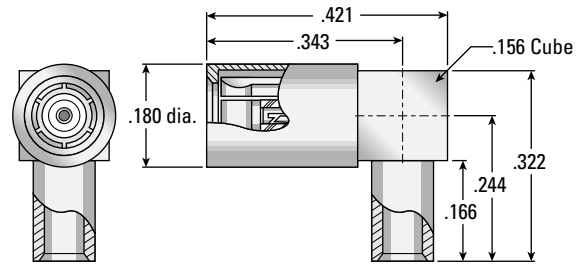

**AEP P/N**  
**7405-1561-0XX\***

## Straight Cable Jacks

**Crimp type for flexible cable**

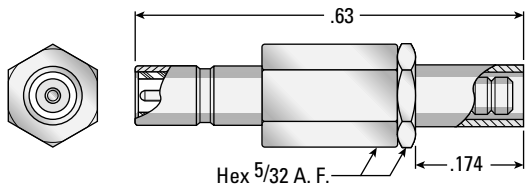

**AEP P/N**  
**7201-1571-0XX\***

**Solder type for semi-rigid cable**

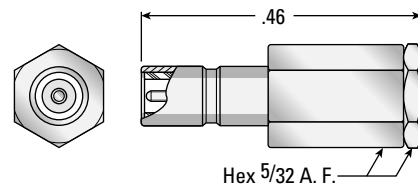

**AEP P/N**  
**7201-1541-0XX\***

**\*Substitute the appropriate cable group number for "XX" when ordering:**

GROUP	CABLE TYPES	GROUP	CABLE TYPES	GROUP	CABLE TYPES
02	RG178, RG196, M17/93, M17/169	05	RG178DS, RG196DS	19	RG174DS, RG316DS, M17/151, M17/152, Times RD-316
03	RG174, RG179, RG316, M17/113, M17/119, M17/172, M17/189	10	.085" semi-rigid, RG405, M17/133	21	.056" semi-rigid
		11	.047" semi-rigid, M17/151		

Cable assembly instructions are shipped with each connector.



**APPLIED ENGINEERING PRODUCTS**

(203) 776-2813 • FAX (203) 776-8294 [www.aep.us](http://www.aep.us) • [aepsales@aep.us](mailto:aepsales@aep.us)



# SSMB Cable Connectors

## Right Angle Cable Jacks

### Crimp type for flexible cable

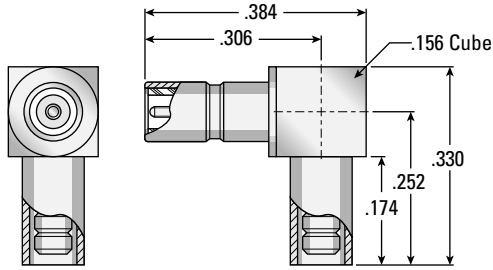

AEP P/N  
7441-1521-0XX\*

### Solder type for semi-rigid cable

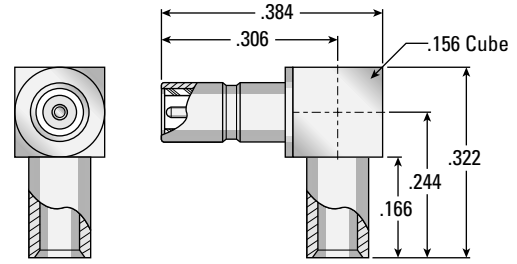

AEP P/N  
7441-1561-0XX\*

## Straight Bulkhead Mounted Cable Jacks (.093" max panel thickness)

### Crimp type for flexible cable

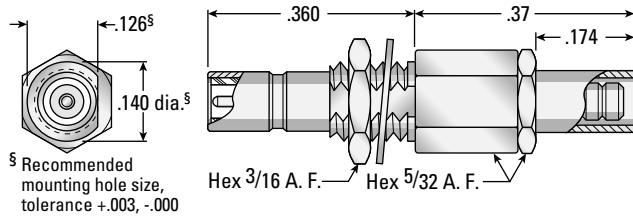

§ Recommended mounting hole size, tolerance +.003, -.000

AEP P/N  
7203-1571-0XX\*

### Solder type for semi-rigid cable

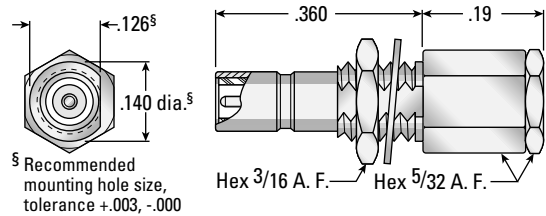

§ Recommended mounting hole size, tolerance +.003, -.000

AEP P/N  
7203-1541-0XX\*

## Right Angle Bulkhead Mounted Cable Jacks (.125" max panel thickness)

### Crimp type for flexible cable

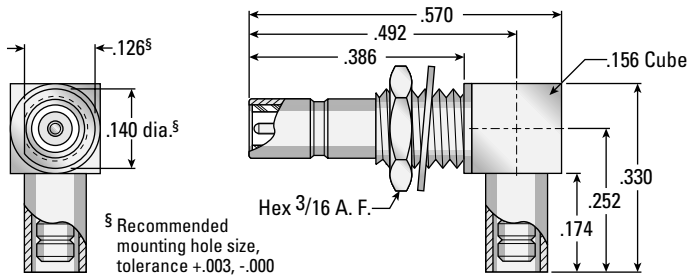

§ Recommended mounting hole size, tolerance +.003, -.000

AEP P/N  
7406-1521-0XX\*

### Solder type for semi-rigid cable

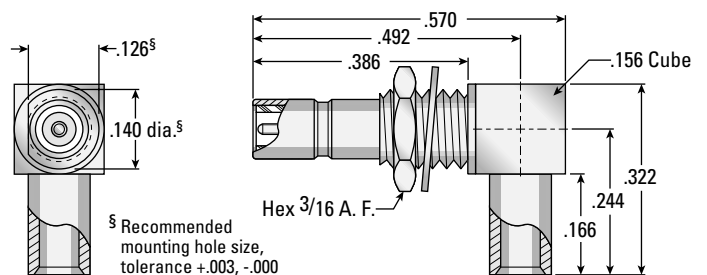

§ Recommended mounting hole size, tolerance +.003, -.000

AEP P/N  
7406-1561-0XX\*

These connectors can be supplied with other mating end lengths to accommodate a wide range of panel thicknesses—contact factory for availability.

\*Substitute the appropriate cable group number for "XX" when ordering:

GROUP	CABLE TYPES	GROUP	CABLE TYPES	GROUP	CABLE TYPES
02	RG178, RG196, M17/93, M17/169	05	RG178DS, RG196DS	19	RG174DS, RG316DS, M17/151, M17/152, Times RD-316
03	RG174, RG179, RG316, M17/113, M17/119, M17/172, M17/189	10	.085" semi-rigid, RG405, M17/133	21	.056" semi-rigid
		11	.047" semi-rigid, M17/151		

Cable assembly instructions are shipped with each connector.



APPLIED ENGINEERING PRODUCTS

(203) 776-2813 • FAX (203) 776-8294 www.aep.us • aepsales@aep.us

# SSMB Bulkhead Mounted Receptacles

## Straight Bulkhead Jack Receptacles (.093" max panel thickness)

**Rear mount**

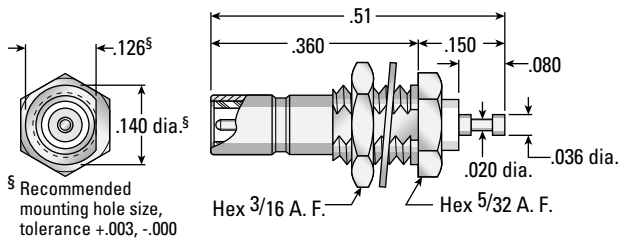

**AEP P/N**  
**7204-1511-000**

**Front mount**

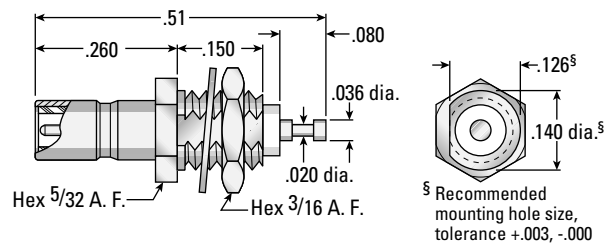

**AEP P/N**  
**7219-1511-000**

## Right Angle Bulkhead Receptacles (.093" max panel thickness)

**Jack type**

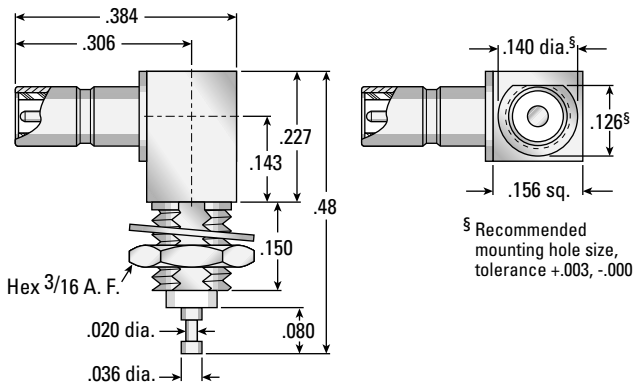

**AEP P/N**  
**7212-1511-000**

**Plug type**

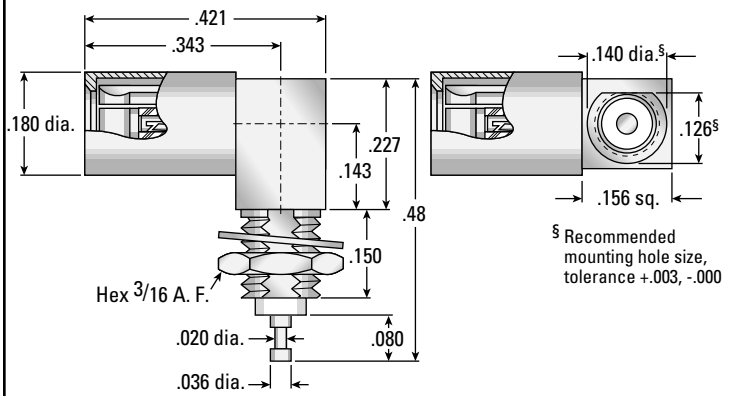

**AEP P/N**  
**7240-1511-000**

## Straight Bulkhead Plug Receptacles

**Front mount**  
(.093" max panel thickness)

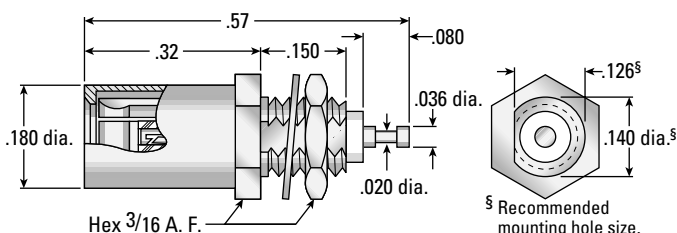

**AEP P/N**  
**7217-1512-000**

**Recessed mount**  
(.200" max panel thickness)

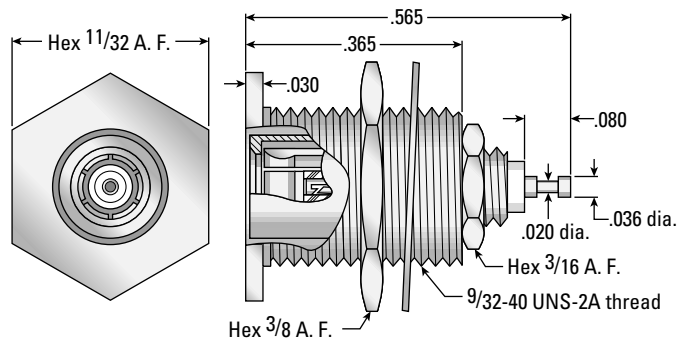

**AEP P/N**  
**7496-1512-000**



# SSMB P.C. Board Receptacles

## Straight P.C. Board Receptacles

### Standard legs

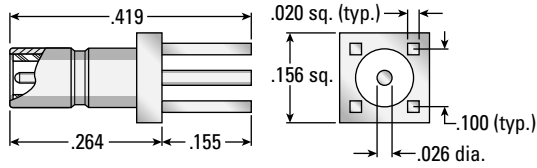

LEG FINISH	AEP P/N	LEG FINISH	AEP P/N
GOLD	7209-1511-000	PRETINNED	7209-1511-012

### Standoff legs

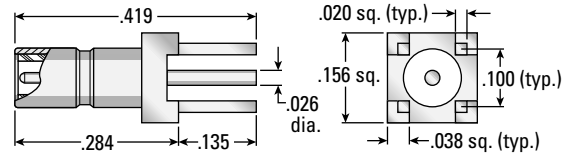

LEG FINISH	AEP P/N	LEG FINISH	AEP P/N
GOLD	7209-1511-011	PRETINNED	7209-1511-040

### Surface mount

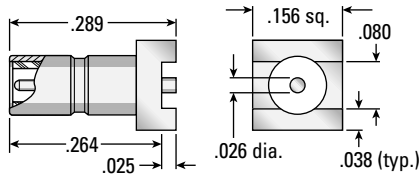

LEG FINISH	AEP P/N
GOLD	7209-1511-015

### Edge mount

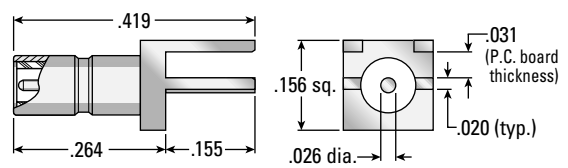

LEG FINISH	AEP P/N	LEG FINISH	AEP P/N
GOLD	7209-1511-023	PRETINNED	7209-1511-061

## Right Angle P.C. Board Receptacles

### Standard legs

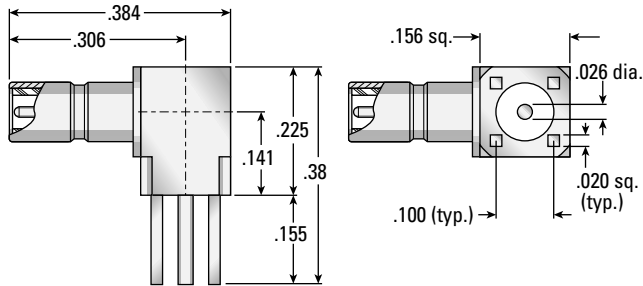

LEG FINISH	AEP P/N	LEG FINISH	AEP P/N
GOLD	7210-1511-000	PRETINNED	7210-1511-012

### Standoff legs

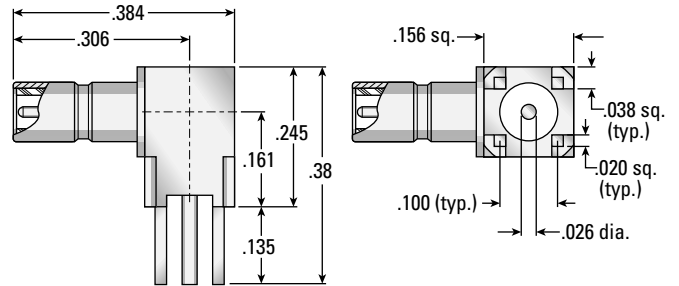

LEG FINISH	AEP P/N	LEG FINISH	AEP P/N
GOLD	7210-1511-050	PRETINNED	7210-1511-040

### Surface mount

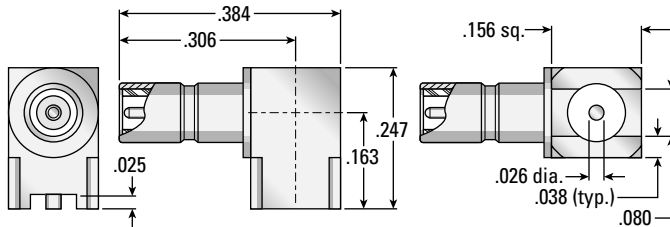

LEG FINISH	AEP P/N
GOLD	7210-1511-015

### Edge mount

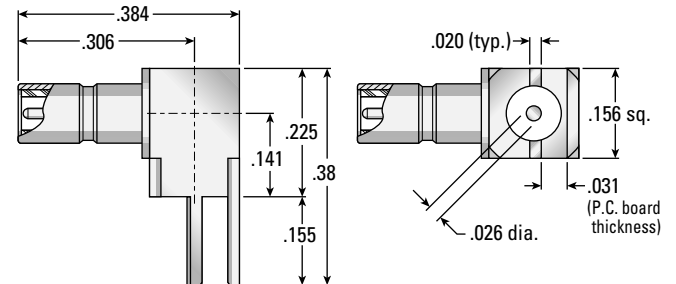

LEG FINISH	AEP P/N	LEG FINISH	AEP P/N
GOLD	7210-1511-060	PRETINNED	7210-1511-061



# SSMB P.C. Board Receptacles

Straight Bulkhead Mounted P.C. Board Receptacles (.125" max panel thickness)

## Standard legs

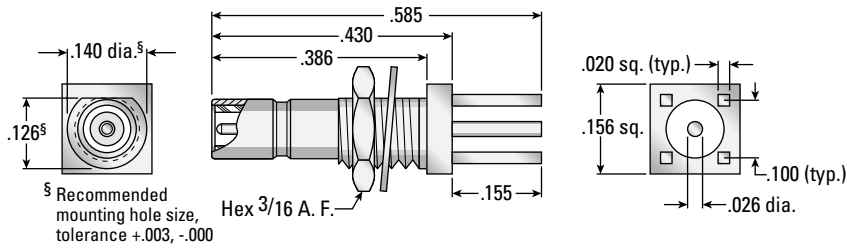

LEG FINISH	AEP P/N
GOLD	7229-1511-000
PRETINNED	7229-1511-012

## Standoff legs

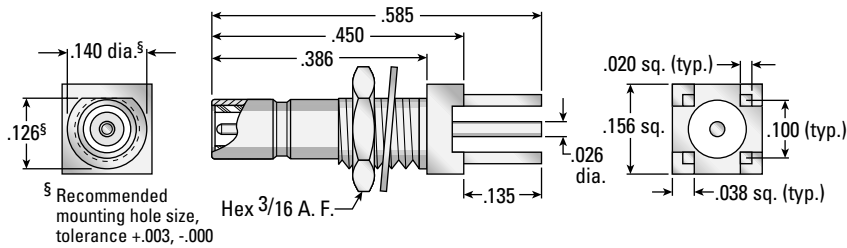

LEG FINISH	AEP P/N
GOLD	7229-1511-050
PRETINNED	7229-1511-040

## Surface mount

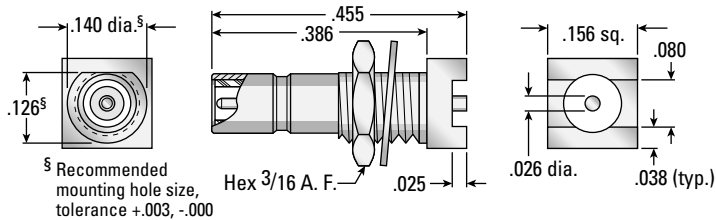

LEG FINISH	AEP P/N
GOLD	7229-1511-015

## Edge mount

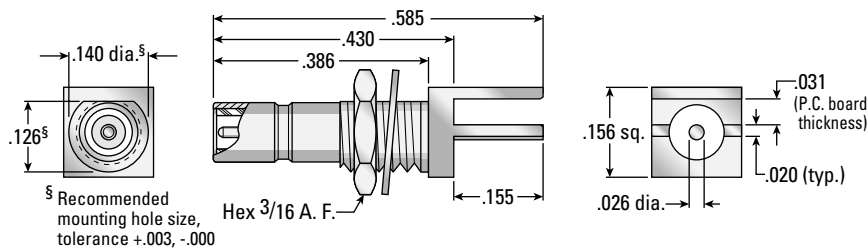

LEG FINISH	AEP P/N
GOLD	7229-1511-060
PRETINNED	7229-1511-061



APPLIED ENGINEERING PRODUCTS

(203) 776-2813 • FAX (203) 776-8294 [www.aep.us](http://www.aep.us) • [aepsales@aep.us](mailto:aepsales@aep.us)

# SSMB P.C. Board Receptacles

Right Angle Bulkhead Mounted P.C. Board Receptacles (.125" max panel thickness)

## Standard legs

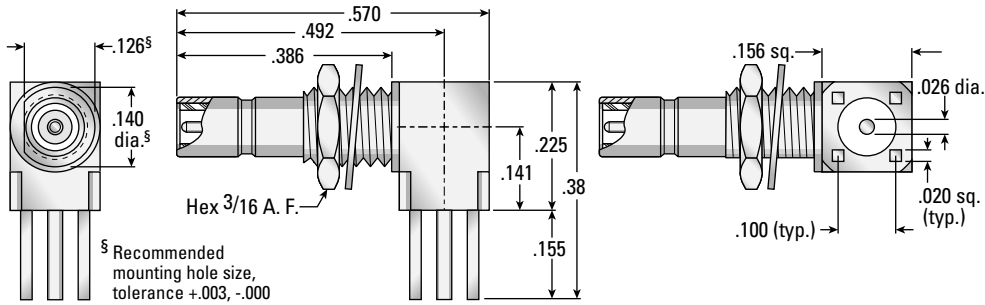

LEG FINISH	AEP P/N
GOLD	7410-1511-000
PRETINNED	7410-1511-012

## Standoff legs

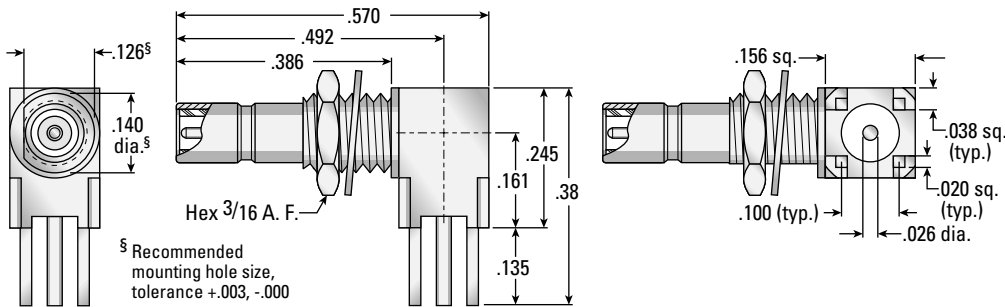

LEG FINISH	AEP P/N
GOLD	7410-1511-050
PRETINNED	7410-1511-040

## Surface mount

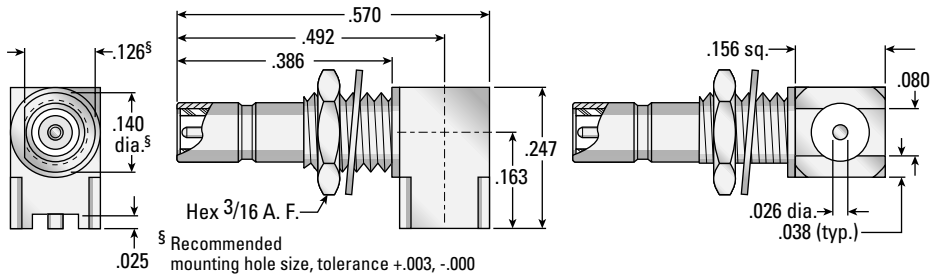

LEG FINISH	AEP P/N
GOLD	7410-1511-015

## Edge mount

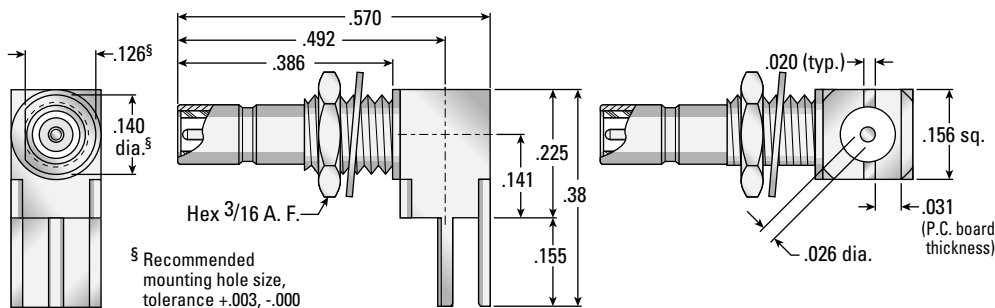

LEG FINISH	AEP P/N
GOLD	7410-1511-060
PRETINNED	7410-1511-061



APPLIED ENGINEERING PRODUCTS

(203) 776-2813 • FAX (203) 776-8294 [www.aep.us](http://www.aep.us) • [aepsales@aep.us](mailto:aepsales@aep.us)

# SSMB P.C. Board Receptacles

## Straight Plug Type P.C. Board Receptacles

### Standard legs

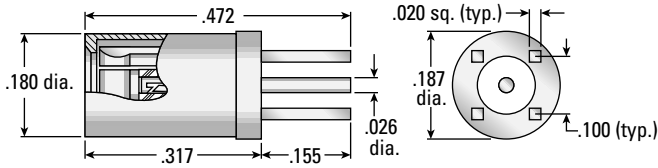

LEG FINISH	AEP P/N	LEG FINISH	AEP P/N
GOLD	7225-1512-000	PRETINNED	7225-1512-012

### Standoff legs

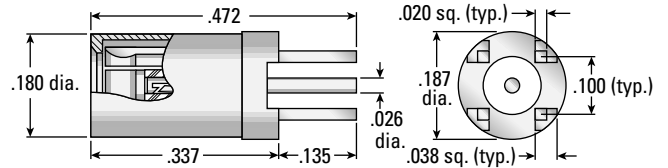

LEG FINISH	AEP P/N	LEG FINISH	AEP P/N
GOLD	7225-1512-050	PRETINNED	7225-1512-040

### Surface mount

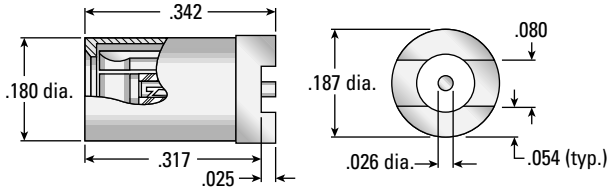

LEG FINISH	AEP P/N
GOLD	7225-1512-015

### Edge mount

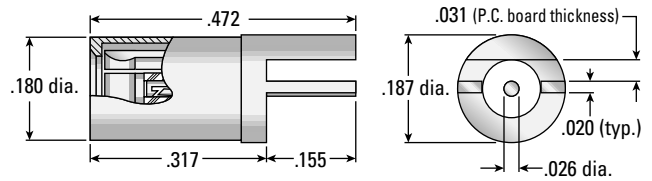

LEG FINISH	AEP P/N	LEG FINISH	AEP P/N
GOLD	7225-1512-060	PRETINNED	7225-1512-061

## Right Angle Plug Type P.C. Board Receptacles

### Standard legs

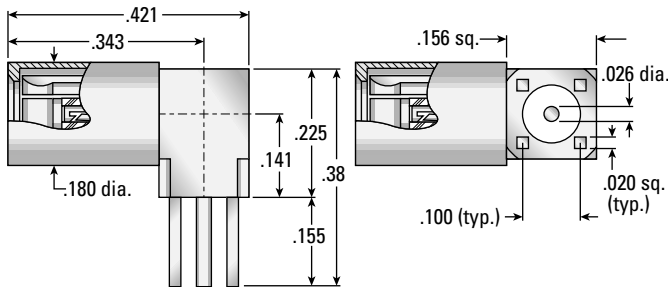

LEG FINISH	AEP P/N	LEG FINISH	AEP P/N
GOLD	7242-1511-000	PRETINNED	7242-1511-012

### Standoff legs

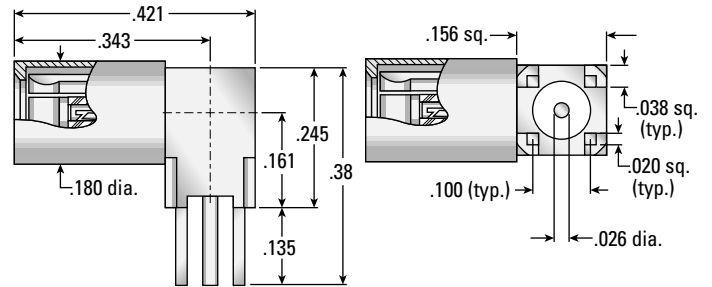

LEG FINISH	AEP P/N	LEG FINISH	AEP P/N
GOLD	7242-1511-050	PRETINNED	7242-1511-040

### Surface mount

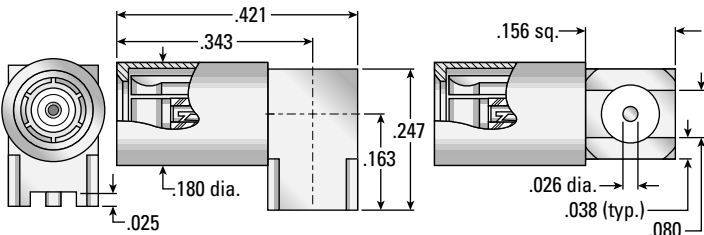

LEG FINISH	AEP P/N
GOLD	7242-1511-015

### Edge mount

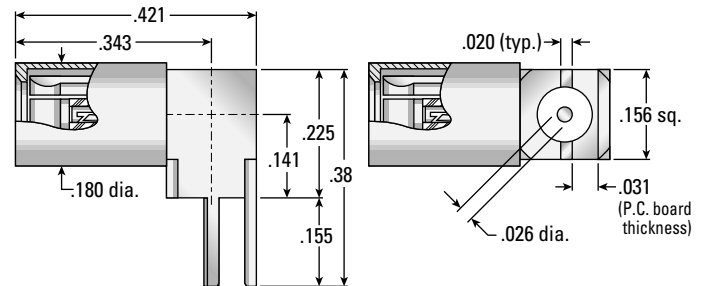

LEG FINISH	AEP P/N	LEG FINISH	AEP P/N
GOLD	7242-1511-060	PRETINNED	7242-1511-061



# SSMB Receptacles and Adapters

## Straight Panel Jack Receptacle (Stainless steel bodies)

### 4-hole flange

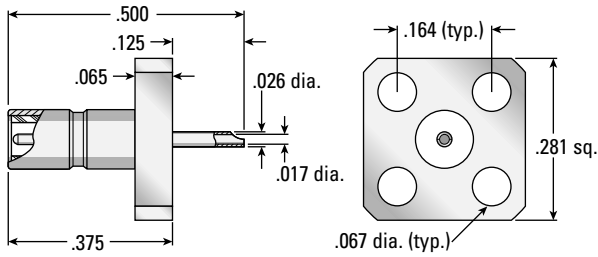

**AEP P/N**  
**7498-1513-000**

### 2-hole flange

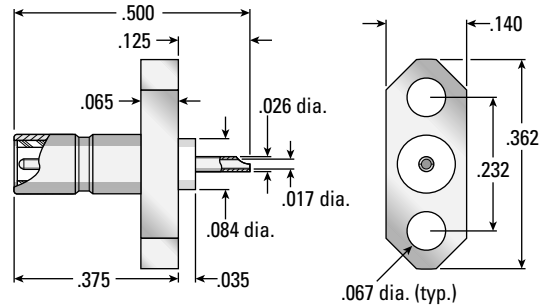

**AEP P/N**  
**7499-1513-000**

## Bulkhead Mounted Adapters

### SSMB jack to SSMB jack

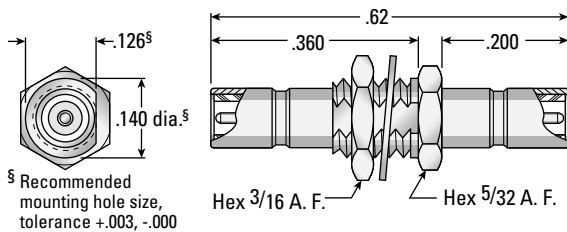

§ Recommended mounting hole size, tolerance +.003, -.000

**AEP P/N**  
**7222-1501-000**

### SSMC jack to SSMB jack

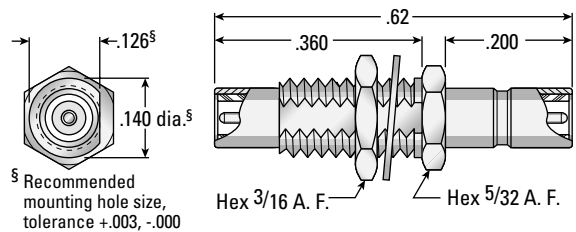

§ Recommended mounting hole size, tolerance +.003, -.000

**AEP P/N**  
**7022-1502-000**

## Adapters Between Series

### N plug to SSMB jack

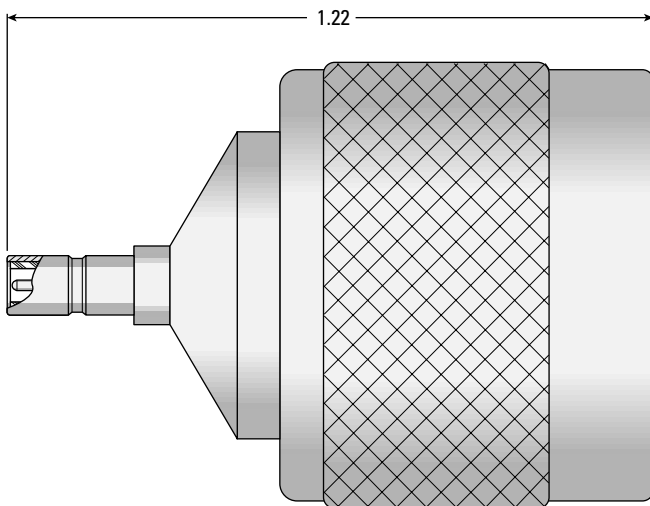

**AEP P/N**  
**5011-1503-000**

### SMA plug to SSMB jack

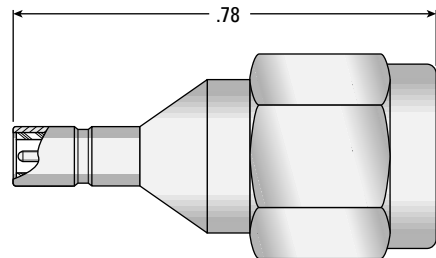

**AEP P/N**  
**5937-1503-000**



# SSLB Cable Connectors

## Straight Cable Plugs

**Crimp type for flexible cable**

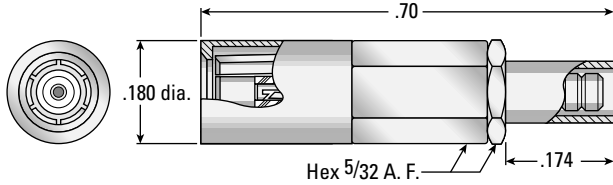

**AEP P/N**  
**7302-1572-0XX\***

**Solder type for semi-rigid cable**

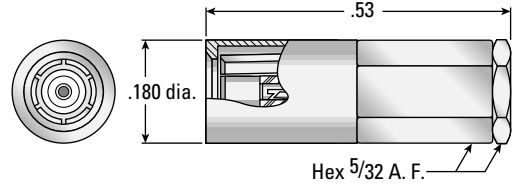

**AEP P/N**  
**7302-1542-0XX\***

## Right Angle Cable Plugs

**Crimp type for flexible cable**

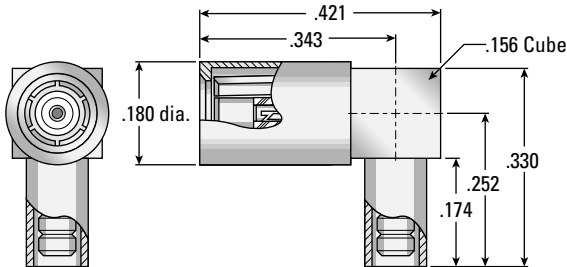

**AEP P/N**  
**7305-1521-0XX\***

**Solder type for semi-rigid cable**

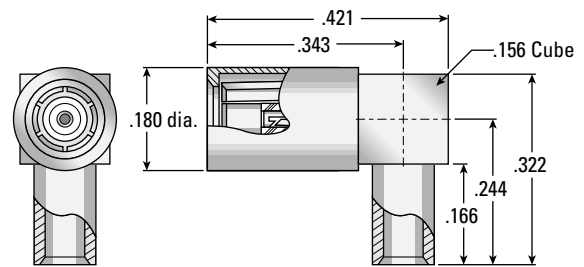

**AEP P/N**  
**7305-1561-0XX\***

## Right Angle Cable Jacks

**Crimp type for flexible cable**

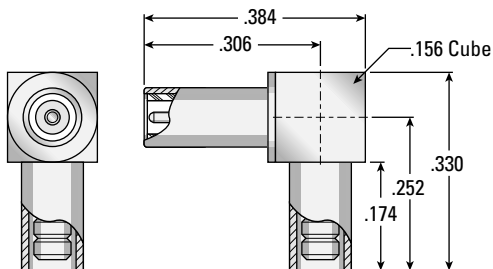

**AEP P/N**  
**7341-1521-0XX\***

**Solder type for semi-rigid cable**

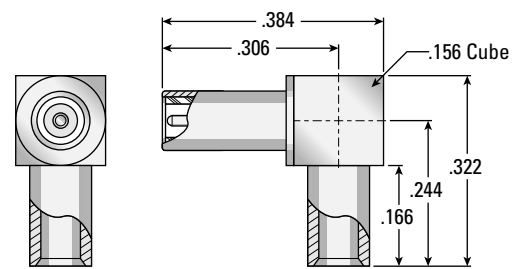

**AEP P/N**  
**7341-1561-0XX\***

**\*Substitute the appropriate cable group number for "XX" when ordering:**

GROUP	CABLE TYPES	GROUP	CABLE TYPES	GROUP	CABLE TYPES
02	RG178, RG196, M17/93, M17/169	05	RG178DS, RG196DS	19	RG174DS, RG316DS, M17/151, M17/152, Times RD-316
03	RG174, RG179, RG316, M17/113, M17/119, M17/172, M17/189	10	.085" semi-rigid, RG405, M17/133	21	.056" semi-rigid
		11	.047" semi-rigid, M17/151		

Cable assembly instructions are shipped with each connector.



**APPLIED ENGINEERING PRODUCTS**

(203) 776-2813 • FAX (203) 776-8294 [www.aep.us](http://www.aep.us) • [aepsales@aep.us](mailto:aepsales@aep.us)



# SSLB Cable Connectors

## Straight Bulkhead Mounted Cable Jacks (.093" max panel thickness)

### Crimp type for flexible cable

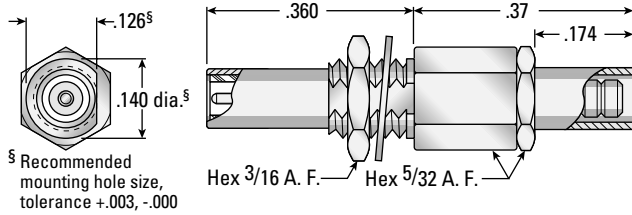

§ Recommended mounting hole size, tolerance +.003, -.000

**AEP P/N**  
**7303-1571-0XX\***

### Solder type for semi-rigid cable

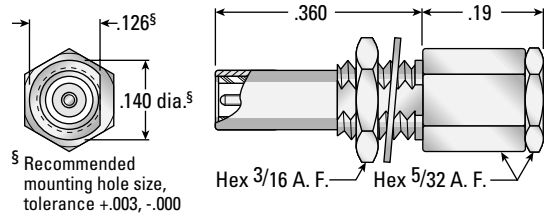

§ Recommended mounting hole size, tolerance +.003, -.000

**AEP P/N**  
**7303-1541-0XX\***

## Vibration-Proof Float Mounted Plug (See page 2 for details)

### Straight—crimp type for flexible cable

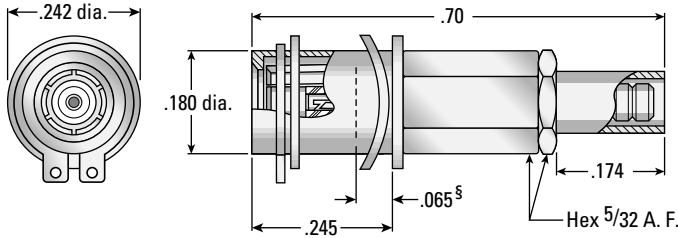

§ From internal mating plane (end of mating connector when fully engaged) to rear of panel

PANEL THICKNESS	AEP P/N
.050	7332-1572-0XX*
.093	7332-1572-3XX*

## Vibration-Proof Float Mounted Plug (See page 2 for details)

### Right angle—crimp type for flexible cable

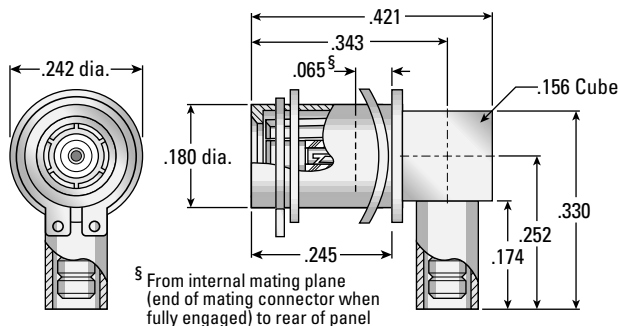

§ From internal mating plane (end of mating connector when fully engaged) to rear of panel

PANEL THICKNESS	AEP P/N
.050	7335-1521-0XX*
.093	7335-1521-3XX*

**\*Substitute the appropriate cable group number for "XX" when ordering:**

GROUP	CABLE TYPES	GROUP	CABLE TYPES	GROUP	CABLE TYPES
02	RG178, RG196, M17/93, M17/169	05	RG178DS, RG196DS	19	RG174DS, RG316DS, M17/151, M17/152, Times RD-316
03	RG174, RG179, RG316, M17/113, M17/119, M17/172, M17/189	10	.085" semi-rigid, RG405, M17/133		
		11	.047" semi-rigid, M17/151	21	.056" semi-rigid

Cable assembly instructions are shipped with each connector.



**APPLIED ENGINEERING PRODUCTS**

(203) 776-2813 • FAX (203) 776-8294 [www.aep.us](http://www.aep.us) • [aepsales@aep.us](mailto:aepsales@aep.us)

# SSLB Bulkhead Mounted Receptacles

## Bulkhead Jack Receptacles (.093" max panel thickness)

### Straight

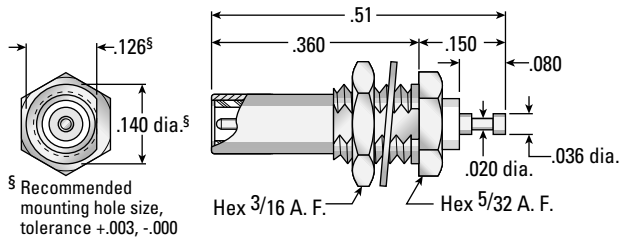

**AEP P/N**  
**7304-1511-000**

### Right angle

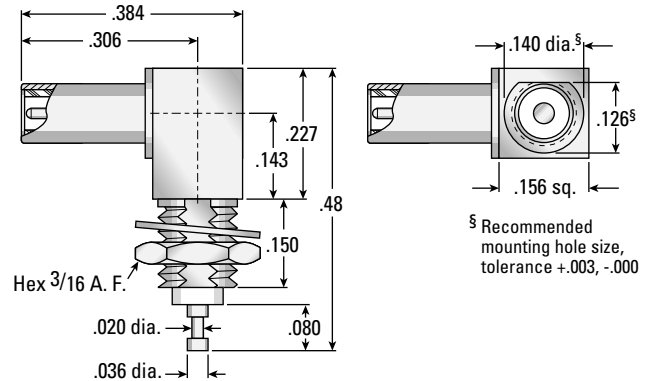

**AEP P/N**  
**7312-1511-000**

## Bulkhead Plug Receptacles (.093" max panel thickness)

### Straight

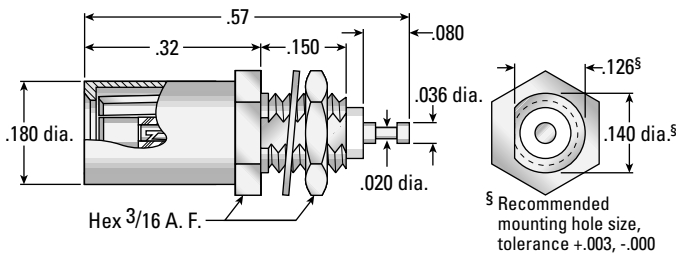

**AEP P/N**  
**7317-1512-000**

### Right angle

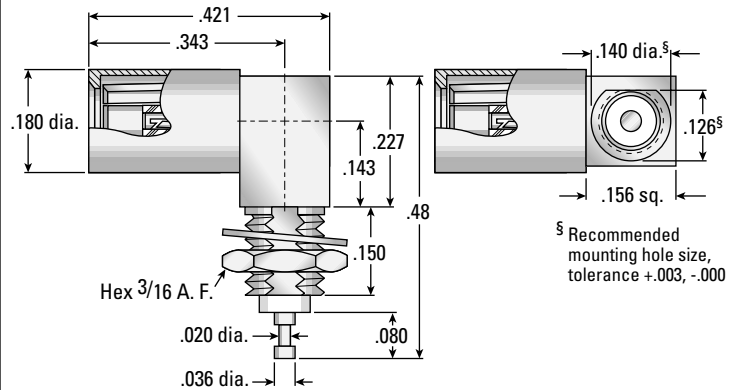

**AEP P/N**  
**7340-1511-000**

## Straight Bulkhead Plug Receptacle (.250" max panel thickness)

### Recessed mount

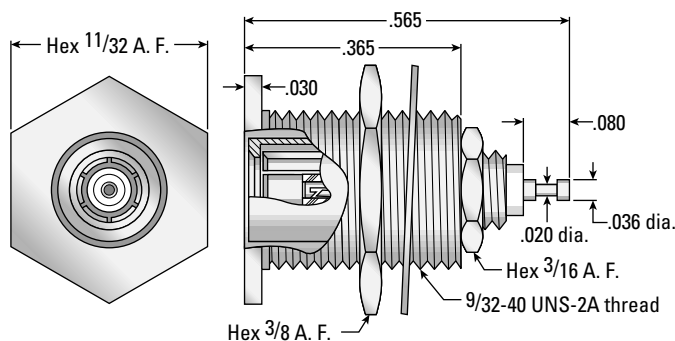

**AEP P/N**  
**7396-1512-000**



**APPLIED ENGINEERING PRODUCTS**

(203) 776-2813 • FAX (203) 776-8294 [www.aep.us](http://www.aep.us) • [aepsales@aep.us](mailto:aepsales@aep.us)

# SSLB P.C. Board Receptacles

## Straight P.C. Board Receptacles

### Standard legs

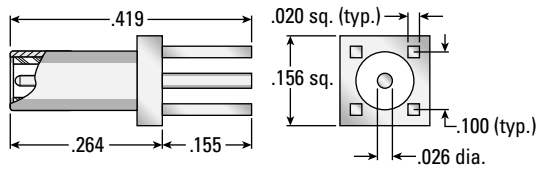

LEG FINISH	AEP P/N
GOLD	7309-1511-000

LEG FINISH	AEP P/N
PRETINNED	7309-1511-012

### Standoff legs

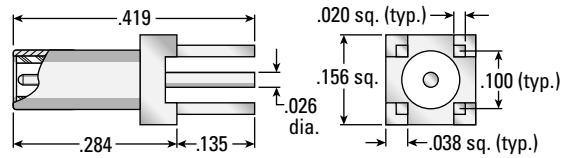

LEG FINISH	AEP P/N
GOLD	7309-1511-050

LEG FINISH	AEP P/N
PRETINNED	7309-1511-040

### Surface mount

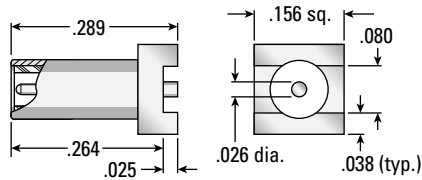

LEG FINISH	AEP P/N
GOLD	7309-1511-015

### Edge mount

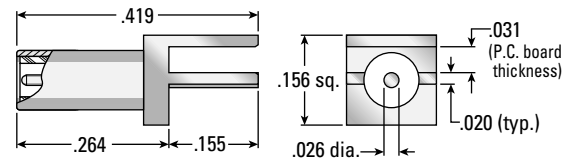

LEG FINISH	AEP P/N
GOLD	7309-1511-060

LEG FINISH	AEP P/N
PRETINNED	7309-1511-061

## Right Angle P.C. Board Receptacles

### Standard legs

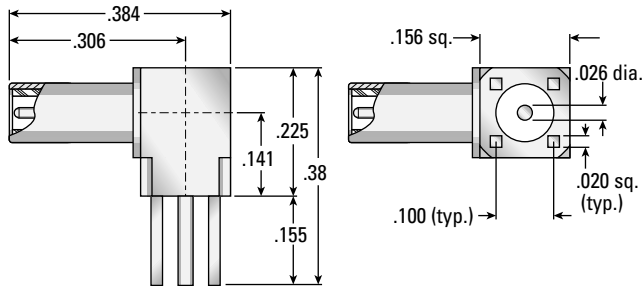

LEG FINISH	AEP P/N
GOLD	7310-1511-000

LEG FINISH	AEP P/N
PRETINNED	7310-1511-012

### Standoff legs

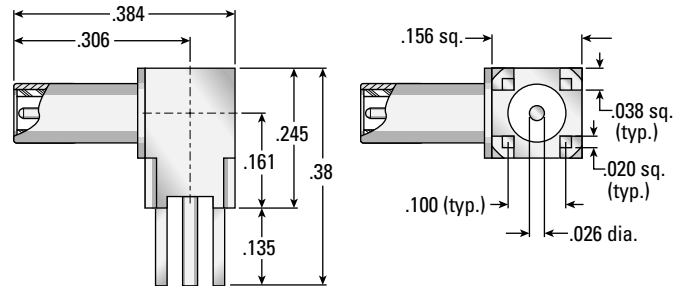

LEG FINISH	AEP P/N
GOLD	7310-1511-050

LEG FINISH	AEP P/N
PRETINNED	7310-1511-040

### Surface mount

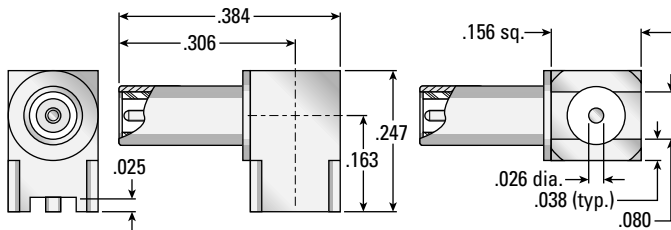

LEG FINISH	AEP P/N
GOLD	7310-1511-015

### Edge mount

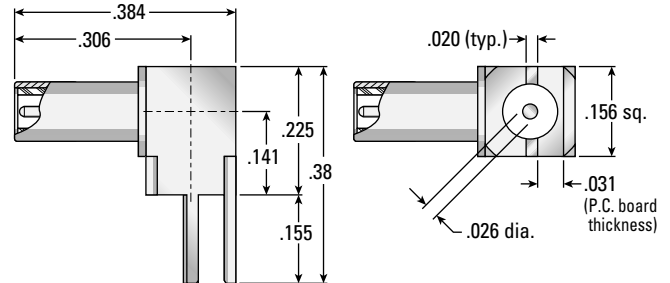

LEG FINISH	AEP P/N
GOLD	7310-1511-060

LEG FINISH	AEP P/N
PRETINNED	7310-1511-061



# SSLB P.C. Board Receptacles

## Straight Plug Type P.C. Board Receptacles

### Standard legs

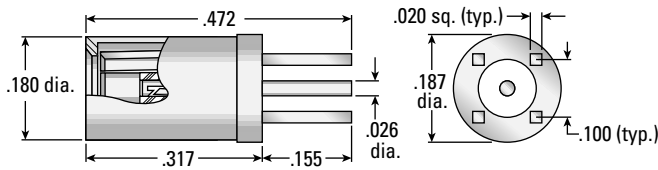

LEG FINISH	AEP P/N
GOLD	7325-1512-000

LEG FINISH	AEP P/N
PRETINNED	7325-1512-012

### Standoff legs

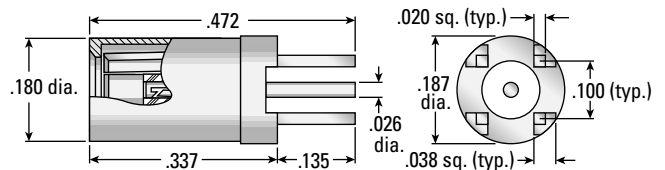

LEG FINISH	AEP P/N
GOLD	7325-1512-050

LEG FINISH	AEP P/N
PRETINNED	7325-1512-040

### Surface mount

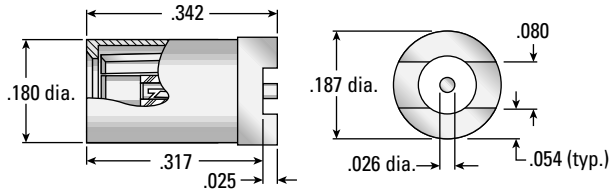

LEG FINISH	AEP P/N
GOLD	7325-1512-015

### Edge mount

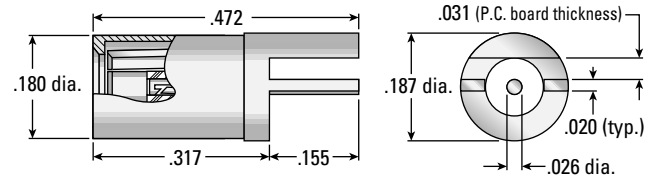

LEG FINISH	AEP P/N
GOLD	7325-1512-060

LEG FINISH	AEP P/N
PRETINNED	7325-1512-061

## Right Angle Plug Type P.C. Board Receptacles

### Standard legs

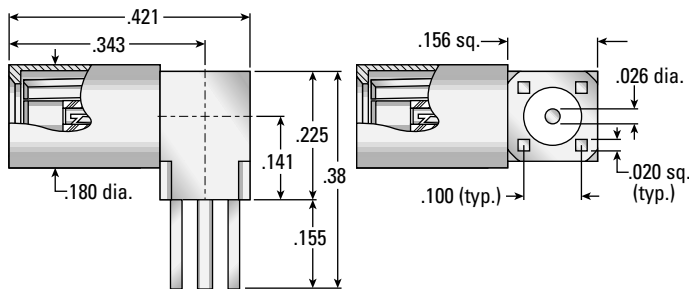

LEG FINISH	AEP P/N
GOLD	7342-1511-000

LEG FINISH	AEP P/N
PRETINNED	7342-1511-012

### Standoff legs

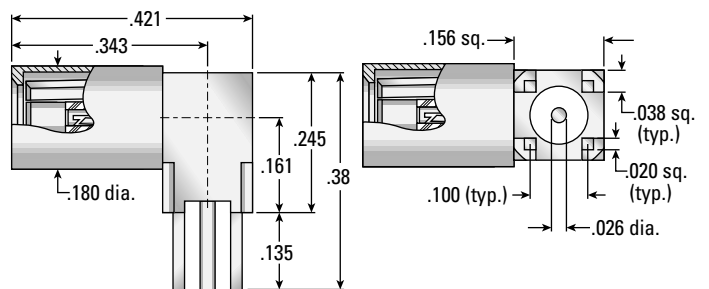

LEG FINISH	AEP P/N
GOLD	7342-1511-050

LEG FINISH	AEP P/N
PRETINNED	7342-1511-040

### Surface mount

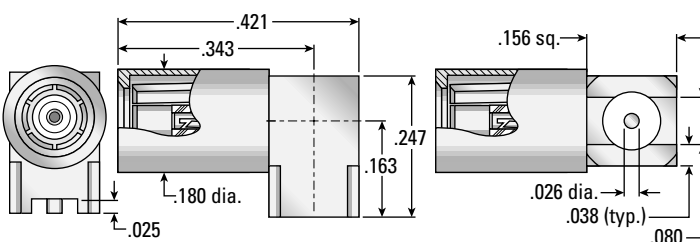

LEG FINISH	AEP P/N
GOLD	7342-1511-015

### Edge mount

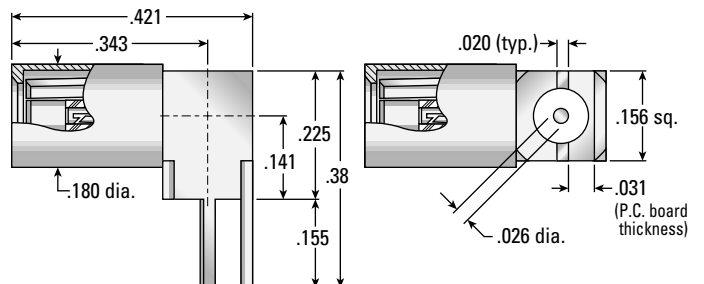

LEG FINISH	AEP P/N
GOLD	7342-1511-060

LEG FINISH	AEP P/N
PRETINNED	7342-1511-061



# SSMC Cable Connectors

## Straight Cable Plugs

**Crimp type for flexible cable**

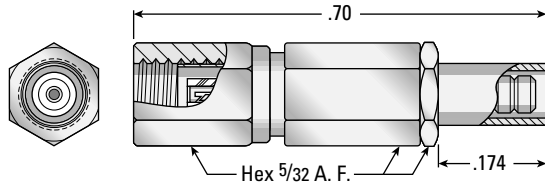

**AEP P/N**  
**7002-1572-0XX\***

**Solder type for semi-rigid cable**

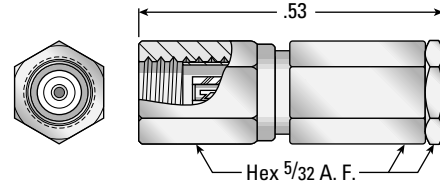

**AEP P/N**  
**7002-1542-0XX\***

## Right Angle Cable Plugs

**Crimp type for flexible cable**

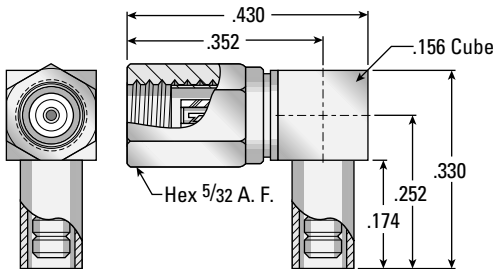

**AEP P/N**  
**7105-1521-0XX\***

**Solder type for semi-rigid cable**

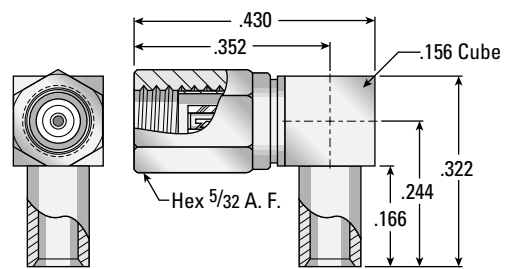

**AEP P/N**  
**7105-1561-0XX\***

## Straight Cable Jacks

**Crimp type for flexible cable**

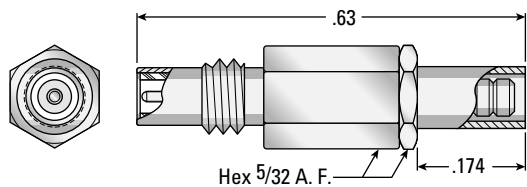

**AEP P/N**  
**7101-1571-0XX\***

**Solder type for semi-rigid cable**

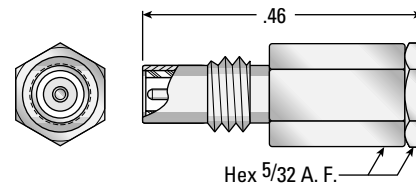

**AEP P/N**  
**7101-1541-0XX\***

**\*Substitute the appropriate cable group number for "XX" when ordering:**

GROUP	CABLE TYPES	GROUP	CABLE TYPES	GROUP	CABLE TYPES
02	RG178, RG196, M17/93, M17/169	05	RG178DS, RG196DS	19	RG174DS, RG316DS, M17/151, M17/152, Times RD-316
03	RG174, RG179, RG316, M17/113, M17/119, M17/172, M17/189	10	.085" semi-rigid, RG405, M17/133	21	.056" semi-rigid
		11	.047" semi-rigid, M17/151		

Cable assembly instructions are shipped with each connector.



**APPLIED ENGINEERING PRODUCTS**

(203) 776-2813 • FAX (203) 776-8294 [www.aep.us](http://www.aep.us) • [aepsales@aep.us](mailto:aepsales@aep.us)

# SSMC Cable Connectors

## Right Angle Cable Jacks

### Crimp type for flexible cable

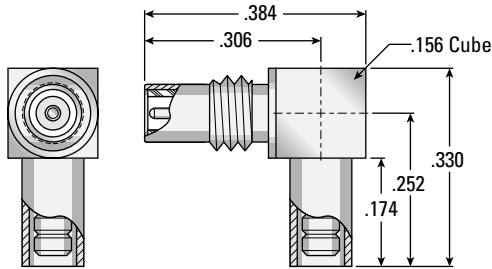

AEP P/N  
7141-1521-0XX\*

### Solder type for semi-rigid cable

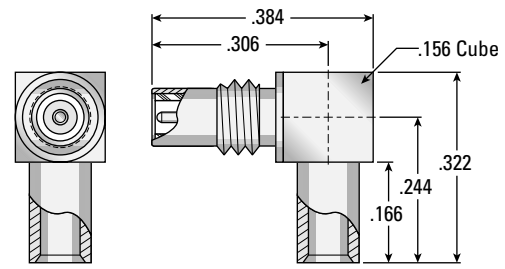

AEP P/N  
7141-1561-0XX\*

## Straight Bulkhead Mounted Cable Jacks (.093" max panel thickness)

### Crimp type for flexible cable

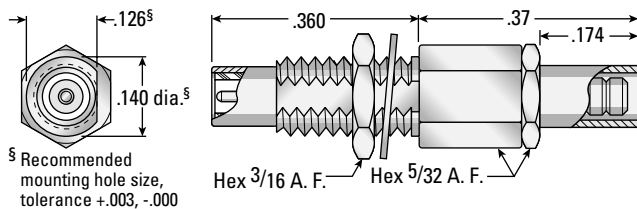

AEP P/N  
7003-1572-0XX\*

### Solder type for semi-rigid cable

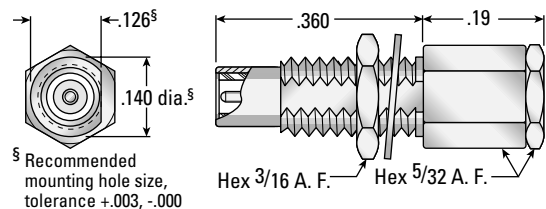

AEP P/N  
7003-1542-0XX\*

## Right Angle Bulkhead Mounted Cable Jacks (.125" max panel thickness)

### Crimp type for flexible cable

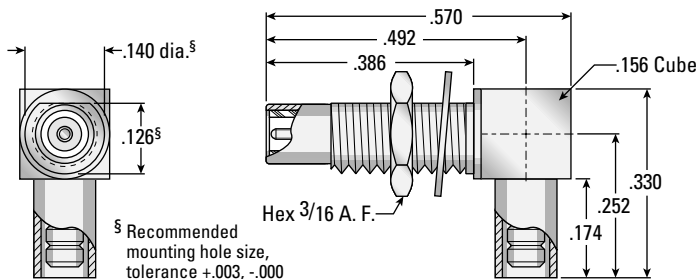

AEP P/N  
7106-1521-0XX\*

### Solder type for semi-rigid cable

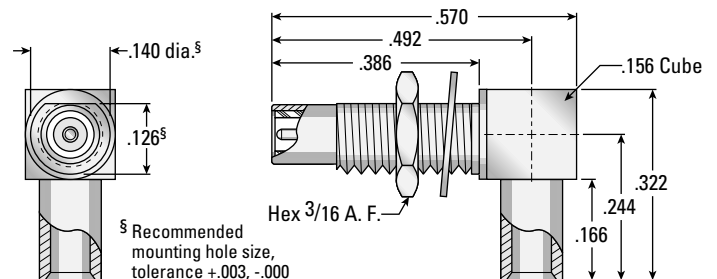

AEP P/N  
7106-1561-0XX\*

\*Substitute the appropriate cable group number for "XX" when ordering:

GROUP	CABLE TYPES	GROUP	CABLE TYPES	GROUP	CABLE TYPES
02	RG178, RG196, M17/93, M17/169	05	RG178DS, RG196DS	19	RG174DS, RG316DS, M17/151, M17/152, Times RD-316
03	RG174, RG179, RG316, M17/113, M17/119, M17/172, M17/189	10	.085" semi-rigid, RG405, M17/133	21	.056" semi-rigid
		11	.047" semi-rigid, M17/151		

Cable assembly instructions are shipped with each connector.



APPLIED ENGINEERING PRODUCTS

(203) 776-2813 • FAX (203) 776-8294 www.aep.us • aepsales@aep.us

# SSMC Bulkhead Mounted Receptacles

## Straight Bulkhead Jack Receptacles (.093" max panel thickness)

**Rear mount**

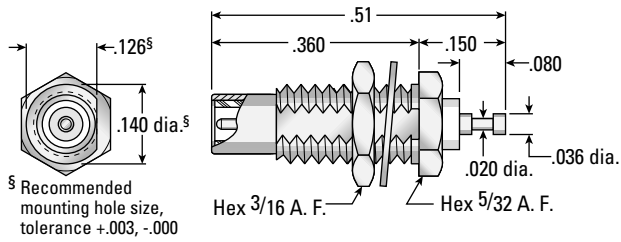

**AEP P/N**  
**7004-1512-000**

**Front mount**

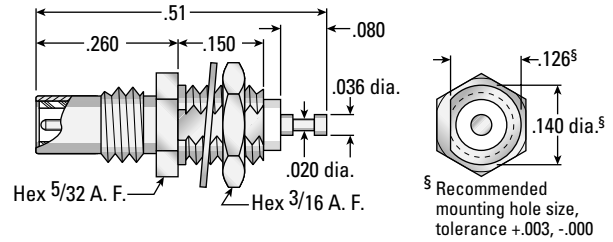

**AEP P/N**  
**7119-1512-000**

## Right Angle Bulkhead Receptacles (.093" max panel thickness)

**Jack type**

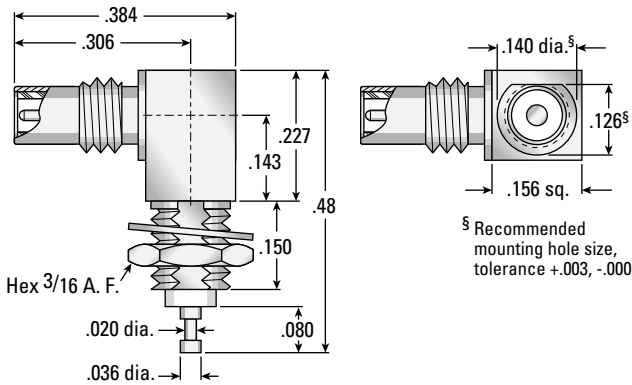

**AEP P/N**  
**7012-1511-000**

**Plug type**

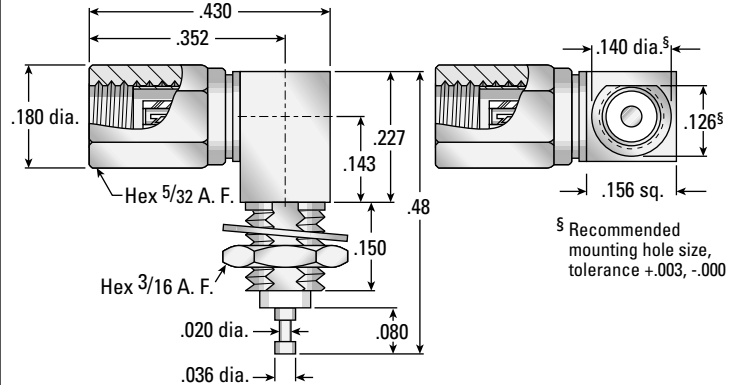

**AEP P/N**  
**7040-1511-000**

## Straight Bulkhead Plug Receptacle

**Front mount (.093" max panel thickness)**

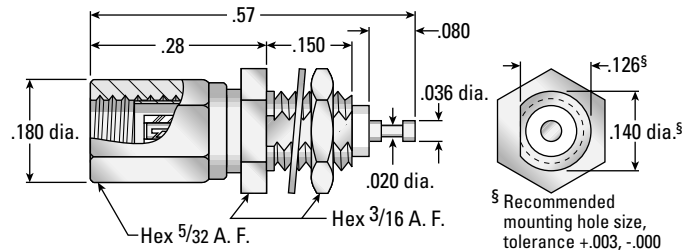

**AEP P/N**  
**7017-1512-000**



# SSMC P.C. Board Receptacles

## Straight P.C. Board Receptacles

### Standard legs

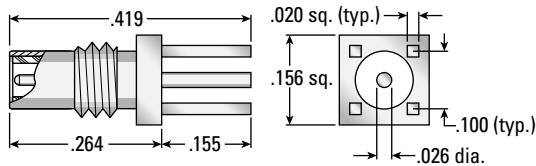

LEG FINISH	AEP P/N	LEG FINISH	AEP P/N
GOLD	7009-1511-000	PRETINNED	7009-1511-040

### Standoff legs

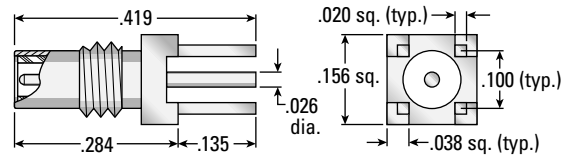

LEG FINISH	AEP P/N	LEG FINISH	AEP P/N
GOLD	7009-1511-050	PRETINNED	7009-1511-041

### Surface mount

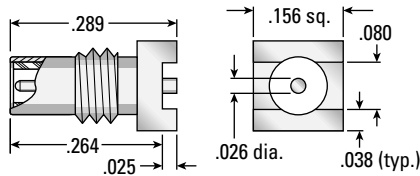

LEG FINISH	AEP P/N
GOLD	7009-1511-004

### Edge mount

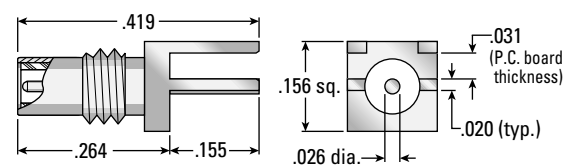

LEG FINISH	AEP P/N	LEG FINISH	AEP P/N
GOLD	7009-1511-005	PRETINNED	7009-1511-061

## Right Angle P.C. Board Receptacles

### Standard legs

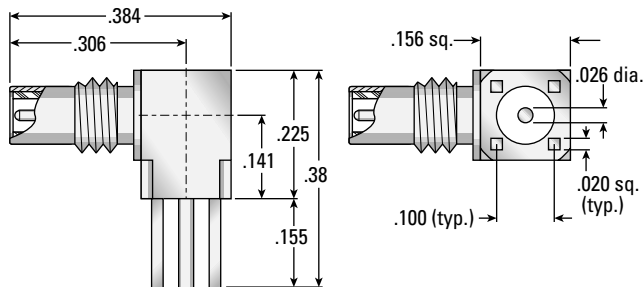

LEG FINISH	AEP P/N	LEG FINISH	AEP P/N
GOLD	7010-1511-000	PRETINNED	7010-1511-040

### Standoff legs

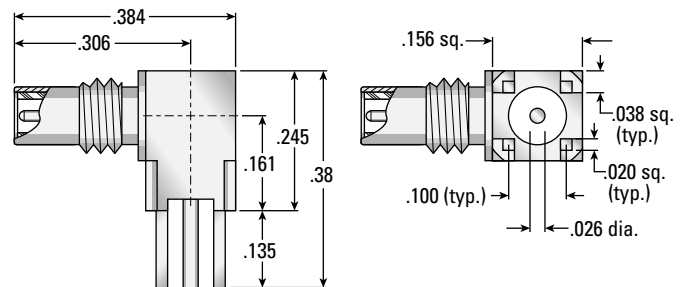

LEG FINISH	AEP P/N	LEG FINISH	AEP P/N
GOLD	7010-1511-050	PRETINNED	7010-1511-041

### Surface mount

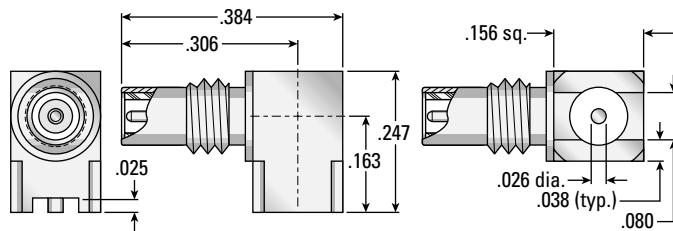

LEG FINISH	AEP P/N
GOLD	7010-1511-015

### Edge mount

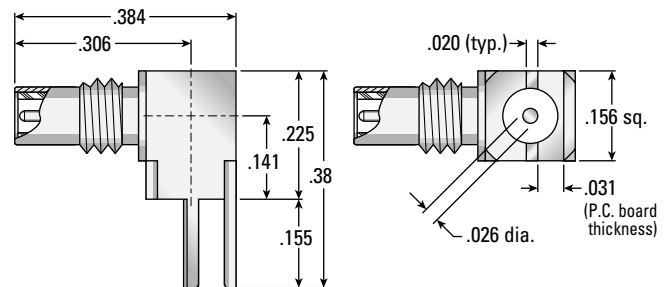

LEG FINISH	AEP P/N	LEG FINISH	AEP P/N
GOLD	7010-1511-060	PRETINNED	7010-1511-061





# SSMC P.C. Board Receptacles

Straight Bulkhead Mounted P.C. Board Receptacles (.125" max panel thickness)

## Standard legs

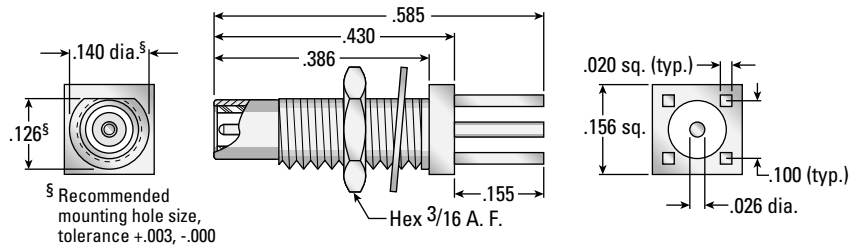

LEG FINISH	AEP P/N
GOLD	7029-1511-000
PRETINNED	7029-1511-012

## Standoff legs

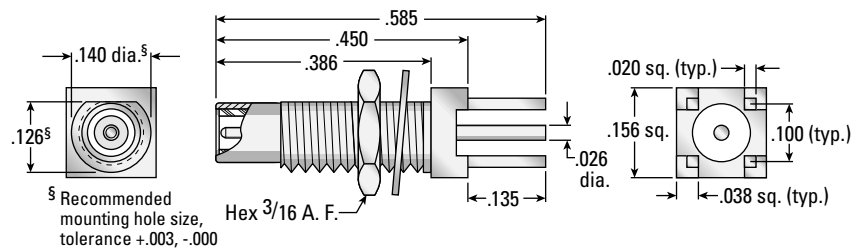

LEG FINISH	AEP P/N
GOLD	7029-1511-050
PRETINNED	7029-1511-040

## Surface mount

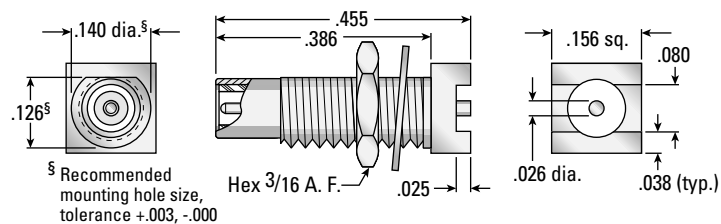

LEG FINISH	AEP P/N
GOLD	7029-1511-015

## Edge mount

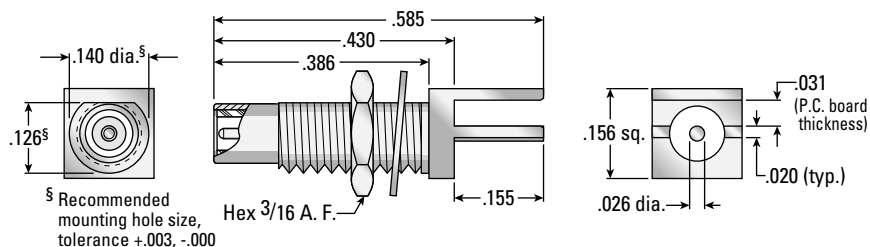

LEG FINISH	AEP P/N
GOLD	7029-1511-060
PRETINNED	7029-1511-061



# SSMC P.C. Board Receptacles

Right Angle Bulkhead Mounted P.C. Board Receptacles (.125" max panel thickness)

## Standard legs

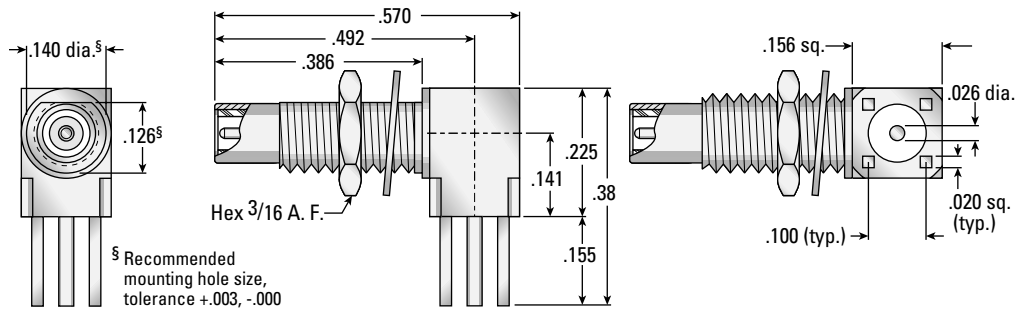

LEG FINISH	AEP P/N
GOLD	7110-1511-000
PRETINNED	7110-1511-012

## Standoff legs

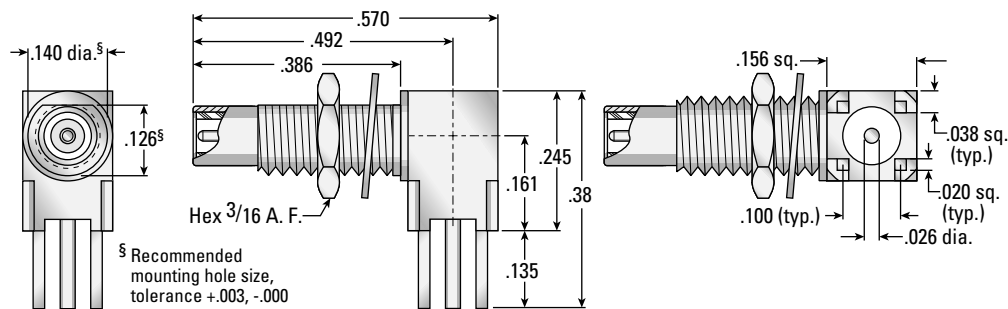

LEG FINISH	AEP P/N
GOLD	7110-1511-050
PRETINNED	7110-1511-040

## Surface mount

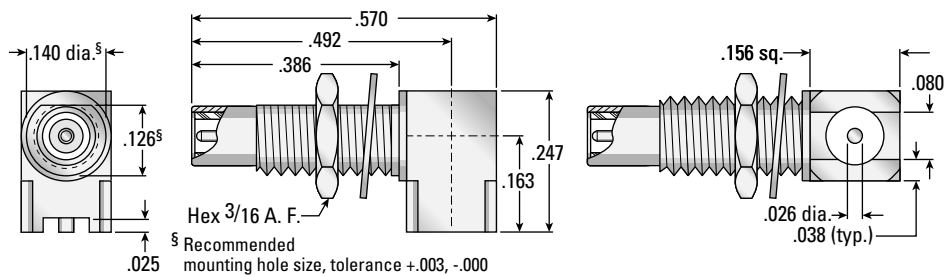

LEG FINISH	AEP P/N
GOLD	7110-1511-015

## Edge mount

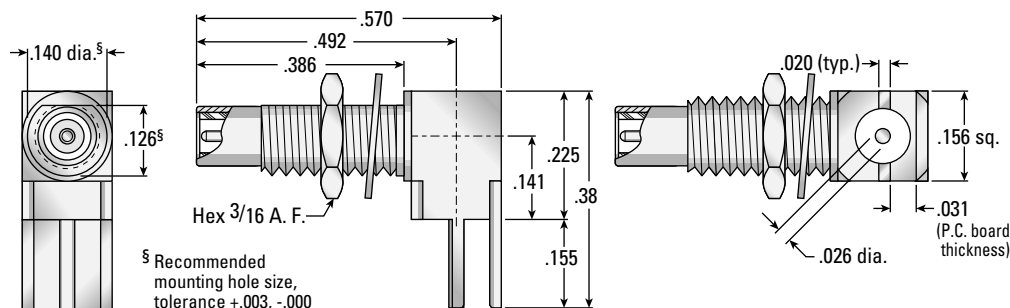

LEG FINISH	AEP P/N
GOLD	7110-1511-060
PRETINNED	7110-1511-061



APPLIED ENGINEERING PRODUCTS

(203) 776-2813 • FAX (203) 776-8294 [www.aep.us](http://www.aep.us) • [aepsales@aep.us](mailto:aepsales@aep.us)

# SSMC P.C. Board Receptacles

## Straight Plug Type P.C. Board Receptacles

### Standard legs

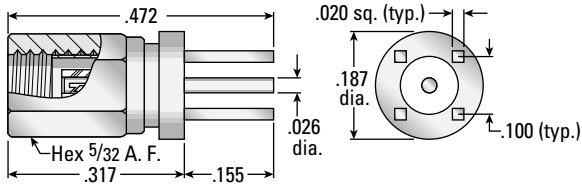

LEG FINISH	AEP P/N	LEG FINISH	AEP P/N
GOLD	7025-1512-000	PRETINNED	7025-1512-012

### Standoff legs

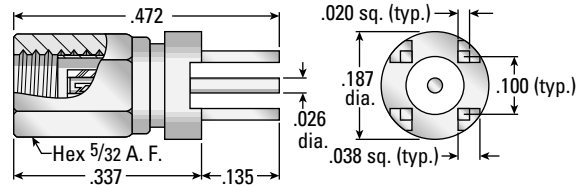

LEG FINISH	AEP P/N	LEG FINISH	AEP P/N
GOLD	7025-1512-050	PRETINNED	7025-1512-040

### Surface mount

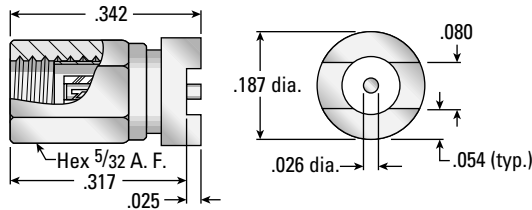

LEG FINISH	AEP P/N
GOLD	7025-1512-015

### Edge mount

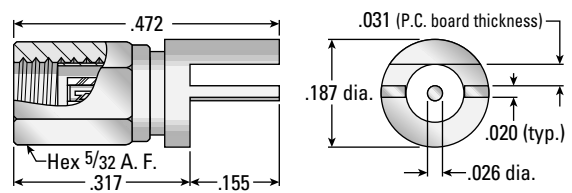

LEG FINISH	AEP P/N	LEG FINISH	AEP P/N
GOLD	7025-1512-060	PRETINNED	7025-1512-061

## Right Angle Plug Type P.C. Board Receptacles

### Standard legs

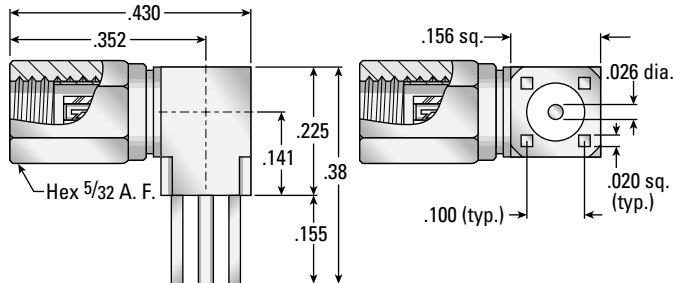

LEG FINISH	AEP P/N	LEG FINISH	AEP P/N
GOLD	7042-1511-000	PRETINNED	7042-1511-012

### Standoff legs

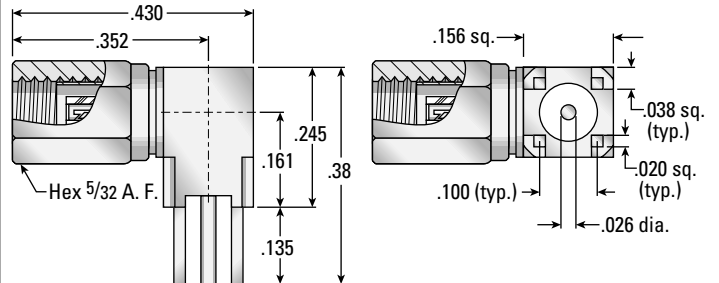

LEG FINISH	AEP P/N	LEG FINISH	AEP P/N
GOLD	7042-1511-050	PRETINNED	7042-1511-040

### Surface mount

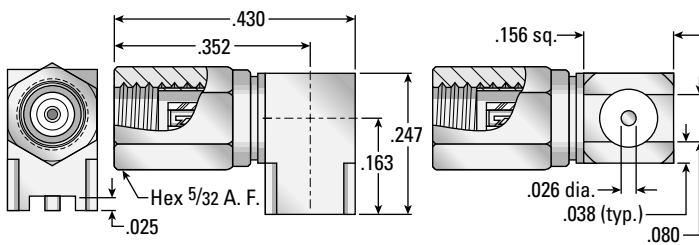

LEG FINISH	AEP P/N
GOLD	7042-1511-015

### Edge mount

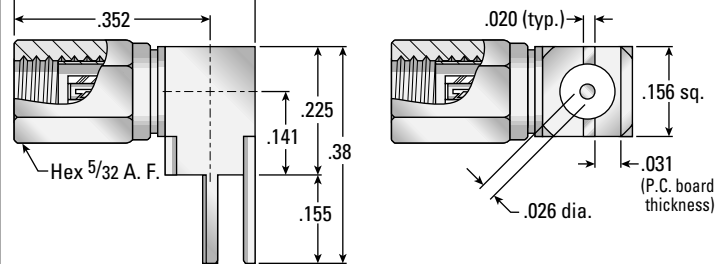

LEG FINISH	AEP P/N	LEG FINISH	AEP P/N
GOLD	7042-1511-060	PRETINNED	7042-1511-061



# SSMC Receptacles and Adapters

## Straight Panel Jack Receptacle (Stainless steel bodies)

**4-hole flange**

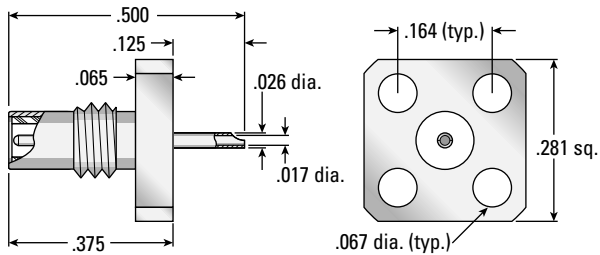

**AEP P/N**  
**7198-1513-000**

**2-hole flange**

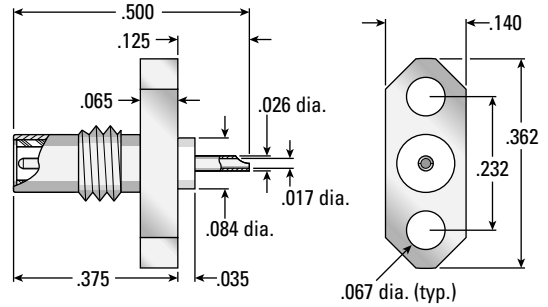

**AEP P/N**  
**7100-1513-000**

## Bulkhead Mounted Adapters

**SSMC jack to SSMC jack**

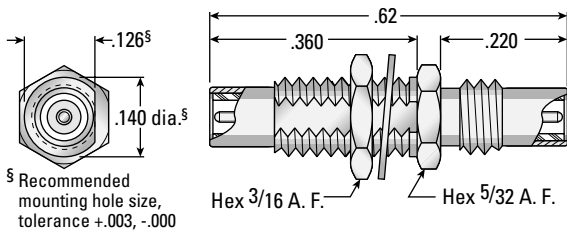

<sup>§</sup> Recommended mounting hole size, tolerance +.003, -.000

**AEP P/N**  
**7122-1502-000**

**SSMC jack to SSMB jack**

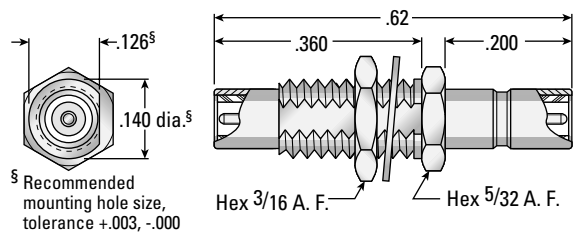

<sup>§</sup> Recommended mounting hole size, tolerance +.003, -.000

**AEP P/N**  
**7022-1502-000**

## Adapters Between Series

**N plug to SSMC jack**

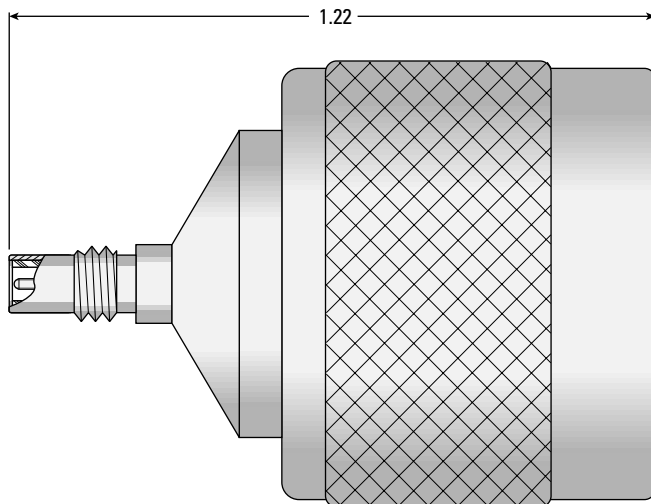

**AEP P/N**  
**5013-1503-000**

**SMA plug to SSMC jack**

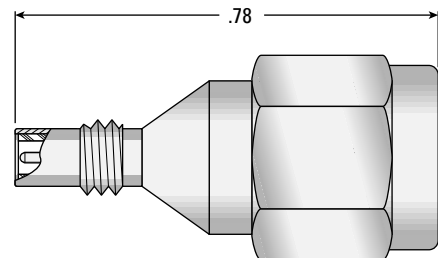

**AEP P/N**  
**5938-1503-000**



# P.C. Board Cable Terminations

## Straight P.C. Board Cable Terminations

### Standard legs

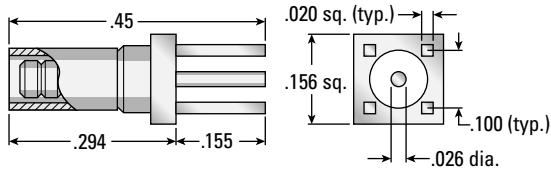

LEG FINISH	AEP P/N
GOLD	7146-1521-0XX

LEG FINISH	AEP P/N
PRETINNED	7146-1521-1XX

### Standoff legs

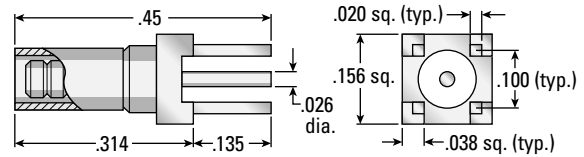

LEG FINISH	AEP P/N
GOLD	7146-1521-2XX

LEG FINISH	AEP P/N
PRETINNED	7146-1521-3XX

### Edge mount

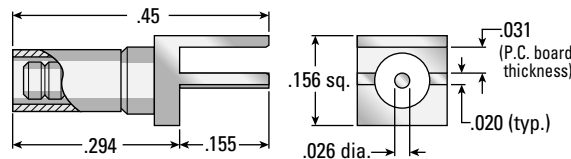

LEG FINISH	AEP P/N
GOLD	7146-1521-4XX
PRETINNED	7146-1521-5XX

## Right Angle P.C. Board Cable Terminations

### Standard legs

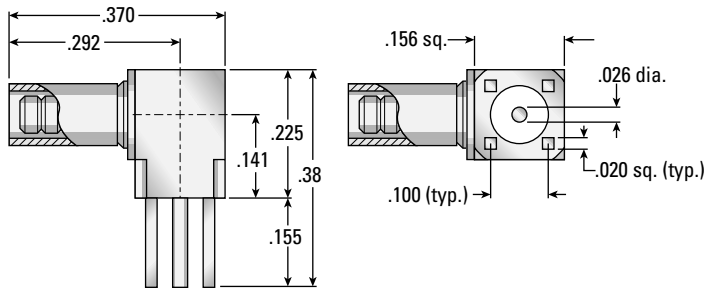

LEG FINISH	AEP P/N
GOLD	7145-1521-0XX

LEG FINISH	AEP P/N
PRETINNED	7145-1521-1XX

### Standoff legs

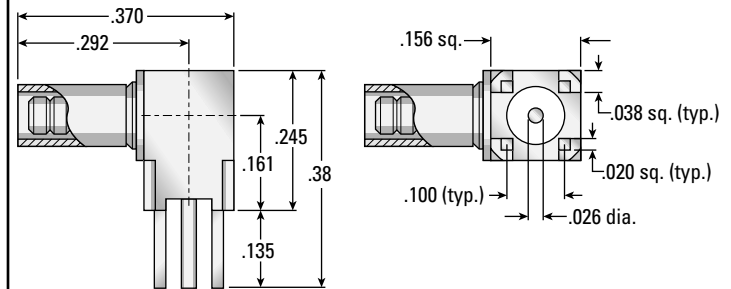

LEG FINISH	AEP P/N
GOLD	7145-1521-2XX

LEG FINISH	AEP P/N
PRETINNED	7145-1521-3XX

### Surface mount

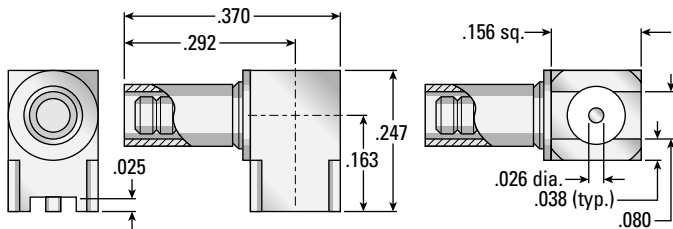

LEG FINISH	AEP P/N
GOLD	7145-1521-6XX

### Edge mount

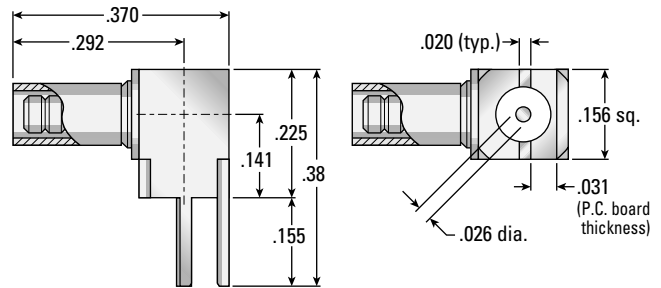

LEG FINISH	AEP P/N
GOLD	7145-1521-4XX

LEG FINISH	AEP P/N
PRETINNED	7145-1521-5XX

\*Substitute the appropriate cable group number for "XX" when ordering:

GROUP	CABLE TYPES	GROUP	CABLE TYPES	GROUP	CABLE TYPES
02	RG178, RG196, M17/93, M17/169	05	RG178DS, RG196DS	19	RG174DS, RG316DS, M17/151, M17/152, Times RD-316
03	RG174, RG179, RG316, M17/113, M17/119, M17/172, M17/189	10	.085" semi-rigid, RG405, M17/133	21	.056" semi-rigid
		11	.047" semi-rigid, M17/151		

Cable assembly instructions are shipped with each connector.



APPLIED ENGINEERING PRODUCTS

(203) 776-2813 • FAX (203) 776-8294 [www.aep.us](http://www.aep.us) • [aepsales@aep.us](mailto:aepsales@aep.us)

# Assembly Tooling

## Crimp Tool

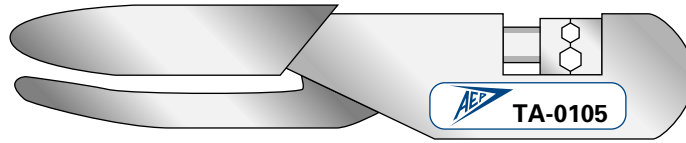

DESCRIPTION	AEP P/N
Crimp tool with .105" and .128" hex dies	TA-0105

## Torque Wrench



DESCRIPTION	AEP P/N
Torque wrench with 5/32" jaws for SSMC plug coupling nuts and straight connector backnuts; 30 inch-ounces torque	TA-0432

## Capping Tool

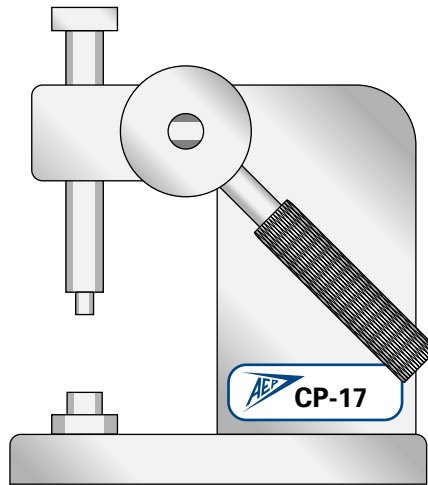

DESCRIPTION	AEP P/N
Capping tool (arbor press) with bases for SSMB/SSMC/SSLB right angle cable plugs and jacks	CP-17

Cable assembly instructions are shipped with each cable connector.



APPLIED ENGINEERING PRODUCTS

(203) 776-2813 • FAX (203) 776-8294 [www.aep.us](http://www.aep.us) • [aepsales@aep.us](mailto:aepsales@aep.us)

# Index by Part Number

(Click on any line to jump to the page)

P/N	Page	P/N	Page	P/N	Page
5011-1503-000	14	7141-1521-0XX*	21	7302-1572-0XX*	15
5013-1503-000	27	7141-1561-0XX*	21	7303-1541-0XX*	16
5937-1503-000	14	7145-1521-0XX	28	7303-1571-0XX*	16
5938-1503-000	27	7145-1521-1XX	28	7304-1511-000	17
7002-1542-0XX*	20	7145-1521-2XX	28	7305-1521-0XX*	15
7002-1572-0XX*	20	7145-1521-3XX	28	7305-1561-0XX*	15
7003-1542-0XX*	21	7145-1521-4XX	28	7309-1511-000	18
7003-1572-0XX*	21	7145-1521-5XX	28	7309-1511-012	18
7004-1512-000	22	7145-1521-6XX	28	7309-1511-015	18
7009-1511-000	23	7146-1521-0XX	28	7309-1511-040	18
7009-1511-004	23	7146-1521-1XX	28	7309-1511-050	18
7009-1511-005	23	7146-1521-2XX	28	7309-1511-060	18
7009-1511-040	23	7146-1521-3XX	28	7309-1511-061	18
7009-1511-041	23	7146-1521-4XX	28	7310-1511-000	18
7009-1511-050	23	7146-1521-5XX	28	7310-1511-012	18
7009-1511-061	23	7198-1513-000	27	7310-1511-015	18
7010-1511-000	23	7201-1541-0XX*	7	7310-1511-040	18
7010-1511-015	23	7201-1571-0XX*	7	7310-1511-050	18
7010-1511-040	23	7202-1542-0XX*	7	7310-1511-060	18
7010-1511-041	23	7202-1572-0XX*	7	7310-1511-061	18
7010-1511-050	23	7203-1541-0XX*	8	7312-1511-000	17
7010-1511-060	23	7203-1571-0XX*	8	7317-1512-000	17
7010-1511-061	23	7204-1511-000	9	7325-1512-000	19
7012-1511-000	22	7209-1511-000	10	7325-1512-012	19
7017-1512-000	22	7209-1511-011	10	7325-1512-015	19
7022-1502-000	14, 25	7209-1511-012	10	7325-1512-040	19
7025-1512-000	26	7209-1511-015	10	7325-1512-050	19
7025-1512-012	26	7209-1511-023	10	7325-1512-060	19
7025-1512-015	26	7209-1511-040	10	7325-1512-061	19
7025-1512-040	26	7209-1511-061	10	7332-1572-0XX*	16
7025-1512-050	26	7210-1511-000	10	7332-1572-3XX*	16
7025-1512-060	26	7210-1511-012	10	7335-1521-0XX*	16
7025-1512-061	26	7210-1511-015	10	7335-1521-3XX*	16
7029-1511-000	24	7210-1511-040	10	7340-1511-000	17
7029-1511-012	24	7210-1511-050	10	7341-1521-0XX*	15
7029-1511-015	24	7210-1511-060	10	7341-1561-0XX*	15
7029-1511-040	24	7210-1511-061	10	7342-1511-000	19
7029-1511-050	24	7212-1511-000	9	7342-1511-012	19
7029-1511-060	24	7217-1512-000	9	7342-1511-015	19
7029-1511-061	24	7219-1511-000	9	7342-1511-040	19
7040-1511-000	22	7222-1501-000	14	7342-1511-050	19
7042-1511-000	26	7225-1512-000	13	7342-1511-060	19
7042-1511-012	26	7225-1512-012	13	7342-1511-061	19
7042-1511-015	26	7225-1512-015	13	7396-1512-000	17
7042-1511-040	26	7225-1512-040	13	7405-1521-0XX*	7
7042-1511-050	26	7225-1512-050	13	7405-1561-0XX*	7
7042-1511-060	26	7225-1512-060	13	7406-1521-0XX*	8
7042-1511-061	26	7225-1512-061	13	7406-1561-0XX*	8
7100-1513-000	27	7229-1511-000	11	7410-1511-000	12
7101-1541-0XX*	20	7229-1511-012	11	7410-1511-012	12
7101-1571-0XX*	20	7229-1511-015	11	7410-1511-015	12
7105-1521-0XX*	20	7229-1511-040	11	7410-1511-040	12
7105-1561-0XX*	20	7229-1511-050	11	7410-1511-050	12
7106-1521-0XX*	21	7229-1511-060	11	7410-1511-060	12
7106-1561-0XX*	21	7229-1511-061	11	7410-1511-061	12
7110-1511-000	25	7240-1511-000	9	7441-1521-0XX*	8
7110-1511-012	25	7242-1511-000	13	7441-1561-0XX*	8
7110-1511-015	25	7242-1511-012	13	7496-1512-000	9
7110-1511-040	25	7242-1511-015	13	7498-1513-000	14
7110-1511-050	25	7242-1511-040	13	7499-1513-000	14
7110-1511-060	25	7242-1511-050	13	CP-17	29
7110-1511-061	25	7242-1511-060	13	TA-0105	29
7119-1512-000	22	7242-1511-061	13	TA-0432	29
7122-1502-000	27	7302-1542-0XX*	15		

\* Indicates cable connectors with various types on specified page.



## About AEP

Since our foundation in 1973, our goal has been to tailor our equipment and processes toward satisfying customer and market demand, no matter how circumstances change. To that end, our modern plant, with recent expansion, provides vertically-integrated machining, assembly, and testing to ensure the product quality and on-time delivery that have always been our hallmark.

"Continuous Improvement Equals Customer Satisfaction" is not just a slogan; we believe it's the best and only way to do business.



## Other AEP Products

The connectors in this brochure are only part of our complete line of coaxial connectors and cable assemblies, including:

- SMA • SMB • SMC • SMP • SSMA • SLB (Slide-on version of SMB) • MCX • MMCX • 75Ω Miniature SMB
- 75Ω Snap-on mating • 75Ω Screw-on mating • Adapters within and between series • Waterproof connectors
- Flexible cable assemblies • Semi-rigid cable assemblies
- And over 100 styles of MIL-PRF-39012 QPL connectors in series SMA, SMB, and SMC.



## APPLIED ENGINEERING PRODUCTS

104 John W. Murphy Drive • P.O. Box 510 • New Haven, CT 06513

(203) 776-2813 • FAX (203) 776-8294 • [www.aep.us](http://www.aep.us) • e-mail: [aepsales@aep.us](mailto:aepsales@aep.us)

31



# Mouser Electronics

Authorized Distributor

Click to View Pricing, Inventory, Delivery & Lifecycle Information:

Radial:

[7242-1511-050](#)