



N/TNC/TNC SELF-LOCK/C

R161/R162/R143/R144/R166

Section 12 Table of Contents

TYPE N

Introduction.....	12-2 to 12-3
Panel Drilling	12-21

N 50Ω AND COMPOSITE N

Interface.....	12-4
Characteristics	12-6 to 12-7
Plugs	12-9 to 12-11
Jacks	12-11 to 12-14
Receptacles.....	12-14 to 12-17
Composite N Receptacle	12-16
Adapters.....	12-17
Caps	12-18
Assessories	12-18

N 75Ω

Interface.....	12-5
Characteristics	12-8
Plugs	12-19
Jacks.....	12-19
Receptacles.....	12-20
Adapters.....	12-20

TNC

Introduction.....	12-22
Interface.....	12-23
Characteristics	12-24 to 12-25
Plugs	12-34
Jacks.....	12-34
Panel Drilling	12-35

TNC SELF-LOCK

Introduction.....	12-26
Plugs	12-27

TNC 50Ω

Plugs	12-28 to 12-29
Jacks.....	12-29 to 12-31
Receptacles.....	12-31 to 12-32
Caps	12-32
Adapters.....	12-33

C CONNECTORS

Introduction.....	12-36
Interface.....	12-36
Characteristics	12-37
Plugs & Jacks.....	12-38
Receptacles.....	12-39
In Series Adapters.....	12-39
Panel Drilling	12-39

N

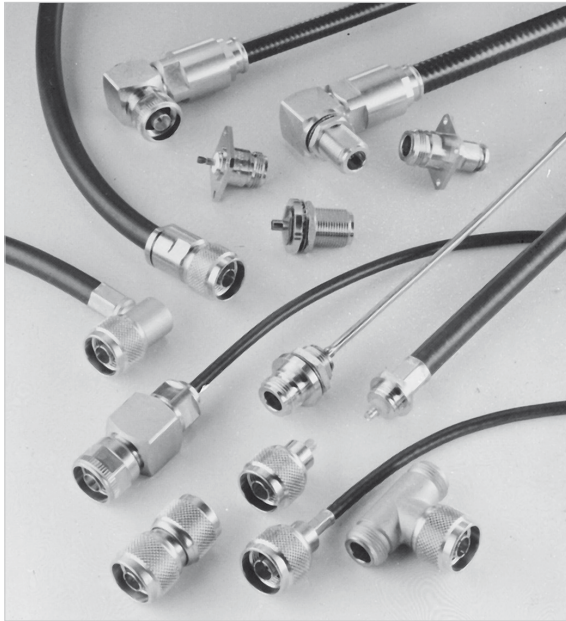

50Ω

DC - 11 GHz (standard N)
DC - 18 GHz (N 18 GHz)

INTRODUCTION

GENERAL

- Standard coaxial connectors
- Screw-on coupling
- High durability and proven strength
- High power rating
- Excellent RF performance

APPLICABLE STANDARDS

- MIL-C-39012 / MIL STD 348-304
- CEI 169-16
- CECC 22210
- NF-C-93566
- DS 8811

APPLICATIONS

- Wireless communications
- Civil and military radio-telecommunication equipment
- Countermeasure
- Navy equipment
- Industrial applications

COMPOSITE & SWITCHING CONNECTORS

FULL CRIMP MODELS

This reliable attachment system can be easily installed in a field environment, with easy-to-use tooling (including models for 2 and 2.6 mm dia cables). All our full crimp connectors are single piece body.

18 GHZ PRECISION CONNECTORS

These connectors are suitable for medium to high power applications and precision microwave test equipment. They have long life duration and enhanced electrical performance in severe environmental conditions. N18 series mate with all 50 ohms N connectors.

LOW INTERMODULATION CONNECTORS

Radiall's extensive knowledge in this field led to the development of N series connectors that are specially designed for base stations of applications where the elimination of intermodulation products is of the utmost importance.

Features:

- Optimized for 900 - 1800 MHz bands (and able to work up to 11 GHz like the standard models)
- IMP_3 performance = -110 dBm (-153 dBc)
- New models for corrugated and low loss flexible cables
- High performance non magnetic materials and platings (silver and BBR)
- New 6 flats coupling nut (18 mm), allowing high coupling torque (170 Ncm) thanks to torque wrench
- Non slotted outer contact

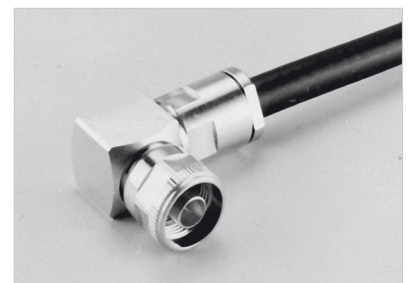
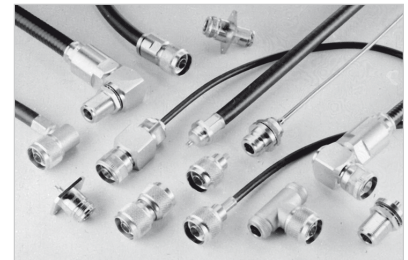

N

Radiall offers a wide range with a standard plating finish: BBR (Bright Bronze Radiall) a high performance non-magnetic alloy.

VERY LOW INTERMODULATION CABLE ASSEMBLIES

For severe intermodulation conditions, we propose a range of low intermodulation cable assemblies $IMP_3 \leq 125$ dBm.

For further details, reference:

- Intermodulation application guide (D1 032 DE)
- BBR plating application guide (D1 030 DE)

IMPORTANT: The 50Ω and the 75Ω connectors are NOT INTERMATEABLE and results in the destruction of the interface.

FEATURES & BENEFITS

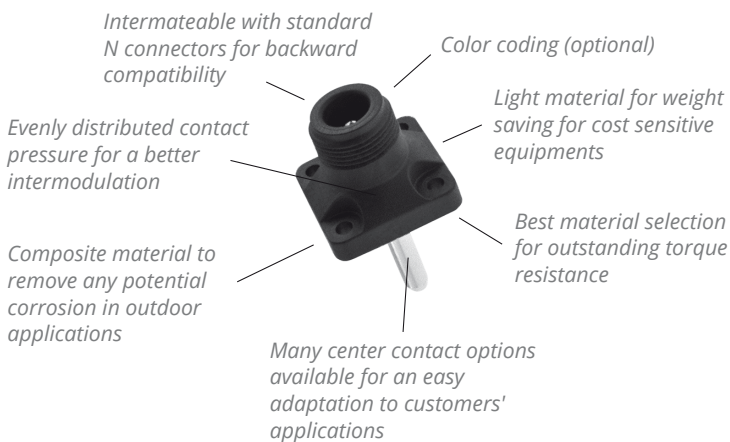

POWER SWITCHING CONNECTORS

This "two-in-one" solution replaces the existing standard RF switches by integrating the switch function into a receptacle connector. This solution provides a unique means of switching between two Rf signal paths. As user friendly as a standard connector, the switch is mechanically activated by mating and unmating the connector.

ADVANTAGES

- Reliable
- Increases the density
- Excellent electrical and mechanical performance
- Reduction of the cost of ownership
- Betty RF adaptation
- Good isolation
- Available in right or left versions

PLATING

Radiall offers a wide range with a standard plating finish: BBR (Bright Bronze Radiall) a high performance non-magnetic alloy.

COMPOSITE RECEPTACLES

Radiall introduces its new composite N receptacles. Composite N connectors offer outstanding electrical performance and are the best compromise in terms of weight, cost and mechanical characteristics to replace existing brass technology.

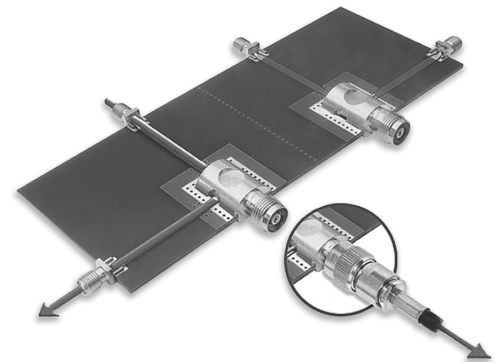

APPLICATIONS

- Telecom applications
- RF power amplifiers

N 50Ω

INTERFACE N 50Ω

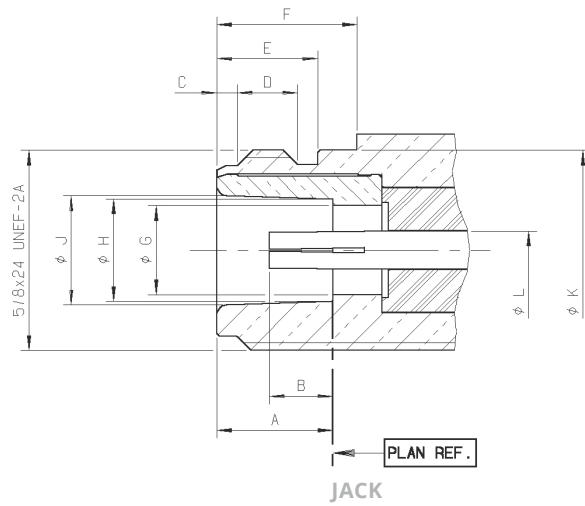
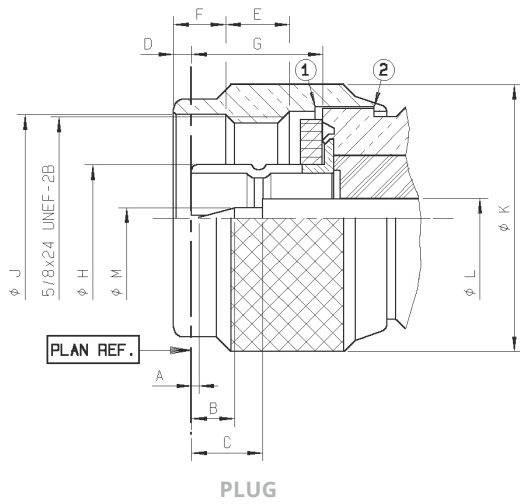

LETTER	MM		INCH	
	MIN	MAX	MIN	MAX
A	0.13	1.03	.005	.13
B	2.80	3.56	.110	.140
C	5.33	5.83	.210	.229
D	1	2	.016	.066
E	4.54	5.39	.179	.212
F	4.05	4.20	.159	.165
G	10.23	10.43	.403	.411
H DIA	8.27	8.37	.326	.329
J DIA	16.1	16.2	.634	.638
K DIA	20.9	21	.823	.827
L DIA	3.01	3.05	.118	.120
M DIA	1.63	1.67	.064	.066

LETTER	MM		INCH	
	MIN	MAX	MIN	MAX
A	9.05	9.19	.356	.362
B	4.75	5.25	.187	.207
C	1.20	1.95	.047	.077
D	4.4	5.1	.173	.201
E	6.8	9	.268	.354
F	10.9	11.2	.429	.441
G DIA	6.98	7.02	.275	.276
H DIA	8.03	8.13	.316	.320
J DIA	8.53	8.73	.336	.344
K DIA	15.65	15.85	.616	.624
L DIA	3.01	3.05	.118	.120

N 75Ω

INTERFACE N 75Ω

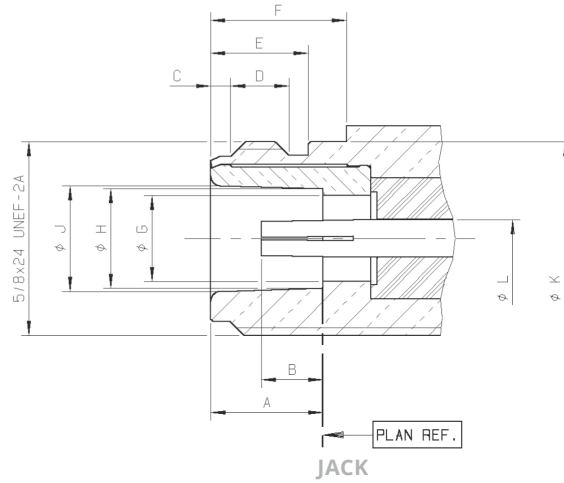
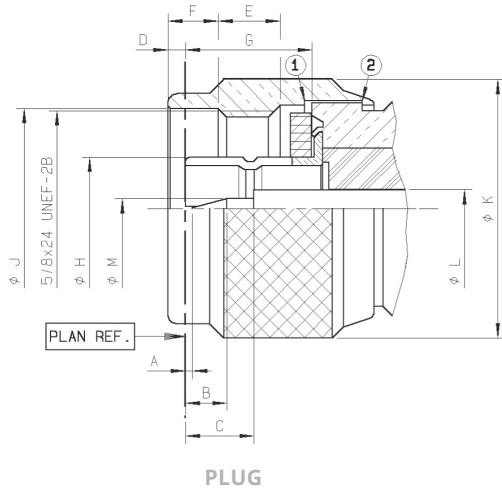

LETTER	MM		INCH	
	MIN	MAX	MIN	MAX
A	0.13	1.03	.005	.13
B	2.80	3.56	.110	.140
C	5.33	5.83	.210	.230
D	1	2	.016	.066
E	4.54	5.39	.179	.212
F	4.05	4.20	.159	.165
G	10.23	10.43	.403	.411
H DIA	8.27	8.37	.326	.329
J DIA	16.1	16.2	.634	.638
K DIA	20.9	21	.823	.827
L DIA	1.96	2	.077	.079
M DIA	0.87	0.91	.034	.036

LETTER	MM		INCH	
	MIN	MAX	MIN	MAX
A	9.05	9.19	.356	.362
B	4.75	5.25	.187	.207
C	1.20	1.95	.047	.077
D	4.4	5.1	.173	.201
E	6.8	9	.268	.354
F	10.9	11.2	.429	.441
G DIA	6.98	7.02	.275	.276
H DIA	8.03	8.13	.316	.320
J DIA	8.53	8.73	.336	.344
K DIA	15.65	15.85	.616	.624
L DIA	1.96	2	.077	.079

IMPORTANT: the 50Ω and the 75Ω connectors are NOT INTERMATEABLE, results in the interface destruction.

Notes

Statistics dimensions: .0539 .0055 (.0594 max)/(1.37 0.14)(1.51 max)

1) Coupling nut against on datum 1

2) Coupling nut against on datum 2

N 50Ω

CHARACTERISTICS

TEST / CHARACTERISTICS	STANDARD REFERENCE	VALUES / REMARKS
------------------------	--------------------	------------------

ELECTRICAL CHARACTERISTICS

Impedance	-	50Ω				
Frequency Range	-	DC - 11 GHz				
Typical V.S.W.R. • Straight Models Cable Group:	Frequency	-	1 GHz	2.5 GHz	5 GHz	11 GHz
	.085"	-	1.03	1.03	1.05	1.08
	.141"	-	1.03	1.05	1.05	1.08
	.250"	-	1.03	1.03	1.05	1.07
	5/S+5/D	-	1.05	1.06	1.1	1.16
	10/S+11/D	-	1.04	1.05	1.09	1.2
	5/S+D	-	1.04	1.05	1.18	
10/S+11/D	-	1.04	1.1	1.20		
Intermodulation product (IMP₃) • Standard Connectors • Intermodulation Connectors • Home Made Intermodulation Cable Assemblies	-	- 90 dBm typ. (- 133 dBc typ. / 20W)				
	-	- 110 dBm typ. (- 153 dBc typ. / 20W)				
	-	- 125 dBm typ. (- 165 dBc typ. / 20W)				
Insertion Loss • Straight Connector • Right-Angle Connector	MIL	< 0.15 dB max at 10 GHz ~ < 0.05 √F (GHz) < 0.15 dB max at 10 GHz ~ < 0.1 √F (GHz)				
	MIL	-90 dB min from 2 to 3 GHz (Interface)				
RF Leakage	MIL	5000 MΩ min				
Insulation Resistance	MIL	5000 MΩ min				
Contact Resistance • Center Contact • Outer Contact	MIL	Initial	After Tests			
		1 mΩ	1.5 mΩ			
		0.2 mΩ	-			
Working Voltage in VRMS • At Sea Level (at 70,000 feet)	CECC	Cable 5/50:	850	(250)		
		Cable .085"/.141":	350	(250)		
		Cable 10+11/50:	1400	(400)		
		Cable LMR 400/600:	1400	(400)		
		Cable .250":	1400	(400)		
Dielectric Withstanding Voltage in VRMS • At Sea Level (at 70,000 feet)	CECC	Cable 5/50:	1500	(350)		
		Cable .085"/.141":	1000	(350)		
		Cable 10/50:	2500	(600)		
		Cable LMR 400/600:	2500	(600)		
		Cable .250":	2500	(600)		
RF Testing Voltage	Sea Level	CECC	1500 VRMS (5 MHz Sine Wave)			

MECHANICAL CHARACTERISTICS

Durability	CECC	500 Matings			
Engagement and Separation Torque	CECC	6.6 Ncm max (.58 Inch-pounds)			
Recommended Coupling Nut Torque	-	40 to 60 Ncm (Manual)			
		130 Ncm (11.45 inch pounds) (with Pliers R 282 202 000)			
		170 Ncm (14.96 inch pounds) (with Torque Wrench R 282 303 020)			
Proof Torque	CECC	170 Ncm (14.96 inch pounds)			
Coupling Nut Retention Force	CECC	450 N (101.25 Lbs)			
Cable Retention Force	CECC	Cable 5/50/S	150N	(33.75 Lbs)	
		Cable 5/50/D	200N	(48 Lbs)	
		Cable 10/50	300N	(67.5 Lbs)	
		Cable 11/50	400N	(90 Lbs)	
		Cable .141"	270N	(60.75 Lbs)	
Center Contact Retention Force	Axial	MIL	27 N (6.08 Lbs) Cables < Ø 8 mm		
			68 N (15.30 Lbs) Cables > Ø 8 mm		

Notes

Standard packaging = 50 pieces

N 50Ω

CHARACTERISTICS

TEST / CHARACTERISTICS	STANDARD REFERENCE	VALUES / REMARKS
------------------------	--------------------	------------------

ENVIRONMENTAL CHARACTERISTICS

Temperature Range • Standard Models • Semi-Rigid Cables	CECC	- 55 °C + 155 °C - 55 °C + 105 °C
Thermo Cycling Test	CECC	- 55 °C/+ 155 °C/21 j
Thermal Shock	CECC	- 40 °C/+ 155 °C or - 40 °C/+ 85 °C – 5 Cycles
High Temperature Test	CECC	125 °C/1000 H
Corrosion Salt Spray	CECC	48 H
Vibration	CECC	Sinus 10g/10 – 500 Hz
Shock	CECC	1/2 Sinus 50g/11 ms
Moisture Resistance • Clamp Type • Crimp Type	IEC 529	IP 67 IP 65 (with Heatshrink Sleeve)
Hermetic Test	CECC	10 ⁻⁵ bar. cm ³ /s
Leakage	CECC	Differential Pressure 100 to 110 KPa: 1 bar cm ³ / H

MATERIALS

Body / Nut / Center Male Contact / Outer Contact	Brass
Center Female Contact	Treated Beryllium Copper
Ferrule	Brass
Insulator	PTFE
Gasket	Silicone Elastomer

PLATING

	Standard	Intermodulation Models + COAXI-KIT
Body • Crimp + Clamp Type • Solder Type	BBR Gold	Silver + BBR Silver
Coupling Nut / Design	BBR / Cross Knurled	BBR / Hex.
Center Contacts	Gold	Silver
Outer Contacts / Design	BBR / Slotted	Silver + BBR / Non Slotted

PACKAGING

Packaging	50 Pieces Bulk Unit Packaging
-----------	----------------------------------

Notes

Some connectors may feature different performances depending on the application they have been designed for, or according to the applicable cable.

N 75Ω

CHARACTERISTICS

TEST / CHARACTERISTICS	STANDARD REFERENCE	VALUES / REMARKS
------------------------	--------------------	------------------

ELECTRICAL CHARACTERISTICS

Impedance	-	75Ω
Frequency Range	-	DC - 1.5 GHz
Typical V.S.W.R. • Cable 6/75 • Cable 10+11/75	- -	1.06 1.10
Insertion Loss • Straight Connector • Right-Angle Connector	MIL	< 0.15 dB
RF Leakage	MIL	- 90 dB min at 1 GHz
Insulation Resistance	MIL	5000 MΩ min
Contact Resistance • Center Contact • Outer Contact	MIL	Initial 1 mΩ 0.2 mΩ After Tests 1.5 mΩ -
Working Voltage in VRMS At Sea Level (At 70,000 feet)	CECC	Cable 10+11/75: 1400 (400) Cable 6/75: 850 (250)
Dielectric Withstanding Voltage in VRMS At Sea Level (At 70,000 feet)	CECC	Cable 10+11/75: 2500 (600) Cable 6/75: 1500 (350)
RF Testing Voltage Sea Level	CECC	1500 VRMS (5 MHz Sine Wave)

MECHANICAL CHARACTERISTICS

Durability	CECC	500 Matings
Engagement and Separation Torque	CECC	6.6 Ncm max (.58 Inch-pounds)
Recommended Coupling Nut Torque	CECC	40 to 60 Ncm (Manual) 130 Ncm (11.45 inch pounds) (with Pliers R282 202 000)
Proof Torque	CECC	170 Ncm (14.96 inch pounds)
Coupling Nut Retention Force	CECC	450 N (101.25 Lbs)
Cable Retention Force • Cable 6/75 • Cable 10+11/75	CECC	200 N 300 N
Center Contact Retention Force Axial	MIL	27 N (6.08 Lbs)

ENVIRONMENTAL CHARACTERISTICS

Temperature Range	CECC	- 55 °C + 155 °C
Thermo Cycling Test	CECC	- 55 °C / + 155 °C / 21 j
Thermal Shock	CECC	- 40 °C / + 155 °C or - 40 °C / + 85 °C - 5 Cycles
High Temperature Test	CECC	125 °C/1000 H
Corrosion Salt Spray	CECC	48 H
Vibration	CECC	Sinus 10g/10 - 500 Hz
Shock	CECC	1/2 Sinus 50g/11 ms
Moisture Resistance • Clamp Type • Crimp Type	IEC 529	IP 67 IP 65 (with Heatshrink Sleeve)
Hermetic Test	CECC	10 ⁻⁵ bar. cm ³ /s
Leakage	CECC	Differential Pressure 100 to 110 KPa: 1 bar cm ³ / H

MATERIALS

Body (Nut) / Center Male Contact / Outer Contact)	Brass
Center Female Contact	Treated Beryllium Copper
Ferrule	Brass
Insulator	PTFE
Gasket	Silicone Elastomer

PLATING

Body	BBR
Coupling Nut / Design	BBR / Cross Knurled
Center Contacts	Gold
Outer Contacts / Design	BBR / Slotted

Notes

Standard packaging = 50 pieces

N 50Ω

PLUGS

STRAIGHT PLUGS, FULL CLAMP AND CRIMP TYPE, FOR FLEXIBLE CABLES (SINGLE PIECE BODY)

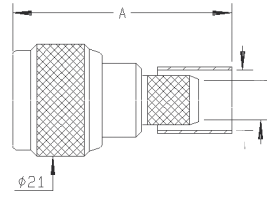
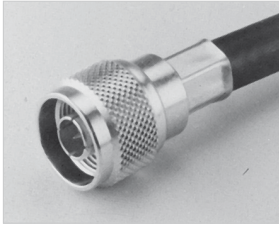

FIG. 1

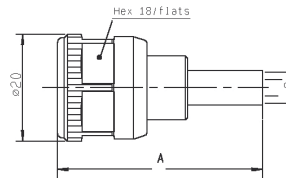

FIG. 2

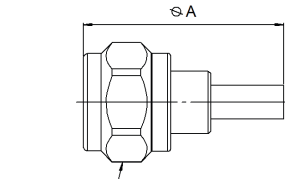

FIG. 3

CABLE GROUP	CABLE GROUP DIA.	PART NUMBER	FIG.	DIMENSIONS (MM)			CAPTIVE CENTER CONTACT	NOTE
				A				
RG174 / RG316 / RD316 / AEP-100FR	2.6/50/S+D & LMR® 100	R161 072 000	1	39.7	Yes		-	
RG58 / R141	5/50/S	R161 082 000		38.5			-	
RG142 / RG223 / RG400	5/50/D	R161 083 000	2	38.5			For Intermodulation Application Tool	
		R161 083 137		40.2			-	
RG213	10/50/S	R161 075 000	1	37.2	No		-	
-	10.3/50/S	R161A 075 000		40.2	Yes		LMR 400 Cable	
RG214	11/50/D	R161 088 000	2	40.2			-	
		R161 088 137		40.2			For Intermodulation Application Tool	
AEP-195FR	LMR® 195	R161 082 120	3	38.5	Yes		Crimp Type	
AEP-200FR	LMR® 200	R161 082 200	1	38.5				
AEP-240FR	LMR® 240	R161 075 030	3	38.5				
AEP-400FR	LMR® 400	R161 088 180		40.1				
RD316	2.6/50/D	4000-7071-019	1	40.41	No		Crimp Type for Flexible Cable	

STRAIGHT PLUGS, CLAMP TYPE, FOR FLEXIBLE CABLES

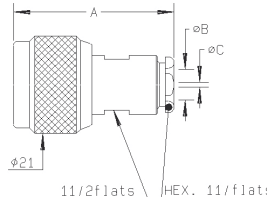
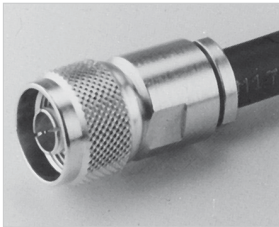

FIG. 1

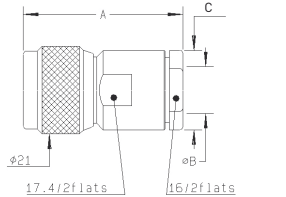

FIG. 2

CABLE GROUP	CABLE GROUP DIA.	PART NUMBER	FIG.	DIMENSIONS (MM)			CAPTIVE CENTER CONTACT
				A	B DIA	C DIA	
RG174 / RG316 / RD316	2.6/50/S+D	R161 004 000	1	33.9	3.1	1.7	Yes
RG58 / RG141 / RG142 / RG223 / RG400	5/50/S+D	R161 006 000		34.4	5.6	-	No
		R161 010 000		34.9	5.6	-	Yes
RG59 / RG62 / RG71	6/75+93	R161 012 000		34.4	6.6	-	-
RG213 / RG393 / RG11 / RG12 / RG144 / RG214 / RG216	10+11/50+75	R161 018 000	2	44	11.2	17.5	-
		R161 020 000		38.1	11.2	17.5	No
		R161 022 000		38.9	11.2	19	Yes
RG217	14/50/D	R161 027 000		40.9	14.4	22.2	-

N 50Ω

STRAIGHT PLUGS, FOR SEMI-RIGID CABLES

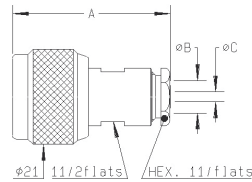
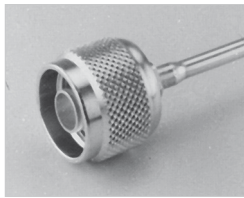

FIG. 1

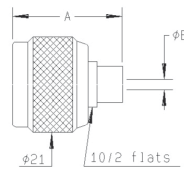

FIG. 2

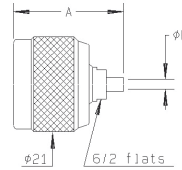

FIG. 3

CABLE GROUP	CABLE GROUP DIA.	PART NUMBER	FIG.	DIMENSIONS (MM)			CAPTIVE CENTER CONTACT	NOTE
				A	B DIA	C DIA		
RG405	.085"	R161 050 300	3	24.4	2.25	-	-	Solder Type
RG402	.141"	R161 051 000 R161 052 000			3.65	-		Solder Type
RG401	.250"	R161 053 000	1	35	5.6	3.65	No	Clamp Type
		R161 054 000	2	35.4	6.6	-		Solder Type

RIGHT ANGLE PLUGS, CRIMP TYPE, FOR FLEXIBLE CABLES

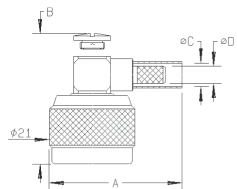
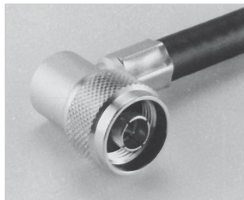

FIG. 1

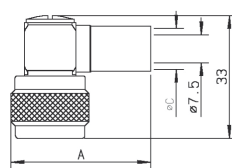

FIG. 2

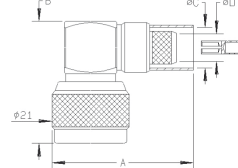

FIG. 3

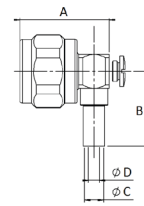

FIG. 4

CABLE GROUP	CABLE GROUP DIA.	PART NUMBER	FIG.	DIMENSIONS (MM)				CAPTIVE CENTER CONTACT	NOTE
				A	B	C DIA	D DIA		
RG174 / RG316	2.6/50/S	R161 181 000	1	29.5	26.3	-	-	-	-
RG58 / RG141	5/50/S	R161 182 000			28	5.41	-		-
RG142 / RG223 / RG400	5/50/D	R161 183 000 R161A 183 000			34.5	28	5.8		3.1
-	-	R161 185 000	3	42.4	33.2	11.05	7.46	Yes	ECO Version
-	-	R161 186 000	2	37.6	-	11.4	-		Full Crimp
RG214	11/50/D	R161 187 000	3	42.4	33.2	11.4	7.46		Full Crimp
AEP-200FR	LMR® 200	R161 182 080	4	26.3	22	5.55	3.25		Crimp Type
AEP-240FR	LMR® 240	R161 183 310			24	6.6	4.05		
AEP-400FR	LMR® 400	R161 184 080			27	33	11.05		
AEP-600FR	LMR® 600	R161 188 200			31.7	39.1	15.88	11.96	

RIGHT ANGLE PLUGS, CLAMP TYPE, FOR FLEXIBLE CABLES

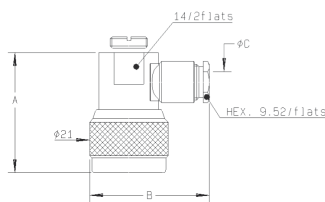

FIG. 1

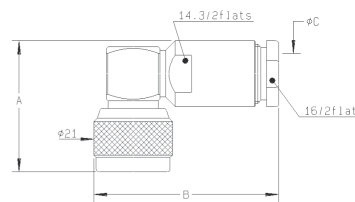

FIG. 2

CABLE GROUP	CABLE GROUP DIA.	PART NUMBER	FIG.	DIMENSIONS (MM)			CAPTIVE CENTER CONTACT
				A	B	C DIA	
RG223 / RG142 / RG223 / RG400	5/50/S+D	R161 157 000	1	32	32	5.6	Yes
RG213 / RG393 / RG214	10+11/50/S+D	R161 168 000	2	34.85	49.4	11.3	

N 50Ω

PLUGS & JACKS

RIGHT ANGLE PLUG, SOLDER TYPE, FOR SEMI-RIGID CABLES

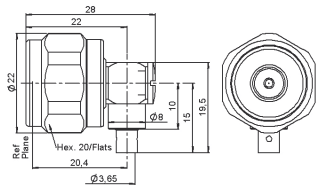

CABLE GROUP	CABLE GROUP DIA.	PART NUMBER	CAPTIVE CENTER CONTACT
RG402	.141"	R161 152 107	Yes

STRAIGHT JACKS, FULL CRIMP TYPE, FOR FLEXIBLE CABLES (SINGLE PIECE BODY)

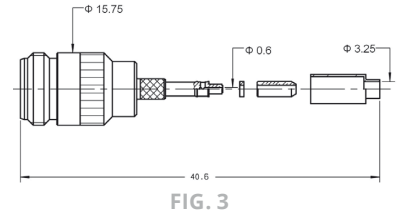
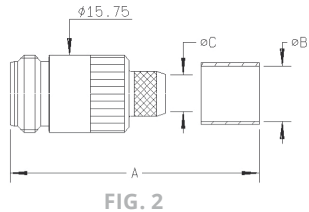
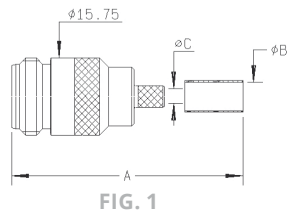

CABLE GROUP	CABLE GROUP DIA.	PART NUMBER	FIG.	DIMENSIONS (MM)			CAPTIVE CENTER CONTACT
				A	B DIA	C DIA	
RG58 / RG216 / RD316	2.6/50/S+D	R161 236 000	3	-	-	-	Yes
RG58 / RG141	5/50/S	R161 237 000	1	39.3	5.41	3.11	
RG142 / RG223 / RG400	5/50/D	R161 238 000			5.8		
RG223	10/50/S	R161 241 000	2	40.6	11.05	7.46	
RG214	11/50/D	R161 243 000			11.4		

STRAIGHT JACKS, CLAMP TYPE, FOR FLEXIBLE CABLES

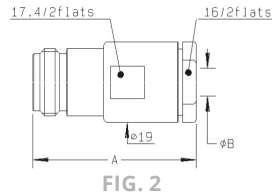
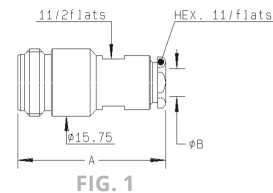

CABLE GROUP	CABLE GROUP DIA.	PART NUMBER	FIG.	DIMENSIONS (MM)		CAPTIVE CENTER CONTACT
				A	B DIA	
RG58 / RG142 / RG223 / RG400	5/50/S+D	R161 206 000	1	35.3	5.6	Yes
RG213 / RG393 / RG214	10+11/50/S+D	R161 220 000	2	39.3	11.2	

STRAIGHT JACKS

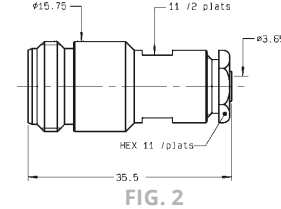
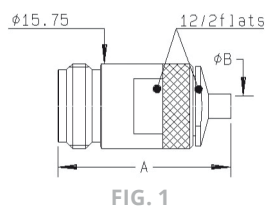

CABLE GROUP	CABLE GROUP DIA.	PART NUMBER	FIG.	DIMENSIONS (MM)		CAPTIVE CENTER CONTACT	NOTE
				A	B DIA		
RG402	.141"	R161 226 020	1	32	3.65	No	Solder Type
		R161 227 000	2	-	-	-	Clamp Type

N 50Ω

JACKS

SQUARE FLANGE, STRAIGHT JACKS, FULL CRIMP TYPE, FOR FLEXIBLE CABLES (SINGLE PIECE BODY)

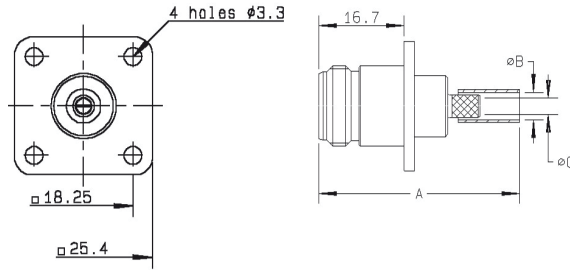
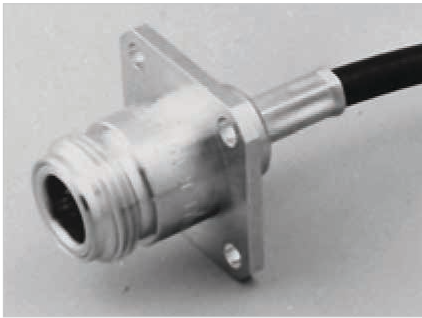

CABLE GROUP	CABLE GROUP DIA.	PART NUMBER	DIMENSIONS (MM)			CAPTIVE CENTER CONTACT	PANEL DRILLING
			A	B DIA	C DIA		
RG178	2/50/S+D	R161 281 000	40.3	2.35	1	-	P01
RG174 / RG316 / RD176	2.6/50/S+D	R161 281 300	40.3	3.25	1.63	-	
RG58 / RG141	5/50/S	R161 282 000	39.3	5.41	-	-	
RG142 / RG223 / RG400 / RG213	5/50/D	R161 283 000	39.3	5.8	3.11	-	
RG213	10/50/S	R161 286 000	40.6	11.05	7.46	Yes	

SQUARE FLANGE, STRAIGHT JACKS

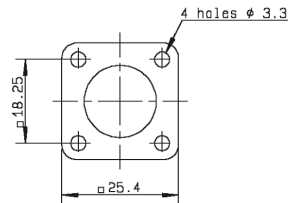
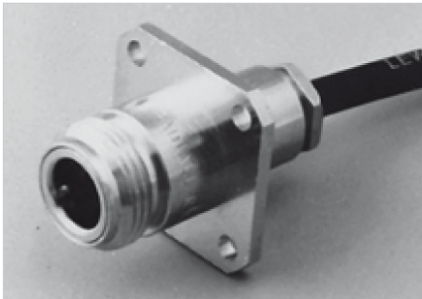

FIG. 1 & 2

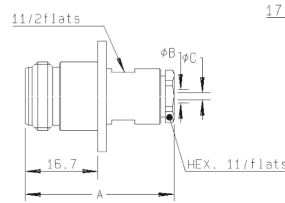

FIG. 1

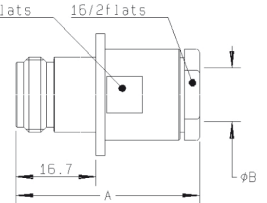

FIG. 2

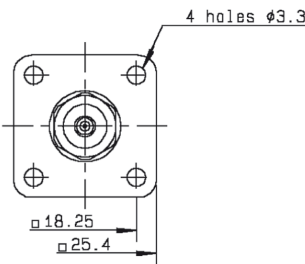
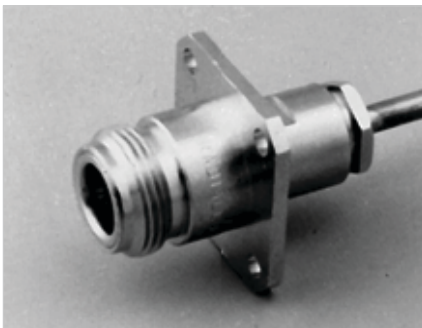

FIG. 3 & 4

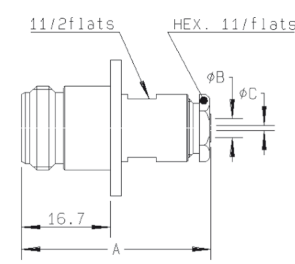

FIG. 3

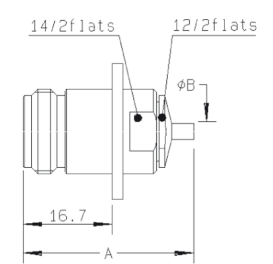

FIG. 4

CABLE GROUP	CABLE GROUP DIA.	PART NUMBER	FIG.	DIMENSIONS (MM)			CAPTIVE CENTER CONTACT	PANEL DRILLING	NOTE
				A	B DIA	C DIA			
RG174 / RG316 / RD316	2.6/50/S+D	R161 252 000	1	34.3	3.1	1.7	Yes	P01	Clamp Type
RG58 / RG141 / RG142 / RG223 / RG400	5/50/S+D	R161 256 000		35.4	5.6	-			
RG213 / RG393 / RG214	10 + 11/50/S + D	R161 270 000		2	39.3	11.2			
RG402	.141"	R161 277 000	3	35.5	5.6	3.65	No	P01	Solder Type Clamp Type
		R161 277 300	4	32	3.65	-			
RG401	.250"	R161 278 000	3	35.9	6.6	-			

N 50Ω

BULKHEAD JACKS

BULKHEAD STRAIGHT JACKS, FULL CRIMP TYPE, FOR FLEXIBLE CABLES (PANEL SEALED) (SINGLE PIECE BODY)

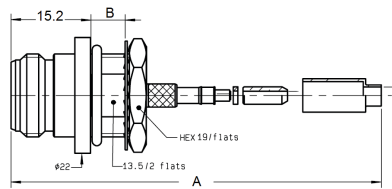

FIG. 1

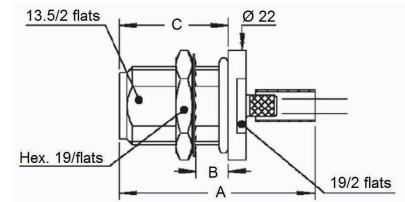

FIG. 2

CABLE GROUP	CABLE GROUP DIA.	PART NUMBER	FIG.	DIMENSIONS (MM)			CAPTIVE CENTER CONTACT	PANEL DRILLING	NOTE
				A	B	C			
RG174 / RG316 / RD316	2.6/50/S+D	R161 311 200	1	40.4		-			Front Mount
		R161 311 300							
RG58 / R141	5/50/S	R161 329 000	2	39.8	6.5	22.2	Yes	P11	Rear Mount
RG142 / RG223 / RG400	5/50/D	R161 329 200							
RG214	11/50/D	R161 331 200							
AEP-200FR	LMR® 200	R161 329 130							
AEP-240FR	LMR® 240	R161 329 140							
AEP-400FR	LMR® 400	R161 331 060							
AEP-600FR	LMR® 600	R161 331 400	49.9	23.7					

BULKHEAD STRAIGHT JACKS, CLAMP TYPE, FOR FLEXIBLE CABLES (PANEL SEALED)

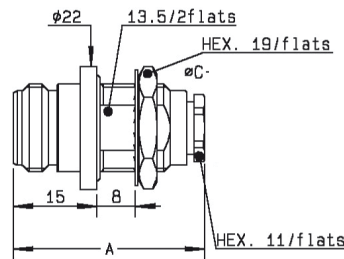

FIG. 1

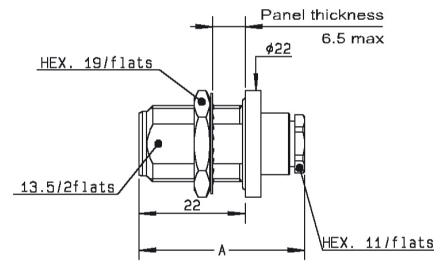

FIG. 2

CABLE GROUP	CABLE GROUP DIA.	PART NUMBER	FIG.	DIMENSIONS (MM)	CAPTIVE CENTER CONTACT	PANEL DRILLING	NOTE
				A			
RG174 / RG316 / RD316	2.6/50/S+D	R161 321 000	1	34.3	Yes	P11	Front Mount
		R161 322 000					
RG58 / RG141 / RG142 / RG223 / RG400	5/50/S+D	R161 325 000	2	35.4			Rear Mount
RG213 / RG393 / RG214	10+11/50/S+D	R161 332 000					
RG174 / RG316	2.6/50/S	4501-7051-003					
RG174 / RG316	2.6/50/S	4502-7051-003	1	26.7	No	-	Front Mount Hex. Nut 16mm Body Dia. 17.5mm

N 50Ω

BULKHEAD STRAIGHT JACKS, FOR SEMI-RIGID CABLES (PANEL SEALED)

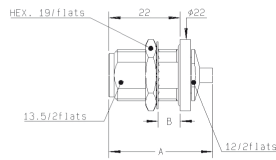
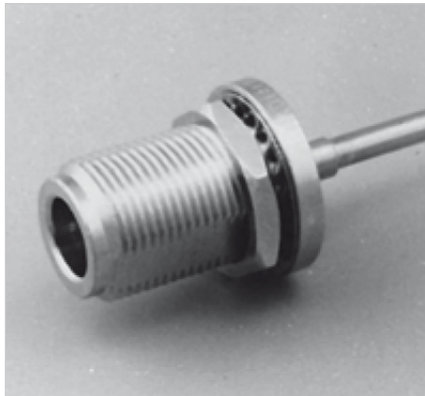

FIG. 1

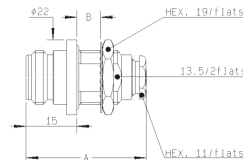

FIG. 2

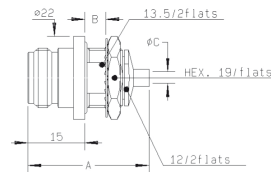

FIG. 3

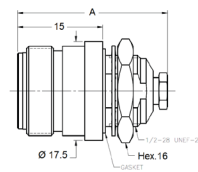
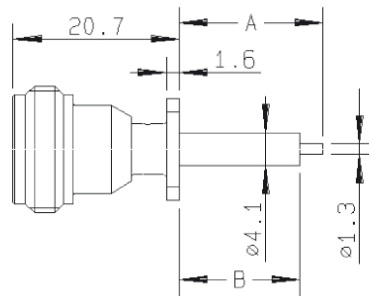
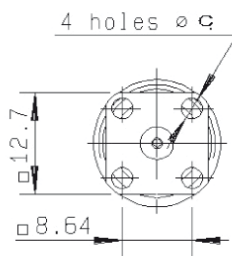

FIG. 4

CABLE GROUP	CABLE GROUP DIA.	PART NUMBER	FIG.	DIMENSIONS (MM)		CAPTIVE CENTER CONTACT	PANEL DRILLING	NOTE
				A	B			
RG405	.085"	R161 335 200	1	32	6.5	No	P11	Solder Type / Rear Mount
RG402	.141"	R161 323 000	2	35.5	8			Clamp Type / Front Mount
		R161 336 000	1	32	6.5			Solder Type / Rear Mount
		R161 336 200	3					Solder Type / Front Mount
RG401	.250"	R161 337 200	1					Solder Type / Rear Mount
RG405	.085"	4502-7041-010	4	26.56	-	-	Solder Clamp / Front Mount	
RG402	.141"	4502-7041-009	1	33.52	-		Yes	Solder Clamp / Rear Mount

RECEPTACLES

LOW PROFILE SQUARE FLANGE, STRAIGHT FEMALE RECEPTACLE



PART NUMBER	DIMENSIONS (MM)			CAPTIVE CENTER CONTACT	PANEL DRILLING	NOTE
	A	B	C DIA			
R161 410 520	17.9	15	2.9	Yes	P08	Extended Dielectric

N 50Ω

FLANGE, STRAIGHT FEMALE RECEPTACLES

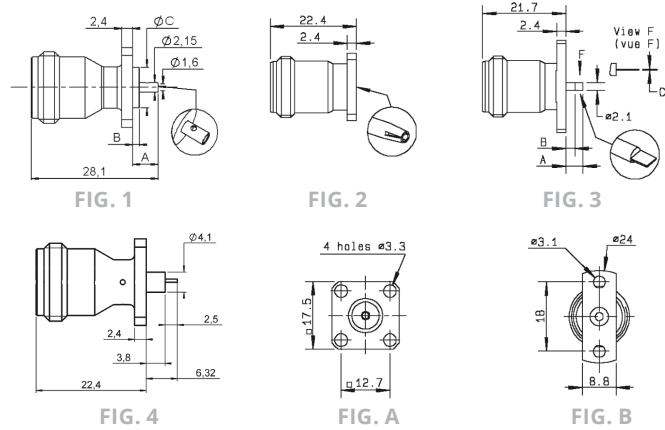
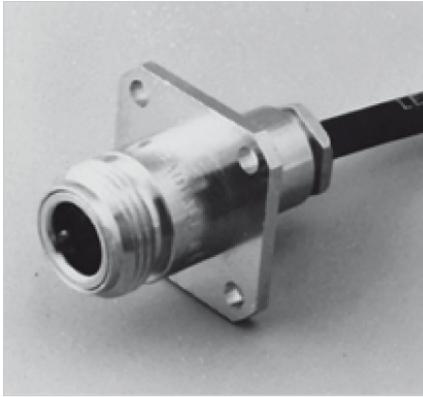

PART NUMBER	FIG.	DIMENSIONS (MM)			CAPTIVE CENTER CONTACT	PANEL DRILLING	NOTE
		A	B	C			
R161 410 000	1 + A	5.7	1.5	8.9	Yes	P03	-
R161A 410 000							ECO Version
R161 410 130	4 + A	-	-	-		P13	Solder Pot Contact
R161 418 000	2 + A	-	-	-		P03	Universal / See Contacts page 12-22
R161 461 000	3 + B	6.2	3.9	0.6		P09	2 Hole Flange / Flat Tab Contact

STRAIGHT MALE AND FEMALE RECEPTACLES

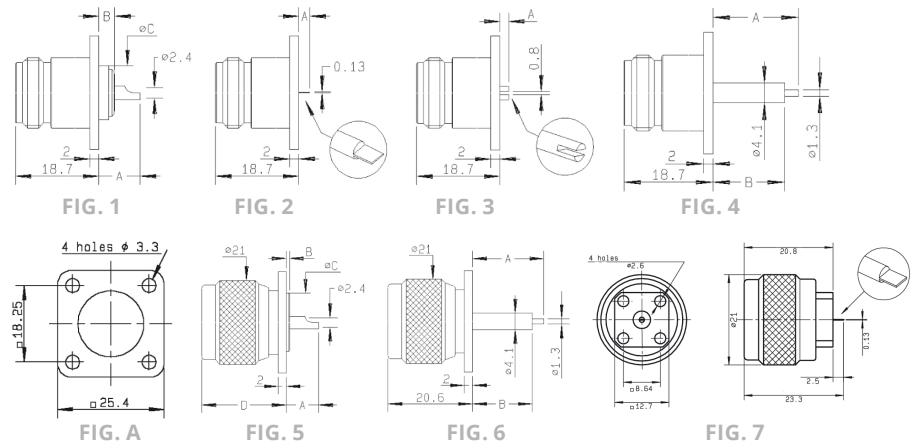

PART NUMBER	FIG.	DIMENSIONS (MM)				CAPTIVE CENTER CONTACT	PANEL DRILLING	NOTE
		A	B	C DIA	D			
R161 404 000	1 + A	9.3	0.8	14.6	-	Yes	P05	Solder Pot
R161A 404 000								Solder Pot / ECO Version
R161 404 137								For Intermodulation Application / Center Contact Brass
R161 416 130	4 + A	17.9	15	-	-		P06	Extended Dielectric
R161 419 020	2 + A	2.5	-	-	-		P07	Flat Tab Contact
R161 419 300	3 + A	2	-	-	-		P01	Slotted Contact
R161 441 000	5 + A	8.7	0.8	14.6	20.6		P02	Male / Solder Pot
R161 441 400	6 + A	17.9	15	-	-		P04	Male / Extended Dielectric
R161 438 200	7	-	-	-	-	P08	-	

N 50Ω - Composite N

COMPOSITE FEMALE RECEPTACLES ⁽¹⁾

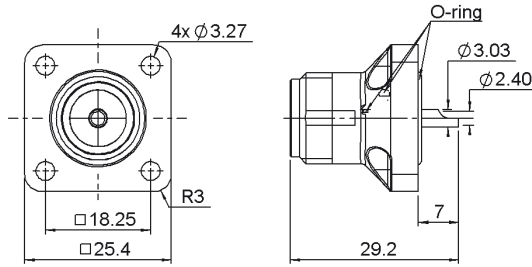
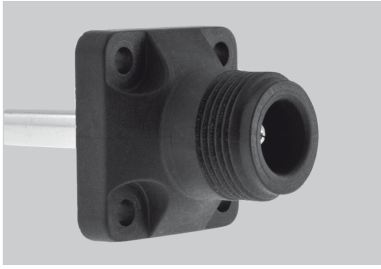

PART NUMBER	CAPTIVE CENTER CONTACT	DESCRIPTION	COLOR	PACKAGING
R161 404 C01	Yes	-	Black	50 Pieces
R161 404 C02		Combination Seal		
R161 404 C03		Panel Seal		

RIGHT ANGLE FEMALE RECEPTACLES

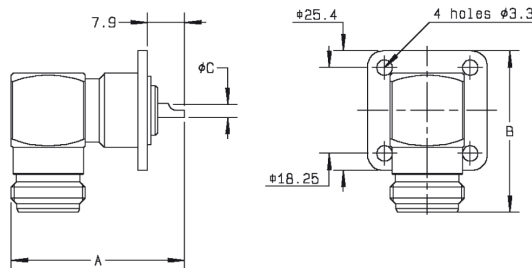
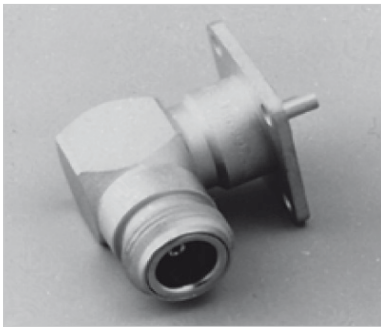

PART NUMBER	DIMENSIONS (MM)			CAPTIVE CENTER CONTACT	PANEL DRILLING	NOTE
	A	B	C DIA			
R161 653 000	36.9	34.4	2.5	Yes	P02	Solder Pot

BULKHEAD STRAIGHT RECEPTACLES (FULLY SEALED OR PANEL HERMETIC)

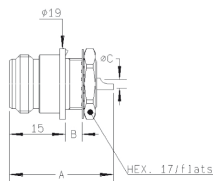

FIG. 1

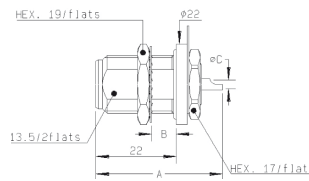

FIG. 2

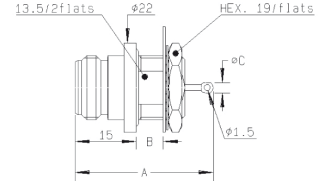

FIG. 3

PART NUMBER	FIG.	DIMENSIONS (MM)			CAPTIVE CENTER CONTACT	PANEL DRILLING	NOTE
		A	B	C			
R161 570 000	1	28	4.5	2.4	Yes	P10	Front Mount
R161 606 000	2	34.6	6.5	2.4		Rear Mount / Fully Sealed	
R161 625 000	3	34	6.5	2.5		Front Mount / Panel Hermetic	

Notes

1. Available upon request. Processed according to customer needs.

N 50Ω

N SMT SWITCH AND RECEPTACLE

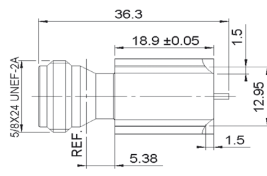

FIG. 1

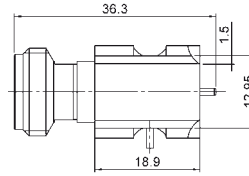

FIG. 2

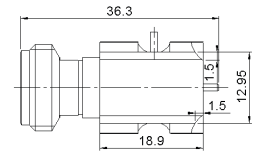

FIG. 3

PART NUMBER	FIG.	NOTE
R161 427 223	1	Edge Card Female Receptacle
R161 428 223	2	Edge Card SMT Left Type Switch
R161 428 233	3	Edge Card SMT Right Type Switch

**ADAPTERS
IN SERIES ADAPTERS**

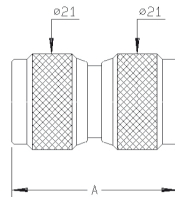
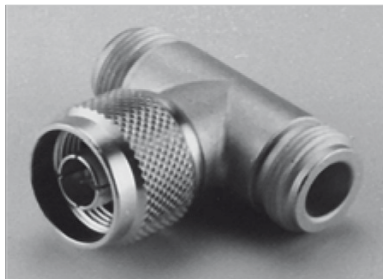

FIG. 1

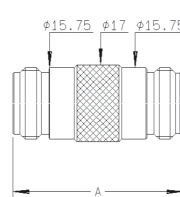

FIG. 2

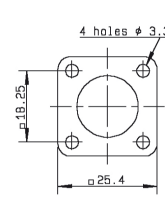

FIG. 3

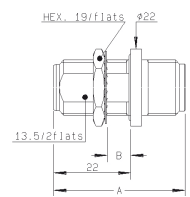
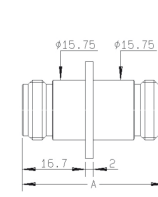

FIG. 4

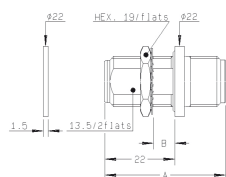

FIG. 5

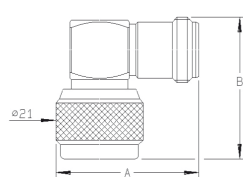

FIG. 6

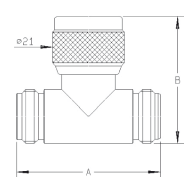

FIG. 7

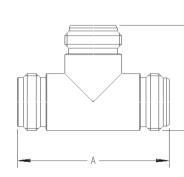

FIG. 8

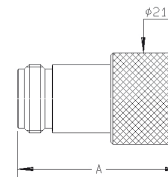

FIG. 9

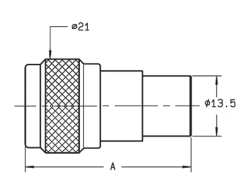
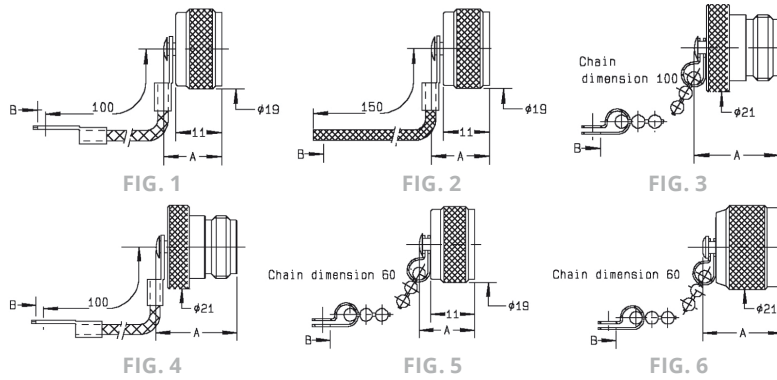
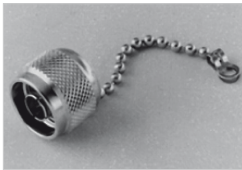

FIG. 10

PART NUMBER	FIG.	DIMENSIONS (MM)		PANEL DRILLING	NOTE
		A	B		
R161 703 000	1	36.7	-	-	Male - Male
R161 705 000	2	-	-	-	Female - Female
R161 715 000	3	37.5	-	P01	Female - Female / Flange
R161 730 000	4	-	6.5	P11	Female - Female / Bulkhead Panel Sealed
R161 753 000	5	38	6.5	P11	Female - Female / Hermetic / Bulkhead
R161 771 000	6	34.4	34	-	Male - Female / Right Angle
R161 780 000	7	42	36.9	-	Tee Female - Female / Male
R161 782 000	8	42	29.1	-	Tee Female - Female / Female
R161 791 500	9	37.37	-	-	Push-On Male / Female Screwing
R161 791 530	10	37.2	-	-	Push-On Female / Male Screwing

N 50Ω

CAPS & ACCESSORIES
PROTECTIVE CAPS



PART NUMBER	FIG.	DIMENSIONS (MM)		NOTE
		A	B	
R161 804 000	1	13.9	3.8	Male with Cord
R161 805 410	2	13.9	2	Male with Cord
R161 841 000	3	20.4	3.9	Female with Chain
R161 844 000	4	20.4	3.8	Female with Cord
R161 853 000	5	13.9	3.9	Male with Chain
R161 862 000	6	20.1		Male Short Circuit with Chain

FIELD-REPLACEABLE CONTACTS (FOR UNIVERSAL RECEPTACLE)

These accessories have been specifically designed for the adjustment at the rear of hermetically sealed universal receptacles. The choice of their dimensions depends on the PCB or on the thickness of the MIC box. These contacts and insulators are also compatible with SMA UNIVERSAL RECEPTACLES.

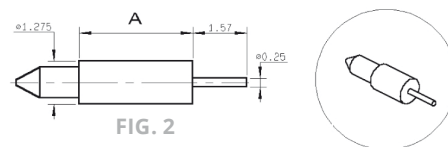
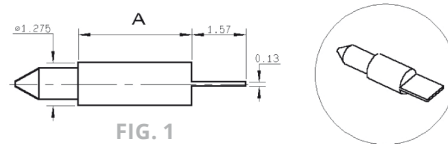
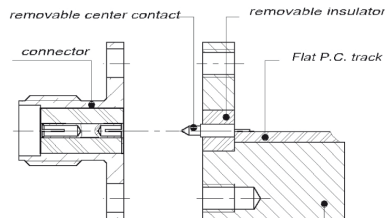

PART NUMBER	FIG.	A	NOTE	ASSOCIATED INSULATOR P/N
R280 461 000	1	3.37	Flat Tab	R280 468 000
R280 463 000	2		Cylindrical Tab	

FIELD-REPLACEABLE INSULATOR

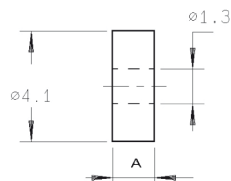

PART NUMBER	A	PACKAGING
R280 468 000	3.17	10

N 75Ω

PLUGS & JACKS

STRAIGHT PLUGS, FOR FLEXIBLE CABLES

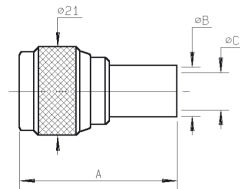
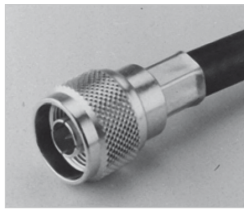

FIG. 1

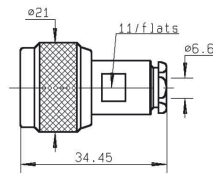

FIG. 2

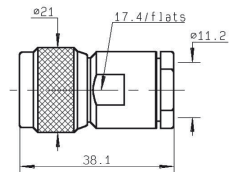
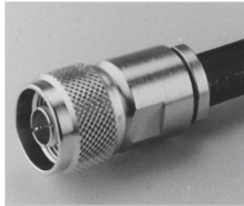

FIG. 3

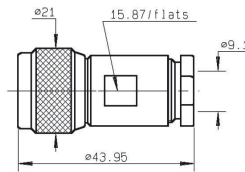

FIG. 4

CABLE GROUP	CABLE GROUP DIA.	PART NUMBER	FIG.	DIMENSIONS (MM)			CAPTIVE CENTER CONTACT	NOTE
				A	B DIA	C DIA		
RG59 / RG62	6/75/S	R162 084 000	1	33.9	6.6	4	Yes	Crimp Type
	6/75+93	R162 012 000	2	-	-	-	-	-
RG6	8/75/D	R162 013 000	3	-	-	-	No	Clamp Type
RG11 / RG12 / RG144 / RG216	10+11/75	R162 017 000	4	-	-	-	-	-

STRAIGHT JACKS, CLAMP TYPE, FOR FLEXIBLE CABLES

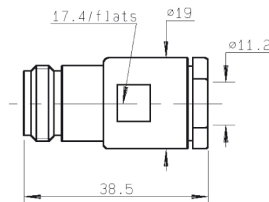
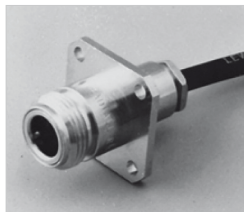
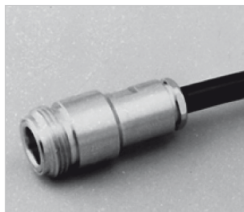

FIG. 1

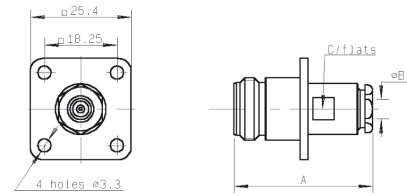
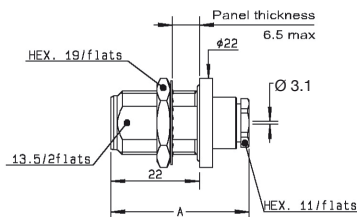

FIG. 2

CABLE GROUP	CABLE GROUP DIA.	PART NUMBER	FIG.	DIMENSIONS (MM)			CAPTIVE CENTER CONTACT	PANEL DRILLING	NOTE
				A	B	C			
RG11 / RG12 / RG144 / RG216	10+11/75	R162 217 000	1	-	-	-	No	-	-
RG59 / RG62	6/75+93/S	R162 262 000	2	34.9	6.6	11	-	P01	Square Flange

STRAIGHT BULKHEAD JACK, CLAMP TYPE, FOR FLEXIBLE CABLE (PANEL SEAL)



CABLE GROUP	CABLE GROUP DIA.	PART NUMBER	CAPTIVE CENTER CONTACT	PANEL DRILLING
RG179	2.6/75/S	R162 322 000	No	P11

N 75Ω

RECEPTACLES & ADAPTERS

FEMALE RECEPTACLES

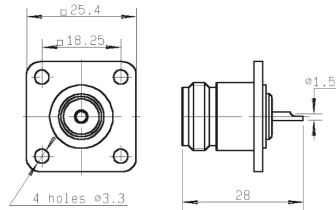

FIG. 1

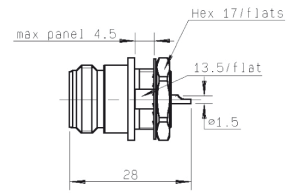

FIG. 2

PART NUMBER	FIG.	CAPTIVE CENTER CONTACT	PANEL DRILLING
R162 403 000	1	Yes	P05
R162 570 000	2		P12

IN SERIES ADAPTERS

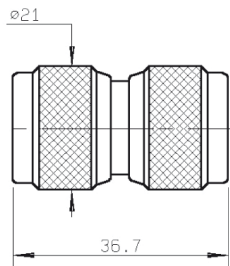

FIG. 1

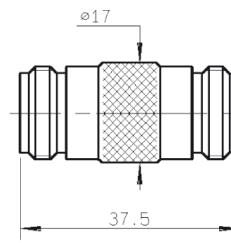

FIG. 2

PART NUMBER	FIG.	CAPTIVE CENTER CONTACT
R162 703 000	1	Yes
R162 705 000	2	

N

PANEL DRILLING

P01

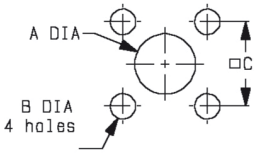

	MM		INCH	
	maxi	mini	maxi	mini
A	16.3	16.1	0.642	0.634
B	3.30	3.20	0.13	0.126
C	18.35	18.15	0.722	0.715

P02

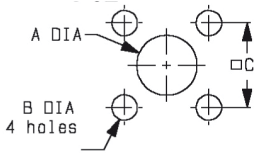

	MM		INCH	
	maxi	mini	maxi	mini
A	15.1	14.9	0.594	0.587
B	3.30	3.20	0.13	0.126
C	18.35	18.15	0.722	0.715

P03

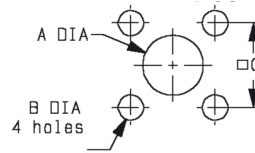

	MM		INCH	
	maxi	mini	maxi	mini
A	9.40	9.20	0.37	0.362
B	3.30	3.20	0.13	0.126
C	12.8	12.6	0.504	0.496

P04

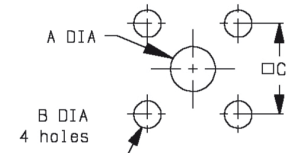

	MM		INCH	
	maxi	mini	maxi	mini
A	4.2	4.1	0.165	0.161
B	3.3	3.2	0.13	0.126
C	18.35	18.15	0.722	0.715

P05

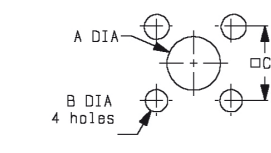

	MM		INCH	
	maxi	mini	maxi	mini
A Front	16.3	16.1	0.642	0.634
A Rear	15.1	14.9	0.594	0.587
B	3.30	3.20	0.13	0.126
C	18.35	18.15	0.722	0.715

P06

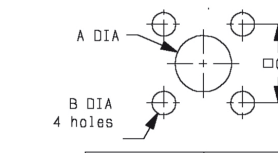

	MM		INCH	
	maxi	mini	maxi	mini
A Front	16.3	16.1	0.642	0.634
A Rear	4.2	4.1	.165	0.161
B	3.3	3.2	0.13	0.126
C	18.35	18.15	0.722	0.715

P07

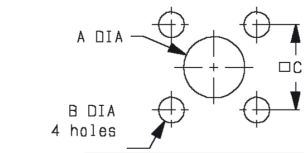

	MM		INCH	
	maxi	mini	maxi	mini
A Front	16.3	16.1	0.642	0.634
A Rear	12.5	12.3	0.492	0.484
B	3.3	3.2	0.13	0.126
C	18.35	18.15	0.722	0.715

P08

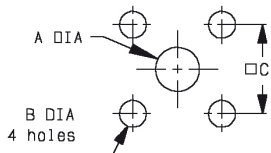

	MM		INCH	
	maxi	mini	maxi	mini
A	4.2	4.1	0.165	0.161
B	2.7	2.6	0.106	0.102
C	8.69	8.59	0.342	0.338

P09

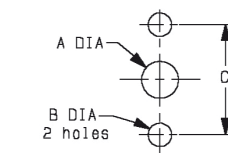

	MM		INCH	
	maxi	mini	maxi	mini
A	5	4.80	0.197	0.189
B	3.30	3.20	0.13	0.126
C	18.1	17.9	0.713	0.705

P10

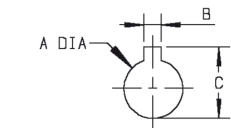

	MM		INCH	
	maxi	mini	maxi	mini
A	14.3	14.1	0.563	0.555
B	2.30	2.20	0.091	0.087
C	17	16.8	0.669	0.661

P11

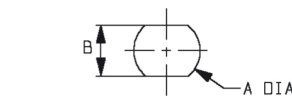

	MM		INCH	
	maxi	mini	maxi	mini
A	16.1	16	0.634	0.63
B	13.7	13.6	0.539	0.535

P12

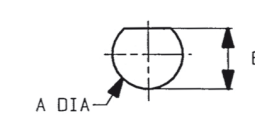

	MM		INCH	
	maxi	mini	maxi	mini
A	14.3	14.1	0.563	0.56
B	13.8	13.6	0.543	0.535

P13

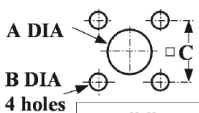

	mm	
	Maxi	mini
A	4.25	4.15
B	3.4	3.2
C	12.8	12.6

TNC



50Ω

DC - 11 GHz (standard and TNC Self-Lock)
DC - 18 GHz (TNC 18 GHz)

INTRODUCTION

GENERAL

- Screw-on equivalent to BNC bayonet series
- Good RF performance
- Suitable for high power levels
- Long life and high strength
- 4 ranges:
 - 18 GHz TNC series (50Ω)
 - TNC Self-Lock series 50 ohms

APPLICABLE STANDARDS

- MIL-C-39012 / MIL STD 348A/313
- IEC 60169-17
- CECC 22200

APPLICATIONS

- Avionics
- Aeronautics
- Countermeasures
- Telecommunications

TNC SELF-LOCK IS THE LATEST ADDITION TO THE TNC RANGE

TNC Self-Lock plugs are designed for civil aerospace applications. They are qualified for use in harsh and high vibration environments. Their specific anti-rotation coupling nut eliminates the need for safety lock wire, which results in significant time savings during installation on board the aircraft. They are fully compatible with all standard TNC receptacles and adapters.

TNC

INTERFACE N 50Ω

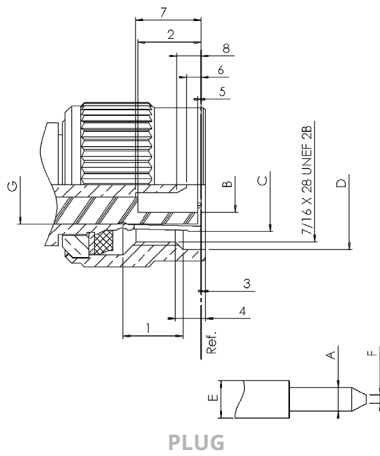

PLUG

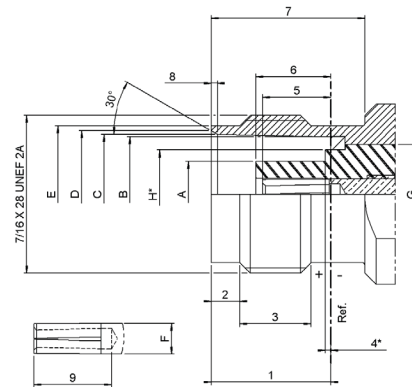

JACK

LETTER	MM		INCH	
	MIN	MAX	MIN	MAX
A	1.32	1.37	0.052	0.054
B	4.83	-	0.190	-
D	11.40	-	0.449	-
E	-	2.20	-	0.087
F	0.35	0.65	0.014	0.025
G	7.00	7.05	0.275	0.277
1	4.9	5.70	0.193	0.224
2	5.28	5.79	0.208	0.228
3	0.15	-	0.006	-
4	1.8	-	0.071	-
5	0.15	-	0.006	-
6	0.08	1.02	0.003	0.040
7	5.33	5.84	0.210	0.230
8	0.70	1.98	0.027	0.078

LETTER	MM		INCH	
	MIN	MAX	MIN	MAX
A	-	4.72	-	0.186
B	8.10	8.10	0.319	0.321
C	8.31	8.46	0.327	0.333
D	8.79	9.04	0.346	0.356
E	9.60	9.68	0.378	0.381
F	-	2.20	-	0.087
H	-	5.90	-	0.232
1	8.30	8.50	0.327	0.335
2	1.73	2.24	0.068	0.088
3	4.75	-	0.187	-
4	-	0.15	-	0.006
5	4.72	5.23	0.186	0.206
6	4.78	5.28	0.188	0.208
7	10.7	-	0.421	-
8	0.38	0.76	0.015	0.030
9	4.95	-	0.195	-

TNC

CHARACTERISTICS

TEST / CHARACTERISTICS	STANDARD REFERENCE	VALUES / REMARKS	
ELECTRICAL CHARACTERISTICS			
Impedance	-	50Ω	-
Frequency Range	-	DC - 11 GHz	-
V.S.W.R.	3-14	1.30 max	-
Insertion Loss	3-27	0.18 dB max at 9 GHz	-
RF Leakage	3-26	-60 dB min from 2 to 3 GHz	-
Insulation Resistance	3-11	5000 MΩ min	-
Contact Resistance	3-16	Initial	-
• Center Contact (mΩ)	-	1.5	-
• Outer Contact (mΩ)	-	0.2	-
Working Voltage	-	At Sea Level: 500 V rms	-
Dielectric Withstanding Voltage	3-17	At Sea Level: 1500 V rms	-
RF Withstanding Voltage	3-23	At Sea Level: 1000 V rms (5 MHz Sine Wave)	-

MECHANICAL CHARACTERISTICS

Durability	3-15	500 Matings	
Mating / Unmating	-	Axial force: Not Applicable Torque: 1.96 inch pounds (22.6 N.cm)	
Recommended Mating Torque	-	3.99 to 5.98 inch pounds (46 to 69 N.cm)	
Proof Torque	-	14.74 inch pounds (170 N.cm)	
Coupling Mechanism Retention Force	3-25	100 Lbf (44.5 daN)	
Cabling Retention Force	3-24	Cable Clamp:	40.6 Lbf (181 N min) (all cables)
		Crimped:	51 Lbf (227 N min) (cable dia. .189 (4.8) to .228 (5.8))
			76.4 Lbf (340 N min) (cable dia. .250 (6.35) and above)
Center Contact Retention	-	Axial: 6.06 Lbf (27 N)	

ENVIRONMENTAL CHARACTERISTICS

Temperature Range	-	-65 °C / + 165 °C	
• Standard Models	-	-65 °C / +100 °C	
• Hermetic Sealed Models	-	-65 °C / +105 °C	
• Models for Semi-Rigid Cables	-		
Thermal Shock	3-20	MIL-STD-202, Method 107, Condition B	
High Temperature Endurance	-	MIL-STD-202, Method 108	
Corrosion (Salt Spray)	3-13	MIL-STD-202, Method 101, Condition B	
Vibrations	3-18	MIL-STD-202, Method 204, Condition B	
Shocks	3-19	MIL-STD-202, Method 213, Condition G	
Moisture Resistance	3-21	MIL-STD-202, Method 106	
Low Pressure	3-22	Not Applicable	
Hermetic Seal	-	Applied Vacuum 10 ⁻⁶ mm of Hg (Torrs) Leakage Rate < 10 ⁻⁶ atm/cm ³ /s	
Leakage	-	Pressure 3.5 bars; Duration 2 mn; Temperature 15 °C to 25 °C	

MATERIALS AND PLATING

Body and Center Pin Contact	Brass as per QQ-B-626	Nickel Plated
Center Socket Contact	Beryllium Copper as per QQ-C-530	Gold Plated
Ferrules	Brass	-
Insulators	PTFE Teflon	-
Gaskets	Silicone Elastomer	-

Notes

All dimensions are given in mm.

TNC

CHARACTERISTICS COMMERCIAL TNC

TEST / CHARACTERISTICS	VALUES / REMARKS
------------------------	------------------

ELECTRICAL AND ENVIRONMENTAL CHARACTERISTICS

Impedance	-
Frequency Range	DC - 1.5 GHz
Test Voltage	1500 V rms
Operating Voltage	500 V rms
Insulation Resistance	5000 M Ω min (500 V)
Contact Resistance	10 m Ω max
Temperature Range	-35 °C / +70 °C

PLATING

Body	Nickel
Center Contacts	Gold

*TNC Self-Lock***INTRODUCTION**

Radiall introduces a new innovative technology in response to market demands to eliminate locking wires.

Radiall's Self-Lock RF connectors are the perfect solution to provide secure connection-facing vibrations experienced in aerospace applications.

The Self-Locking design is intended to eliminate the need for safety wires and saves many hours, the locking feature is achieved via a spring loaded, corrugated washer.

Self-Lock connectors are intermatable with any standard jack or female receptacle; there is no change in performance. All electrical, mechanical and environmental specifications are preserved. With this solution, mating-unmating becomes faster, safer (no forgotten lock wire) and is proven to be more robust even in the harsh environment of an airplane bilge.

The Self-Lock connectors can be provided on any compatible cable size. The innovative crimp system attachment offers the opportunity for on-site assembly as well as ordering finished cable assemblies.

FEATURES & BENEFITS

- No locking wire
- Secure connection in harsh environments
- Easy and fast to install
- Self-Lock plugs compatible with standard jacks and receptacles



TNC Self-Lock

PLUGS
STRAIGHT PLUG CRIMP TYPE CABLE

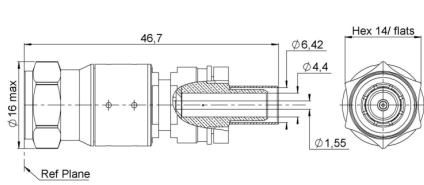

FIG. 1

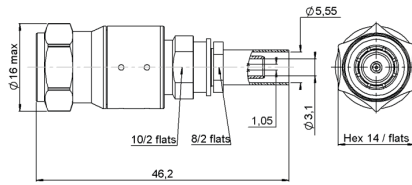

FIG. 2

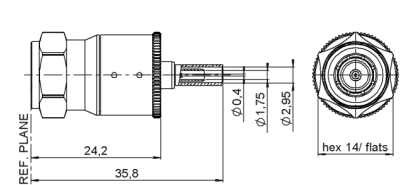

FIG. 3

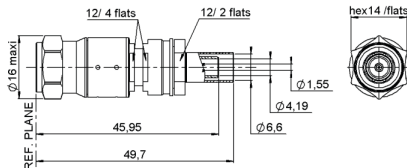

FIG. 4

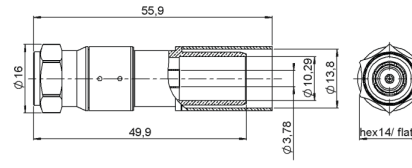

FIG. 5

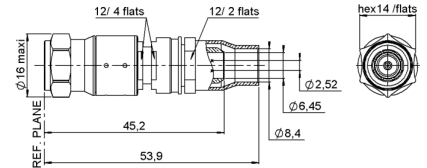

FIG. 6

CABLE GROUP	PART NUMBER	FIG.
EN4604-010 KX	R143 064 510	1
RG 142 AU / RG 142 BU	R143 065 580	2
RG 179 / STUDY 132868 / STUDY 132869	R143 075 580	3
ECS 311501 / ECS 311601	R143 083 580	4
ECS 310701	R143 089 580	5
ECS 311201	R143 092 580	6

STRAIGHT PLUG CRIMP TYPE

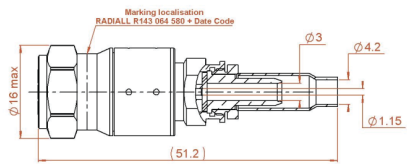

FIG. 1

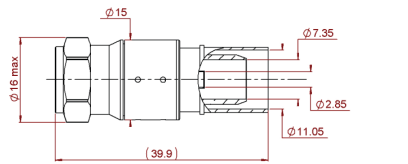

FIG. 2

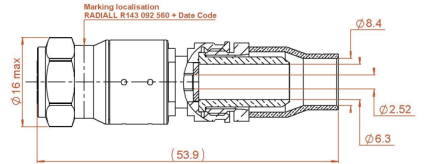

FIG. 3

CABLE GROUP	PART NUMBER	FIG.
EN4604-006 WM	R143 064 580	1
LMR 400 / AEP-400FR / BELN 9913 / LMR 400 FR	R143 089 110	2
EN4604-007 W	R143 092 560	3

RIGHT ANGLE PLUG CRIMP TYPE CABLE

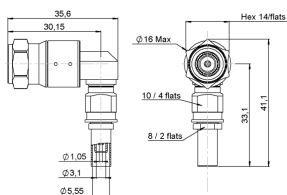

FIG. 1

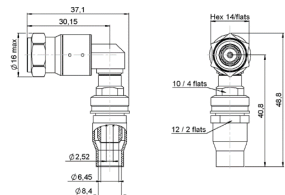

FIG. 2

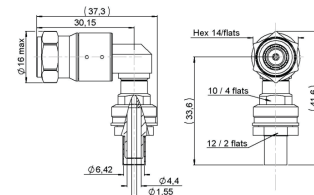

FIG. 3

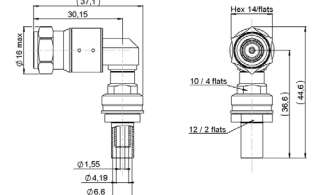

FIG. 4

CABLE GROUP	PART NUMBER	FIG.
RG 142 AU / RG 142 BU	R143 182 580	1
ECS 311201	R143 183 580	2
EN4604-010 KX	R143 184 510	3
ECS 311501 / ECS 311601	R143 184 580	4

TNC 50Ω

PLUGS

STRAIGHT PLUGS CRIMP TYPE FOR FLEXIBLE CABLE

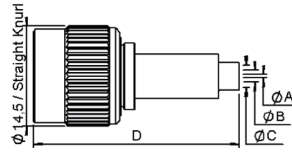

FIG. 1

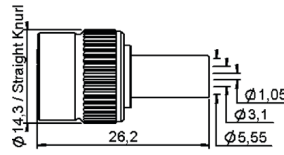

FIG. 2

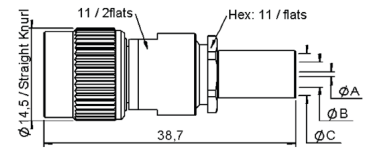

FIG. 3

CABLE GROUP	CABLE GROUP DIA.	PART NUMBER	FIG.	DIMENSIONS (MM)				CAPTIVE CENTER CONTACT	PACKAGING	NOTE
				A	B	C	D			
RG174 / RG316 / AEP-100FR	2.6/50/S & LMR® 100	R143 075 000	1	0.6	1.75	3.25	29.6	Yes	100 Pieces	-
RG141 / RG58	5/50/S	R143 080 000		1.05	3.1	5.5	26.6			
AEP-195FR	LMR® 195	R143 082 027		1.05	3.1	5.55	26.6			
AEP-200FR	LMR® 200	R143 082 200		1.27	3.1	5.55	26.6			
AEP-240FR	LMR® 240	R143 084 161		1.5	4.05	6.6	28.2			
AEP-400FR	LMR® 400	R143 089 117		2.85	7.8	11.05	27.85			
RG58 / RG141	5/50/S	R143 082 000	2	-	-	-	-	No	Unit	Full Crimp Commercial Version, Full Crimp
		R143 082 161		-	-	-	-			
		R143 072 000		1.05	3.1	5.55	-			
RG142 / RG223 / RG400	5/50/D	R143 073 000	3	1.05	3.1	5.55	-	Yes	Unit	-
		R143 083 000		1.05	3.1	5.5	26.6			

STRAIGHT PLUGS CLAMP TYPE FOR FLEXIBLE AND SEMI RIGID CABLE

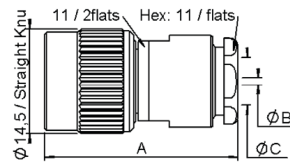

FIG. 1

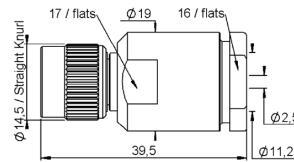

FIG. 2

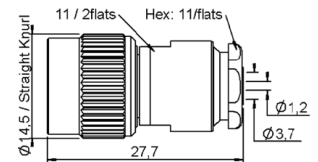

FIG. 3

CABLE GROUP	CABLE GROUP DIA.	PART NUMBER	FIG.	DIMENSIONS (MM)			CAPTIVE CENTER CONTACT	PACKAGING	NOTE
				A	B	C			
RG174 / RG316 / RD316 / RG179 / RD179	2.6/50+75	R143 004 000	1	26.5	0.6	3.1	Yes	Unit	-
RG58 / RG141 / RG142 / RG223 / RG400	5/50/S+D	R143 008 000		27.1	1.2	5.6	No	100 Pieces	Conical Braid Clamp
RG59 / RG62	6/75+93	R143 012 000		27	1.05	6.65	Yes	Unit	
RG213 / RG393 / RG214	10+11/50	R143 018 000	2	-	-	-			No
		R143 018 500		-	-	-			
RG402	.141"	R143 052 000	3	-	-	-	No	Unit	-

TNC 50Ω

RIGHT ANGLE PLUGS CRIMP AND SOLDER TYPE

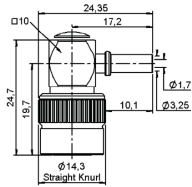

FIG. 1

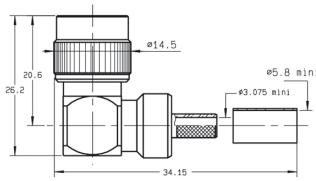

FIG. 2

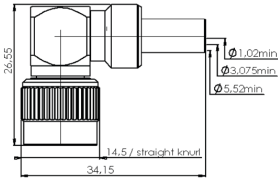

FIG. 3

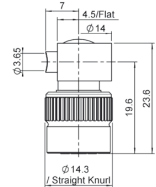
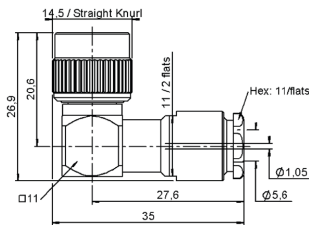
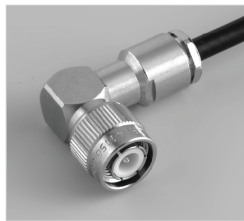

FIG. 4

CABLE GROUP	CABLE GROUP DIA.	PART NUMBER	FIG.	CAPTIVE CENTER CONTACT	PACKAGING	NOTE
RG174 / RG316	2.6/50/S	R143 181 161	1	Yes	100 Pieces	Commercial Version
RG58 / RG141	5/50/S	R143 182 000	3		-	
RG142 / RG223 / RG400	5/50/D	R143 183 000	2		-	
RG402	.141"	R143 154 000	4		100 Pieces	Solder Type

RIGHT ANGLE PLUG CLAMP TYPE, FOR FLEXIBLE CABLE



CABLE GROUP	CABLE GROUP DIA.	PART NUMBER	CAPTIVE CENTER CONTACT	PACKAGING
RG58 / RG141 / RG142 / RG223 / RG400	5/50/S+D	R143 156 000 R143 156 100	Yes	Unit

JACKS

STRAIGHT JACKS CRIMP TYPE, FOR FLEXIBLE CABLE

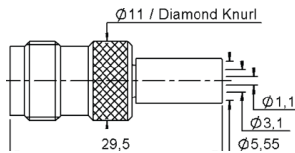

FIG. 1

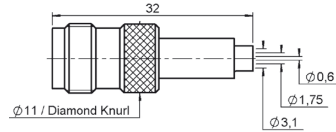

FIG. 2

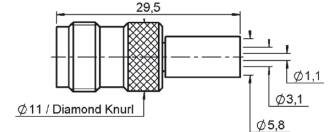
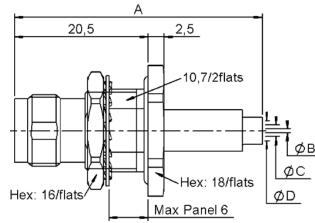

FIG. 3

CABLE GROUP	CABLE GROUP DIA.	PART NUMBER	FIG.	CAPTIVE CENTER CONTACT	PACKAGING	NOTE
RG174 / RG316 / RD316	2.6/50/S + D	R143 237 000	2	Yes	Unit	-
RG58 / RG141	5/50/S	R143 235 161	1		100 Pieces	Commercial Version, Full Crimp
RG142 / RG223 / RG400	5/50/D	R143 236 020	3		Unit	-

TNC 50Ω

STRAIGHT BULKHEAD JACKS CRIMP TYPE, FOR FLEXIBLE CABLE



CABLE GROUP	CABLE GROUP DIA.	PART NUMBER	DIMENSIONS (MM)				CAPTIVE CENTER CONTACT	PANEL DRILLING	PACKAGING	NOTE
			A	B	C	D				
RG174 / RG316	2.6/50/S	R143 331 161	38	0.6	1.75	3.10	Yes	P08+P10	100 Pieces	Commercial Version, Panel Sealed
RG58 / RG141	5/50/S	R143 332 161	35	1.05	3.10	5.55				Commercial Version, Panel Sealed, Full Crimp

STRAIGHT JACKS CLAMP TYPE, FOR FLEXIBLE CABLE

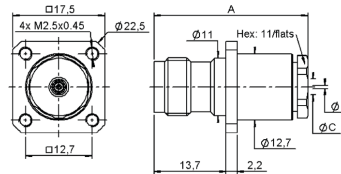

FIG. 1

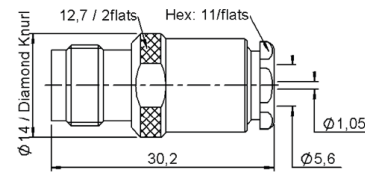
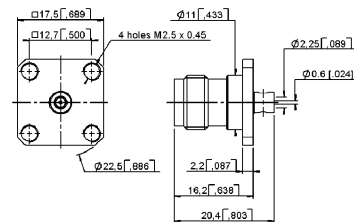

FIG. 2

CABLE GROUP	CABLE GROUP DIA.	PART NUMBER	FIG.	DIMENSIONS (MM)			CAPTIVE CENTER CONTACT	PANEL DRILLING	PACKAGING	NOTE
				A	B	C				
RG174 / RG316 / RD316 / RG179 / RD179	2.6/50/S	R143 254 000	1	29.8	0.6	3.1	Yes	P04	Unit	Square Flange Also for Screws Type 3-56 UNF 2A
RG58 / RG141 / RG142 / RG223 / RG400	5/50/S+D	R143 258 000		30.2	1.05	5.6	No			
RG58 / RG141	5/50/S	R143 207 000	2	-	-	-	-	-	-	-

SQUARE FLANGE STRAIGHT JACK SOLDER TYPE, FOR SEMI-RIGID CABLE



CABLE GROUP	CABLE GROUP DIA.	PART NUMBER	CAPTIVE CENTER CONTACT	PANEL DRILLING	PACKAGING
RG405	.085"	R143 257 440	No	P01	Unit

TNC 50Ω

JACKS & RECEPTACLES STRAIGHT BULKHEAD JACKS PANEL SEALED

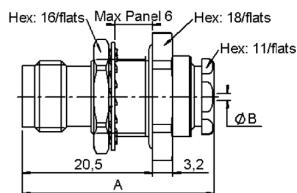

FIG. 1

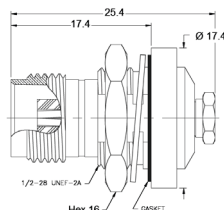

FIG. 2

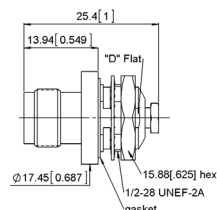

FIG. 3

CABLE GROUP	CABLE GROUP DIA.	PART NUMBER	FIG.	DIMENSIONS A (MM)	CAPTIVE CENTER CONTACT	PANEL DRILLING	NOTE
RG178 / RG196	2/50/S	R143 323 000	1	29.9	Yes	P08	Rear Mount
RG174 / RG316 / RD316	2.6/50	R143 324 000		29.6			
RG58 / RG141	5/50/S	R143 325 000		30.17			
RG402	.141"	R143 337 000		30.8			
RG174 / RG316	2.6/50/S	6001-7051-003	2	-	Yes		Front Mount
RG405	.085"	6001-7041-010		-			
RG178 / RG196	2/50/S	6002-7051-002	3	-			
RG178 / RG196	2/50/S	6002-7551-202		-			
RG174 / RG316	2.6/50/S	6002-7051-003		-			
RD316	2.6/50/D	6002-7551-219		-			
RG58 / RG141	5/50/S	6002-7551-106		-			

SQUARE FLANGE STRAIGHT FEMALE RECEPTACLES

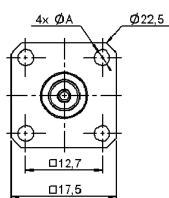

FIG. 1

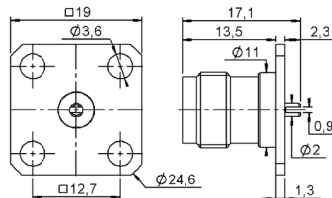

FIG. 2

PART NUMBER	FIG.	DIMENSIONS A (MM)	CAPTIVE CENTER CONTACT	PANEL DRILLING	PACKAGING	NOTE
R143 404 000	1	M2.5 x 0.45	Yes	P05	Unit	Solder Pot 17.5 mm Square Flange
R143 405 000		2.6			100 Pieces	
R143 420 000	2	-	No	P02	-	Slotted Contact 19 mm Square Flange

BULKHEAD STRAIGHT FEMALE RECEPTACLES

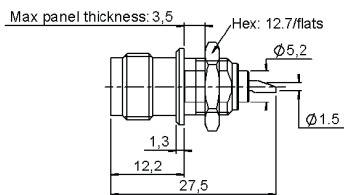

FIG. 1

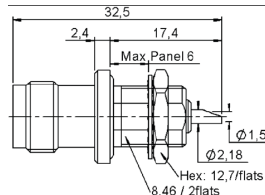

FIG. 2

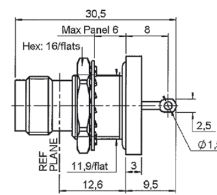
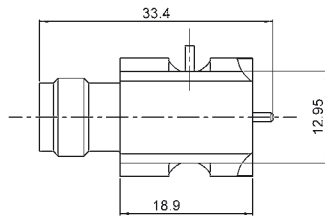

FIG. 3

PART NUMBER	FIG.	CAPTIVE CENTER CONTACT	PANEL DRILLING	PACKAGING	NOTE
R143 557 000	1	Yes	P07	Unit	Front Mount, Solder Pot Contact
R143 603 000	2		P09		Panel Sealed, Front Mount, Solder Pot Contact
R143 626 000	3		P11		Hermetic, Panel Sealed, Rear Mount

TNC 50Ω

RECEPTACLES & CAPS RF POWER SWITCHING CONNECTORS



PART NUMBER	TYPE
R143 422 947	Left
R143 422 957	Right

SQUARE FLANGE RIGHT ANGLE FEMALE RECEPTACLE

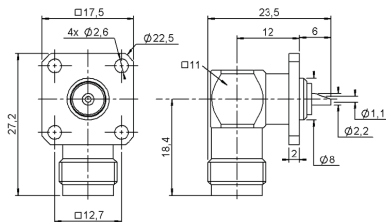

PART NUMBER	CAPTIVE CENTER CONTACT	PANEL DRILLING	PACKAGING	NOTE
R143 654 000	Yes	P06	Unit	Solder Pot Contact

SQUARE FLANGE STRAIGHT MALE RECEPTACLE

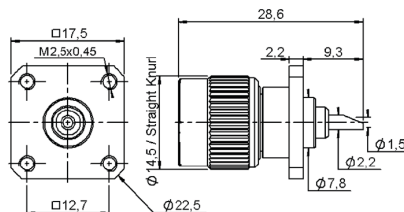

PART NUMBER	CAPTIVE CENTER CONTACT	PANEL DRILLING	PACKAGING	NOTE
R143 440 000	Yes	P03	Unit	Solder Pot Contact

PROTECTIVE CAPS

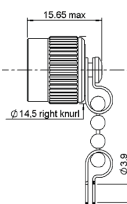

FIG. 1

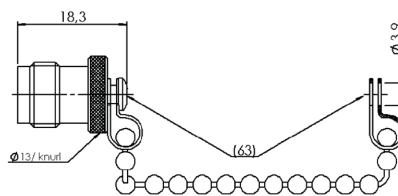

FIG. 2

PART NUMBER	FIG.	FINISH	PACKAGING	NOTE
R143 812 000	1	Nickel	Unit	Male with Chain
R143 835 000	2		100 Pieces	Female with Chain

TNC 50Ω

ADAPTERS IN SERIES ADAPTERS

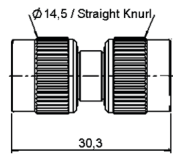

FIG. 1

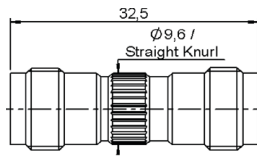

FIG. 2

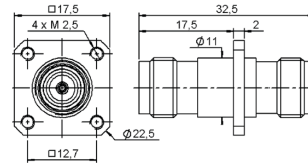

FIG. 3

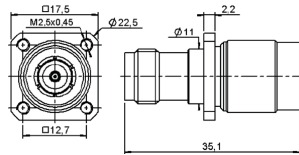

FIG. 4

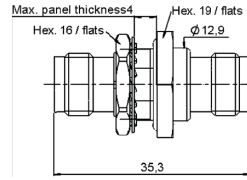

FIG. 5

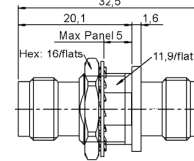

FIG. 6

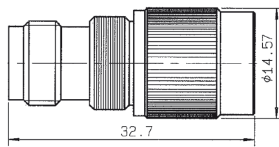

FIG. 7

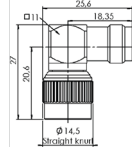

FIG. 8

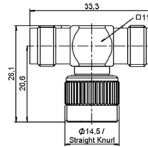

FIG. 9

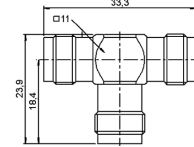

FIG. 10

PART NUMBER	FIG.	CAPTIVE CENTER CONTACT	PANEL DRILLING	PACKAGING	NOTE
R143 703 000	1	Yes	-	Unit	Male - Male
R143 704 000	2				Female - Female
R143 710 000	3				Square Flange Female - Female
R143 713 000	4		P01	100 Pieces	Square Flange Slide on Type Male - Female
R143 753 000	5				Bulkhead Hermetic, Panel Sealed Female - Female
R143 720 000	6		P08	100 Pieces	Commercial Version, Bulkhead Female - Female
R143 713 200	7				Female - Male Push-On
R143 770 000	8		-	Unit	Right Angle Male - Female
R143 780 000	9				Female - Female - Male
R143 782 000	10				Female - Female - Female

TNC

PLUGS & JACKS

STRAIGHT PLUGS CRIMP TYPE FOR FLEXIBLE CABLE

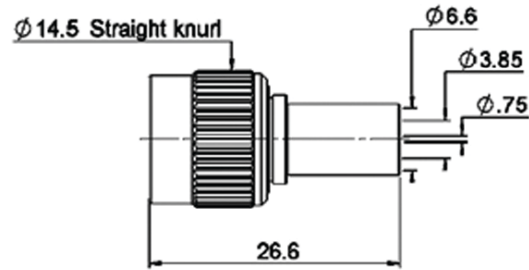

CABLE GROUP	CABLE GROUP DIA.	PART NUMBER	CAPTIVE CENTER CONTACT	NOTE
RG59 / RG62	6/75 + 93	R144 085 000	No	Full Crimp
		R144 085 161	Yes	Commercial Version - Full Crimp

STRAIGHT BULKHEAD JACK CRIMP TYPE FOR FLEXIBLE CABLE

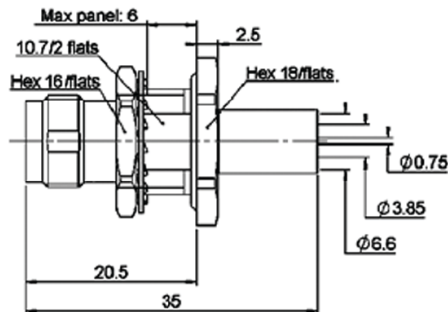

CABLE GROUP	CABLE GROUP DIA.	PART NUMBER	CAPTIVE CENTER CONTACT	PANEL DRILLING	PACKAGING	NOTE
RG59 / RG62	6/75 + 93	R144 334 161	Yes	P08 or P10	100 Pieces	Commercial Version - Panel Sealed

TNC

PANEL DRILLING

P01

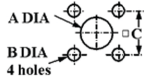

	MM		INCH	
	maxi	mini	maxi	mini
A	11.3	11.2	0.445	0.441
B	2.7	2.6	0.106	0.102
C	12.75	12.65	0.502	0.498

P02

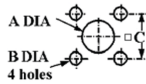

	MM		INCH	
	maxi	mini	maxi	mini
A	11.3	11.2	0.445	0.441
B	3.7	3.6	0.146	0.142
C	12.75	12.65	0.502	0.498

P03

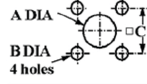

	MM		INCH	
	maxi	mini	maxi	mini
A	7.9	7.8	0.311	0.307
B	2.7	2.6	0.106	0.102
C	12.75	12.65	0.502	0.498

P04

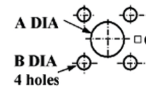

	MM		INCH	
	maxi	mini	maxi	mini
A (F. Mount)	13	12.9	0.512	0.508
A (R. Mount)	11.3	11.2	0.445	0.441
B	2.7	2.6	0.106	0.102
C	12.75	12.65	0.502	0.498

P05

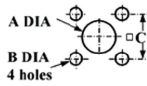

	MM		INCH	
	maxi	mini	maxi	mini
A F.mount	8	7.9	0.315	0.311
A R.mount	11.3	11.2	0.445	0.441
B	2.8	2.7	0.11	0.106
C	12.75	12.65	0.502	0.498

P06

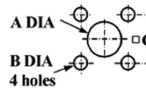

	MM		INCH	
	maxi	mini	maxi	mini
A	8.3	8.2	0.327	0.323
B	2.7	2.6	0.106	0.102
C	12.75	12.65	0.502	0.498

P07



	MM		INCH	
	maxi	mini	maxi	mini
A	9.8	9.7	0.386	0.382
B	8.93	8.81	0.352	0.347

P08



	MM		INCH	
	maxi	mini	maxi	mini
A	12.8	12.7	0.504	0.5
B	12.1	12	0.476	0.472

P09

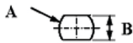

	MM		INCH	
	maxi	mini	maxi	mini
A	9.75	9.65	0.384	0.38
B	8.65	8.55	0.341	0.337

P10

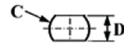

	MM		INCH	
	maxi	mini	maxi	mini
C	12.8	12.7	0.504	0.5
D	10.9	10.8	0.429	0.425

P11

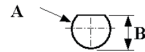

	mm	
	Maxi	mini
A	12.9	12.8
B	12.1	12

C Connectors



50Ω	DC - 11 GHz (maximum) DC - 3 GHz (optimized)
-----	---

INTRODUCTION

GENERAL

- Standard coaxial connectors
- Bayonet coupling

APPLICABLE STANDARDS

- MIL-C-39012 A
- MIL-C-3898 A
- MIL-C-23329 A
- IEC 169-7

APPLICATIONS

- Civil aerospace
- Maintenance

Type C connectors were engineered in the late 1940s. It is similar to type N but with a bayonet coupling for rapid connection and disconnection.

INTERFACE

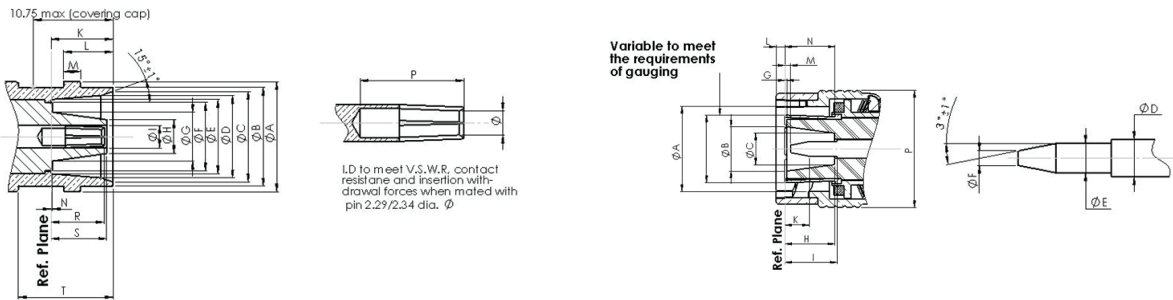

CEI DIMENSIONS (IN MM)

	JACK			PLUG	
	MIN	MAX		MIN	MAX
ØA	14.99	15.24	ØA	13.79	13.94
ØB	13.46	13.72	ØB	7.01	-
ØC	12.32	12.57	ØC	4.92	-
ØD	11.18	11.43	ØD	3.02	3.15
ØE	10.44	10.54	ØE	2.29	2.34
ØF	-	9.50	ØF	-	1.27
ØG	-	6.91	ØG	0.18	-
ØH	-	4.83	ØH	7.80	8.56
ØI	3.02	3.15	ØI	7.85	-
K	8.43	8.59	K	4.85	6.38
L	7.80	7.95	L	-	2.16
M	2.24	2.49	M	0.09	1.02
N	-	0.18	N	7.54	7.72
P	7.62	-	P	-	19.84
Q	-	-	-	-	-
R	6.93	7.70	-	-	-
S	-	7.85	-	-	-
T	12.57	-	-	-	-

C Connectors

CHARACTERISTICS

TEST / CHARACTERISTICS	VALUES / REMARKS
------------------------	------------------

ELECTRICAL CHARACTERISTICS

Impedance	50Ω
Frequency Range	DC - 3 GHz (Optimized) DC - 11 GHz (Maximum)
V.S.W.R.	1.22 at 3 GHz
Test Voltage at Sea Level	3 Kv Continuous
Insulation Resistance	> 5000 MΩ

MECHANICAL CHARACTERISTICS

Durability	500 Matings
Vibrations	10g (Acceleration) 10 to 500 Hz

ENVIRONMENTAL CHARACTERISTICS

Temperature Range	-55 °C / + 155 °C
Salt Spray	48H
Panel Sealing	Pressure: 3 bars Leakage Rate < 1 cm ³ /h

MATERIALS AND PLATING

Outer Contact	Bronze	Gold
Connector Body	Brass / Stainless Steel	Nickel / Passivated
Insulator	PTFE	-
Gaskets	Silicone Rubber	-

C Connectors

PLUGS & JACKS

STRAIGHT PLUGS, FOR FLEXIBLE CABLE

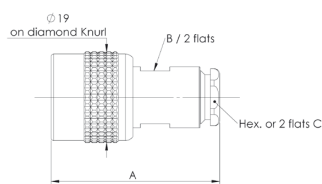

FIG. 1

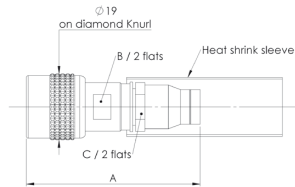

FIG. 2

CABLE GROUP	CABLE GROUP DIA.	PART NUMBER	FIG.	DIMENSIONS (MM)			CAPTIVE CENTER CONTACT	NOTE
				A	B	C		
RG58 / RG141	5/50/S	R166 005 000	1	35	11	11	No	Clamp Type
RG213 / RG214	10/50/S 11/50/D	R166 018 000	1	38	16	16		
ASNE WD+WN	8/50	R166 092 190	2	50.25	12	12	Yes	Crimp Type
F1703-93	4.3/50/D	R166 093 000		49.5	10	8		
Special ASNE	5/50/D	R166 094 000		46.45	12	12	No	
ASNE WZ	3.6/50S	R166 088 100		42.55	12	8		

RIGHT ANGLE PLUGS, FOR FLEXIBLE CABLE

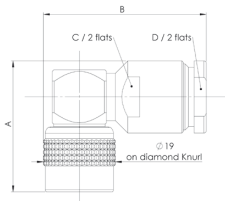

FIG. 1

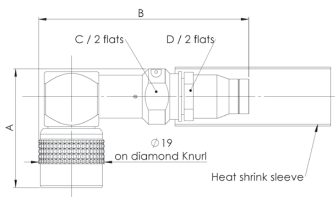

FIG. 2

CABLE GROUP	CABLE GROUP DIA.	PART NUMBER	FIG.	DIMENSIONS (MM)				CAPTIVE CENTER CONTACT	NOTE
				A	B	C	D		
Special	7/50/D	R166 160 020	1	31.3	-	15.8	16	Yes	Clamp Type
RG213 / RG214	10/50/S 11/50/D	R166 168 000		34.5	43	16	16		
F1703-93	4.3/50/D	R166 191 000	2	34.3	52.6	14	12		Crimp Type
ASNE WD+WN	8/50	R166 194 190		34.3	60.8	14	12		

STRAIGHT JACKS, FOR FLEXIBLE CABLE

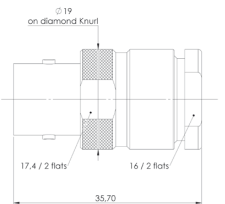

FIG. 1

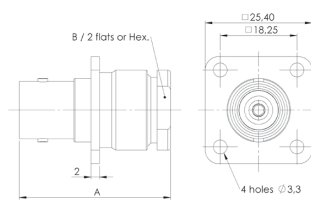
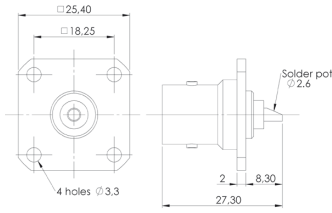

FIG. 2

CABLE GROUP	CABLE GROUP DIA.	PART NUMBER	FIG.	DIMENSIONS (MM)		CAPTIVE CENTER CONTACT	NOTE
				A	B		
RG213 / RG214	10/50/S 11/50/D	R166 218 000	1	-	-	No	Clamp Type
Special ASNE	5/50/D	R166 256 000	2	32	12.7		
RG213 / RG214	10/50/S 11/50/D	R166 268 000		35.7	19		

C Connectors

RECEPTACLES & IN SERIES ADAPTERS
SQUARE FLANGE, STRAIGHT FEMALE RECEPTACLES



PART NUMBER	CAPTIVE CENTER CONTACT	PANEL DRILLING	FINISH
R166 404 000	Yes	P01	Brass / Nickel
R166 404 001			Stainless Steel Passivated

IN SERIES ADAPTERS

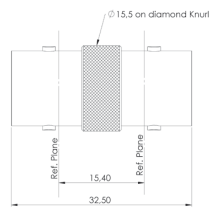

FIG. 1

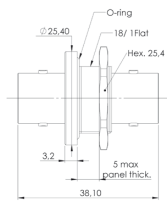

FIG. 2

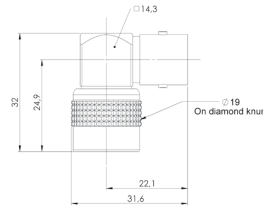
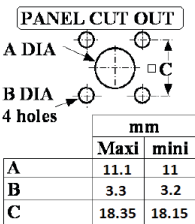

FIG. 3

PART NUMBER	FIG.	PANEL DRILLING	NOTE
R166 705 000	1	-	Female - Female
R166 753 000	2	P02	Female - Female / Bulkhead / Hermetic
R166 770 000	3	-	Male - Female / Right Angle

PANEL DRILLING

P01



P02

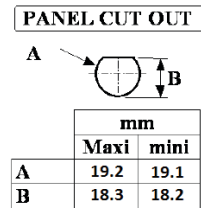

Notes

Mouser Electronics

Authorized Distributor

Click to View Pricing, Inventory, Delivery & Lifecycle Information:

[Radial:](#)

[R161254025W](#) [R161156000W](#) [R161805000W](#) [R161183410W](#) [R161051102W](#) [R161404450](#) [R161606501W](#)
[R161030000W](#) [R161181335W](#) [R161183410](#) [R161804004](#) [R161804004W](#) [R161819010W](#) [R161404437](#)
[R161753050W](#) [R161051200W](#)