

Produkt-Nr.:		1	2	3	4	5	6	7	8	9	0	00			
6450.xxx_End-Nr.	000	001	002	003	004	005	006	007	008	009	010	011			
Produkt-Nr.:														+	-
6450.xxx_End-Nr.														028	029
Produkt-Nr.:		•				#									
6450.xxx_End-Nr.		031				035									
Produkt-Nr.:								C		E				H	
6450.xxx_End-Nr.								053		055				058	
Produkt-Nr.:	J		L	M	N	O		Q	R	S			V	W	X
6450.xxx_End-Nr.	060		062	063	064	065		067	068	069			072	073	074
Produkt-Nr.:	Y	Z													
6450.xxx_End-Nr.	075	076													
Produkt-Nr.:						⊕				⇨					
6450.xxx_End-Nr.						095				099					
Produkt-Nr.:														?	↘
6450.xxx_End-Nr.														162	164
Produkt-Nr.:	☐	⇨		→	•										
6450.xxx_End-Nr.	165	166		168	169										
Produkt-Nr.:															
6450.xxx_End-Nr.															
Produkt-Nr.:															
6450.xxx_End-Nr.															

blue	blau	9
white	weiß	
green	gruen	8
white	weiß	
yellow	gelb	7
white	weiß	
red	rot	6
white	weiß	
anthracite	anthrazit	5
white	weiß	
brown	braun	4
white	weiß	
dark grey	dunkelgrau	3
white	weiß	
	ergograu	2
grey	grau	1
white	weiß	
Key-button	Tastenkopf	End-Nr.
Sign	Zeichen	

Die Zeichen entsprechen etwa der Darstellung!
Sign correspond nearly to representation!

* Anmerkung: Die mit ◻ (ohne Zeichen) und ◼ (mit Zeichen) versehenen Ausfuehrungen entsprechen dem Standardprogramm. Alle nicht so gekennzeichneten Zeichen und Farben sind nur auf Anfrage lieferbar!
Bei Bestellung von Tastenknoepfen ohne Zeichen bleibt die End-Nr. entsprechend der Tastenknoepf farbe dieselbe.

All versions which are marked ◻ (with out sign) and ◼ (with sign) are according to our standard program. All symbols and colours which are not marked in that way are available on request only!
In case there are ordered buttons without symbol, the last 3 digits of the number remain unchanged which is in accordance with the number of the button's colour.

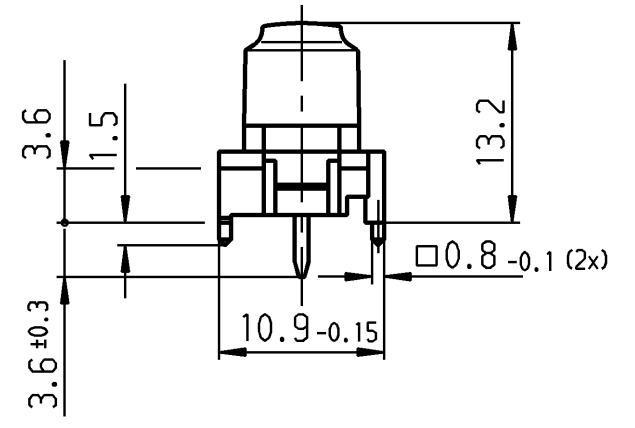

Recommended cut-out for snap-in fixing
(edge opposite to snap-in direction)
Empfohlener Ausschnitt fuer Rastbefestigung
(Grat gegenueber Bestueckungsseite)

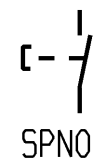
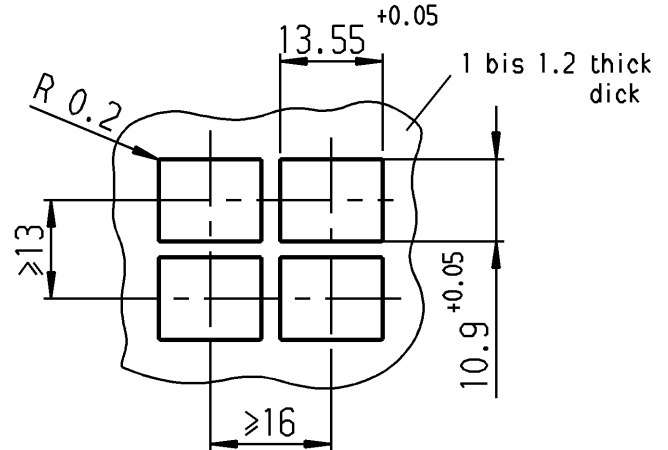

SPNO
total travel
actuating force
voltage
rating

Schließer 1-polig
Gesamtweg 1.4 mm ±0.2mm
Betaetigungskraft ca. 0.7 N
Schaltspannung max. 28 V
Schaltstrom max. 100 mA

Marking
Aufschrift
Ⓜ

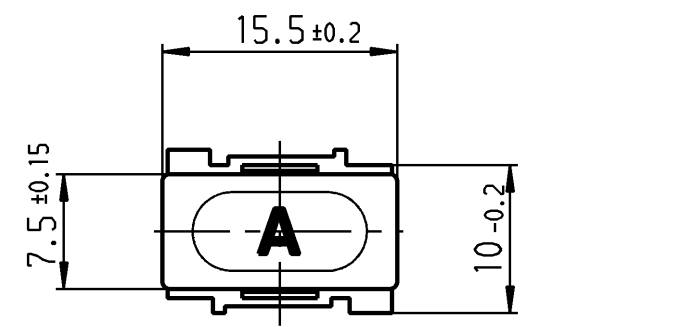

Recommended terminal layout, side of component;
tolerance as per DIN IEC 326 item 3 very fine.
Empfohlenes Lochbild, Bauteilseite;
Toleranz nach DIN IEC 326 Teil 3 sehr fein

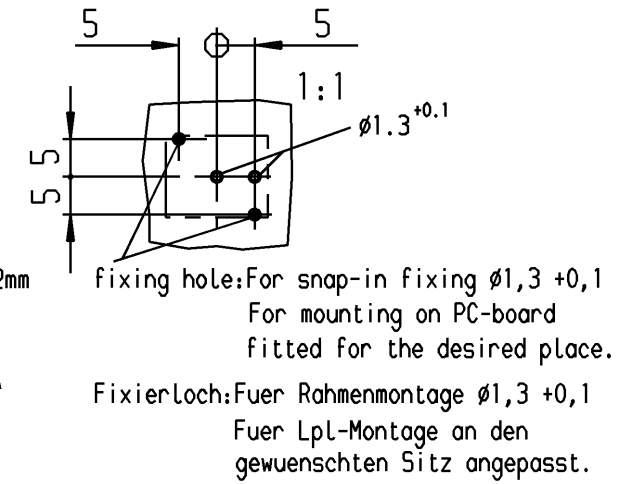

Allgemeintoleranzen/UNTOLERANCED DIMENSIONS				PROJECTION		Pause COPY		Blatt SHEET		Zeichn./DRAWING NO.	
Für Längen und Radien FOR LENGTHS AND RADII.		Abmaße in mm für Nennmaßbereich in mm ALL DIMENSIONS ARE IN MILLIMETRES			☐		Original DIN A3		K 6450.0001		
±		bis/UP TO 6	über/OVER 6 bis/UP TO 30	über/OVER 30	☉		Maßstab SCALE 2:1		Taste Keyboard-switch		
x	57376	18.03.08	BRC	s	35612	15.05.03	wj	gez./DRAWN BY 17.11.88 ws		MARQUARDT	
w	48579	05.06.07	Mut	r	26276	30.06.98	ws	gepr./CHECKED BY Sa		Marquardt GmbH, D-78604 Rietheim-Weilheim	
v	38995	13.04.04	wj	q	25574	24.11.97	ws	Ersatz für/REPLACEMENT OF 6450.0001 v.16.08.77		RELEASED/FREIGEgeben 2008/May/27	
u	39258	10.12.03	wj								
t	38683	30.10.03	wj	y	58349	20.05.08	BRC				
Ausg. ISSUE	Aenderung REVISION	gez. DRAWN BY		Ausg. ISSUE	Aenderung REVISION	gez. DRAWN BY					

Mouser Electronics

Authorized Distributor

Click to View Pricing, Inventory, Delivery & Lifecycle Information:

[Marquardt:](#)

[06450.0295-00](#)