

# Digital Ambient Light Sensor and Proximity Sensor with Interrupt Function

## ISL29018

The ISL29018 is an integrated ambient and infrared light to digital converter with a built-in IR LED driver and I<sup>2</sup>C Interface (SMBus Compatible). This device provides not only ambient light sensing to allow robust backlight/display brightness control but also infrared sensing to allow proximity estimation featured with interrupt function.

For ambient light sensing, an internal ADC has been designed based on the charge-balancing A/D conversion technique. The ADC conversion time is nominally 90ms and is user adjustable from 11 $\mu$ s to 90ms, depending on oscillator frequency and ADC resolution. This ADC is capable of rejecting 50Hz and 60Hz flicker noise caused by artificial light sources. The lux-range-select feature allows users to program the lux range for optimized counts/lux.

For proximity sensing, the ADC is used to digitize the output signal from the photodiode array when the internal IR LED driver is turned on and off for the programmed time periods under user-selected modulation frequency to drive the external IR LED. As this proximity sensor employs a noise cancellation scheme to highly reject unwanted IR noise, the digital output of proximity sensing decreases with distance. The driver output current is user selectable up to 100mA to drive different types of IR emitters LEDs.

Six different modes of operation can be selected via the I<sup>2</sup>C interface: Programmable ALS once with auto power-down, programmable IR sensing once, programmable proximity sensing once, programmable continuous ALS sensing, programmable continuous IR sensing and programmable continuous proximity sensing. The programmable one-time operation modes greatly reduce power because an immediate automatic shutdown reduces overall supply current less than 0.5 $\mu$ A.

The ISL29018 supports both hardware and software interrupts that remain asserted until the host clears it through I<sup>2</sup>C interface for ambient light sensing and proximity detection.

Designed to operate on supplies from 2.25V to 3.63V, the ISL29018 is specified for operation over the -40°C to +85°C ambient temperature range. It is packaged in a clear, Pb-free 8 Ld ODFN package.

## Applications

- Display and Keypad Dimming Adjustment and Proximity Sensing for:
  - Mobile Devices: Smart Phone, PDA, GPS
  - Computing Devices: Notebook PC, Webpad
  - Consumer Devices: LCD-TV, Digital Picture Frame, Digital Camera
- Industrial and Medical Light and Proximity Sensing

## Features

### Proximity Sensing

- Ambient IR Cancellation During Proximity Sensing
  - Works Under Direct Sunlight
- IR LED Driver with Programmable Source Current
  - Adjustable Current Drive from 100mA to 12.5mA
- Programmable LED current Modulation Frequency
- Variable Conversion Resolution

### Ambient Light Sensing

- Simple Output Code Directly Proportional to lux
- Adjustable Sensitivity up to 65 Counts per lux
- Selectable Range (via I<sup>2</sup>C)
  - Range 1 = 0.015 lux to 1,000 lux
  - Range 2 = 0.06 lux to 4,000 lux
  - Range 3 = 0.24 lux to 16,000 lux
  - Range 4 = 0.96 lux to 64,000 lux
- Integrated 50/60Hz Noise Rejection
- Works Under Various Light Sources, Including Sunlight

### Ideal Spectral Response for Light and Proximity Sensor

- Light Sensor Close to Human Eye Response
  - Excellent Light Sensor IR and UV Rejection
- Proximity sensor range from 850nm to 950nm
  - Can use either 850nm or 950nm LED solution

### Ultra Low Power

- 90 $\mu$ A Max Operating Current
- Software Shutdown and Automatic Shutdown
  - 0.5 $\mu$ A Max Shutdown Current

### Easy to Use

- I<sup>2</sup>C (SMBus Compatible) Output
- No Complex Algorithms Needed
- Temperature Compensated
- Small Form Factor
  - 8 Ld 2.0mmx2.1mmx0.7mm ODFN Package

### Additional Features

- I<sup>2</sup>C and SMBus Compatible
- 1.7V to 3.63V Supply for I<sup>2</sup>C Interface
- 2.25V to 3.63V Sensor Power Supply
- Pb-Free (RoHS compliant)

# ISL29018

## Ordering Information

| PART NUMBER<br>(Notes 1, 2, 3) | TEMP. RANGE<br>(°C) | PACKAGE<br>Tape and Reel<br>(Pb-Free) | PKG.<br>DWG. # |
|--------------------------------|---------------------|---------------------------------------|----------------|
| ISL29018IROZ-T7                | -40 to +85          | 8 Ld ODFN                             | L8.3x3F        |
| ISL29011IROZ-EVALZ             | Evaluation Board    |                                       |                |

### NOTES:

- Please refer to [TB347](#) for details on reel specifications.
- These Intersil Pb-free plastic packaged products employ special Pb-free material sets; molding compounds/die attach materials and NiPdAu plate - e4 termination finish, which is RoHS compliant and compatible with both SnPb and Pb-free soldering operations. Intersil Pb-free products are MSL classified at Pb-free peak reflow temperatures that meet or exceed the Pb-free requirements of IPC/JEDEC J STD-020.
- For Moisture Sensitivity Level (MSL), please see device information page for [ISL29018](#). For more information on MSL please see techbrief [TB477](#).

## Pin Configuration

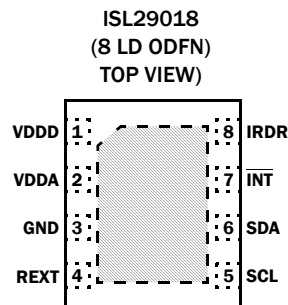

## Pin Descriptions

| PIN NUMBER | PIN NAME                | DESCRIPTION   |  |
|------------|-------------------------|---|--|
| 1          | VDDD                    | Positive digital supply: 2.25V to 3.63V.  |  |
| 2          | VDDA                    | Positive analog supply: 2.25V to 3.63V, VDDA and VDDD should be externally shorted.   |  |
| 3          | GND                     | Ground. The thermal pad is also connected to the GND pin.   |  |
| 4          | REXT                    | External resistor pin setting the internal reference current and the conversion time. 499kΩ with 1% tolerance resistor is recommended.                |  |
| 5          | SCL                     | I <sup>2</sup> C serial clock line  | The I <sup>2</sup> C bus lines can be pulled from 1.7V to above V <sub>DD</sub> , 3.63V max. |
| 6          | SDA                     | I <sup>2</sup> C serial data line   |  |
| 7          | $\overline{\text{INT}}$ | Interrupt pin; LO for interrupt/alarms. The $\overline{\text{INT}}$ pin is an open drain.   |  |
| 8          | IRDR                    | IR LED driver pin connecting to the anode of the external IR LED. The source current of the IR LED driver can be programmed through I <sup>2</sup> C. |  |
|            |                         | Exposed pad connected to ground or electrically isolated.   |  |

# ISL29018

## Block Diagram

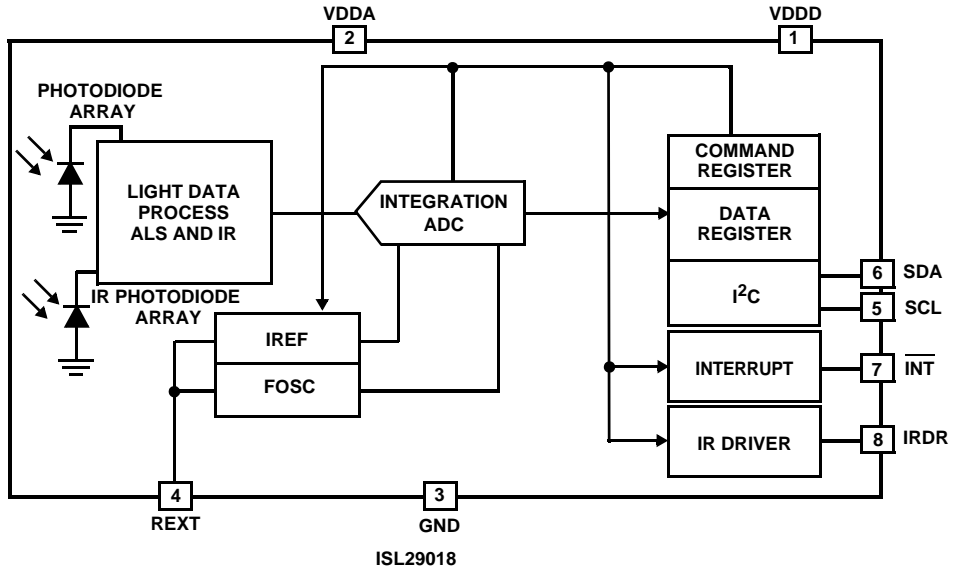

# ISL29018

## Absolute Maximum Ratings (T<sub>A</sub> = +25°C)

|   |                                 |
|---|---------------------------------|
| V <sub>SUP</sub> (V <sub>DDD</sub> ,V <sub>DDA</sub> ) Supply Voltage between V <sub>DD</sub> and GND | 4V                              |
| V <sub>DDA</sub> Supply Voltage between V <sub>DDA</sub> and GND                                      | V <sub>DDD</sub> ± 0.5V         |
| I <sup>2</sup> C Bus (SCL, SDA) and I <sup>2</sup> T Pin Voltage                                      | -0.2V to 4V                     |
| I <sup>2</sup> C Bus (SCL, SDA) and I <sup>2</sup> T Pin Current                                      | <10mA                           |
| IRDR Pin Voltage  | -0.2V to V <sub>DD</sub> + 0.5V |
| R <sub>EXT</sub> Pin Voltage  | -0.2V to V <sub>DD</sub> + 0.5V |
| ESD Rating  |                                 |
| Human Body Model  | 2kV                             |

## Thermal Information

|                                      |                        |
|--------------------------------------|------------------------|
| Thermal Resistance (Typical, Note 4) | θ <sub>JA</sub> (°C/W) |
| 8 Ld ODFN                            | 62                     |
| Maximum Die Temperature              | +90°C                  |
| Storage Temperature                  | -40°C to +100°C        |
| Operating Temperature                | -40°C to +85°C         |

CAUTION: Do not operate at or near the maximum ratings listed for extended periods of time. Exposure to such conditions may adversely impact product reliability and result in failures not covered by warranty.

### NOTE:

- θ<sub>JA</sub> is measured in free air with the component mounted on a high effective thermal conductivity test board with “direct attach” features. See Tech Brief [TB379](#).

IMPORTANT NOTE: All parameters having Min/Max specifications are guaranteed. Typical values are for information purposes only. Unless otherwise noted, all tests are at the specified temperature and are pulsed tests, therefore: T<sub>J</sub> = T<sub>C</sub> = T<sub>A</sub>

## Electrical Specifications V<sub>SUP</sub>(V<sub>DDD</sub>,V<sub>DDA</sub>) = 3V, T<sub>A</sub> = +25°C, R<sub>EXT</sub> = 499kΩ 1% tolerance, 16-bit ADC operation, unless otherwise specified.

| PARAMETER                   | DESCRIPTION   | CONDITION   | MIN (Note 9) | TYP      | MAX (Note 9) | UNIT   |
|-----------------------------|---|---|--------------|----------|--------------|--------|
| V <sub>SUP</sub>            | Power Supply Range for V <sub>DDD</sub> , V <sub>DDA</sub>                              | (Note 5)  | 2.25         |          | 3.63         | V      |
| SR_V <sub>DD</sub>          | Required Input Power-up Slew Rate   | V <sub>DD</sub> rising edge between 0.4V and 2.25V                                |              | 0.5      |              | V/ms   |
| I <sub>SUP(OFF)</sub>       | Supply Current when Powered Down  | Software disabled or auto power-down  |              | 0.1      | 0.5          | µA     |
| I <sub>SUP(ON)</sub>        | Supply Current of Ambient Light and IR Sensing  |   |              | 70       | 90           | µA     |
| f <sub>OSC</sub>            | Internal Oscillator Frequency   |   | 675          | 750      | 825          | kHz    |
| t <sub>int</sub>            | ADC Integration/Conversion Time   | 16-bit ADC data   |              | 90       |              | ms     |
| F <sub>I<sup>2</sup>C</sub> | I <sup>2</sup> C Clock Rate Range   |   |              | 1 to 400 |              | kHz    |
| DATA_0                      | Count Output When Dark  | E = 0 lux   |              | 1        | 5            | Counts |
| DATA_FS                     | Full Scale ADC Code   |   |              |          | 65535        | Counts |
| ΔDATA<br>DATA               | Count Output Variation Over Three Light Sources: Fluorescent, Incandescent and Sunlight | Ambient light sensing   |              | ±10      |              | %      |
| DATA_1                      | Light Count Output With LSB of 0.015 lux/count  | E = 300 lux, Fluorescent light (Note 6), Ambient light sensing, Range 1 (1k lux)  | 15000        | 20000    | 25000        | Counts |
| DATA_2                      | Light Count Output With LSB of 0.06 lux/count   | E = 300 lux, Fluorescent light (Note 6), Ambient light sensing, Range 2 (4k lux)  |              | 5000     |              | Counts |
| DATA_3                      | Light Count Output With LSB of 0.24 lux/count   | E = 300 lux, Fluorescent light (Note 6), Ambient light sensing, Range 3 (16k lux) |              | 1250     |              | Counts |
| DATA_4                      | Light Count Output With LSB of 0.96 lux/count   | E = 300 lux, Fluorescent light (Note 6), Ambient light sensing, Range 4 (64k lux) |              | 312      |              | Counts |
| DATA_IR1                    | Infrared Count Output   | E = 210 lux, Sunlight (Note 7), IR sensing, Range 1                               | 15000        | 20000    | 25000        | Counts |
| DATA_IR2                    | Infrared Count Output   | E = 210 lux, Sunlight (Note 7), IR sensing, Range 2                               |              | 5000     |              | Counts |
| DATA_IR3                    | Infrared Count Output   | E = 210 lux, Sunlight (Note 7), IR sensing, Range 3                               |              | 1250     |              | Counts |
| DATA_IR4                    | Infrared Count Output   | E = 210 lux, Sunlight (Note 7), IR sensing, Range 4                               |              | 312      |              | Counts |

# ISL29018

**Electrical Specifications**  $V_{SUP}(V_{DDD}, V_{DDA}) = 3V$ ,  $T_A = +25^\circ C$ ,  $R_{EXT} = 499k\Omega$  1% tolerance, 16-bit ADC operation, unless otherwise specified. (Continued)

| PARAMETER          | DESCRIPTION   | CONDITION  | MIN (Note 9)            | TYP            | MAX (Note 9) | UNIT |    |
|--------------------|---|--|-------------------------|----------------|--------------|------|----|
| $V_{REF}$          | Voltage of $R_{EXT}$ Pin  |  |                         | 0.52           |              | V    |    |
| $I_{INT}$          | $\overline{INT}$ Current Sinking Capability   |  | 4                       | 5              |              | mA   |    |
| $I_{IRDR1}$        | IRDR Source Current   | $IS<1:0> = 0$<br>(Note 8)  | 15 $\Omega$ at IRDR pin |                |              | 100  | mA |
| $I_{IRDR2}$        | IRDR Source Current   | $IS<1:0> = 1$<br>(Note 8)  |                         | 44             | 50           | 58   | mA |
| $I_{IRDR3}$        | IRDR Source Current   | $IS<1:0> = 2$<br>(Note 8)  |                         |                | 25           |      | mA |
| $I_{IRDR4}$        | IRDR Source Current   | $IS<1:0> = 3$<br>(Note 8)  |                         |                | 12.5         |      | mA |
| $V_{IRLED}$        | Voltage Head Room of IRDR Pin   | IRDR = 90mA, $IS<1:0> = 0$ (Note 8)  |                         | $V_{DD} - 1.0$ |              | V    |    |
| $t_r$              | Rise Time for IRDR Source Current   | $R_{LOAD} = 15\Omega$ at IRDR pin, 20% to 80%  |                         | 35             |              | ns   |    |
| $t_f$              | Fall Time for IRDR Source Current   | $R_{LOAD} = 15\Omega$ at IRDR pin, 80% to 20%  |                         | 10             |              | ns   |    |
| $f_{IRLED1}$       | IR LED Modulation Frequency   | Freq = 0 (Note 8)  |                         | DC             |              | kHz  |    |
| $f_{IRLED2}$       | IR LED Modulation Frequency   | Freq = 1 (Note 8)  |                         | 360            |              | kHz  |    |
| $I_{SUP} (IRLED1)$ | Supply Current of Proximity Sensing   | $IS<1:0> = 0$ , Freq = 0 (Note 8)  |                         | 101            |              | mA   |    |
| $I_{SUP} (IRLED2)$ | Supply Current of Proximity Sensing   | $IS<1:0> = 0$ , Freq = 1 (Note 8)  |                         | 51             |              | mA   |    |
| Duty Cycle         | Duty Cycle of IR LED Modulation   |  |                         | 50             |              | %    |    |
| PROX-IR<br>PROX    | Differential ADC Output of IR and Proximity Sensing With Object Far Away to Provide No Reflection | IR and proximity sensing with Range 2 and Scheme 0; 15 $\Omega$ @ IRDR pin, $IS<1:0> = 0$ , Freq = 0; E = 210 lux, Sunlight. |                         | 1.0            |              | %    |    |

**NOTES:**

- $V_{SUP}$  is the common voltage to  $V_{DDD}$  and  $V_{DDA}$ .
- 550nm green LED is used in production test. The 550nm LED irradiance is calibrated to produce the same DATA count against an illuminance level of 300 lux fluorescent light.
- 850nm infrared LED is used in production test. The 850nm LED irradiance is calibrated to produce the same DATA\_IR count against an illuminance level of 210 lux sunlight at sea level.
- See "Register Set" on page 10.

**I<sup>2</sup>C Interface Specifications** For SCL and SDA unless otherwise noted,  $V_{SUP}(V_{DDD}, V_{DDA}) = 3V$ ,  $T_A = +25^\circ C$ ,  $R_{EXT} = 499k\Omega$  1% tolerance, 16-bit ADC operation.

| PARAMETER  | DESCRIPTION   | CONDITION | MIN (Note 9)  | TYP | MAX (Note 9) | UNIT    |
|------------|---|-----------|---------------|-----|--------------|---------|
| $V_{I^2C}$ | Supply Voltage Range for I <sup>2</sup> C Interface               |           | 1.7           |     | 3.63         | V       |
| $f_{SCL}$  | SCL Clock Frequency   |           |               |     | 400          | kHz     |
| $V_{IL}$   | SCL and SDA Input Low Voltage                                     |           |               |     | 0.55         | V       |
| $V_{IH}$   | SCL and SDA Input High Voltage                                    |           | 1.25          |     |              | V       |
| $V_{hys}$  | Hysteresis of Schmitt Trigger Input                               |           | 0.05 $V_{DD}$ |     |              | V       |
| $V_{OL}$   | Low-level output voltage (open-drain) at 4mA sink current         |           |               |     | 0.4          | V       |
| $I_i$      | Input Leakage for each SDA, SCL pin                               |           | -10           |     | 10           | $\mu A$ |
| $t_{SP}$   | Pulse width of spikes that must be suppressed by the input filter |           |               |     | 50           | ns      |

# ISL29018

**I<sup>2</sup>C Interface Specifications** For SCL and SDA unless otherwise noted,  $V_{SUP}(V_{DD},V_{DDA}) = 3V$ ,  $T_A = +25^\circ C$ ,  $R_{EXT} = 499k\Omega$  1% tolerance, 16-bit ADC operation. (Continued)

| PARAMETER     | DESCRIPTION                                      | CONDITION  | MIN (Note 9)               | TYP | MAX (Note 9) | UNIT       |
|---------------|--|--|----------------------------|-----|--------------|------------|
| $t_{AA}$      | SCL Falling Edge to SDA Output Data Valid        |  |                            |     | 900          | ns         |
| $C_i$         | Capacitance for each SDA and SCL pin             |  |                            |     | 10           | pF         |
| $t_{HD:STA}$  | Hold Time (Repeated) START Condition             | After this period, the first clock pulse is generated. | 600                        |     |              | ns         |
| $t_{LOW}$     | LOW Period of the SCL clock                      | Measured at the 30% of VDD crossing.                   | 1300                       |     |              | ns         |
| $t_{HIGH}$    | HIGH period of the SCL Clock                     |  | 600                        |     |              | ns         |
| $t_{SU:STA}$  | Set-up Time for a Repeated START Condition       |  | 600                        |     |              | ns         |
| $t_{HD:DAT}$  | Data Hold Time                                   |  | 30                         |     |              | ns         |
| $t_{SU:DAT}$  | Data Set-up Time                                 |  | 100                        |     |              | ns         |
| $t_R$         | Rise Time of both SDA and SCL Signals            |  | 20 +<br>0.1xC <sub>b</sub> |     |              | ns         |
| $t_F$         | Fall Time of both SDA and SCL Signals            |  | 20 +<br>0.1xC <sub>b</sub> |     |              | ns         |
| $t_{SU:STO}$  | Set-up Time for STOP Condition                   |  | 600                        |     |              | ns         |
| $t_{BUF}$     | Bus Free Time Between a STOP and START Condition |  | 1300                       |     |              | ns         |
| $C_b$         | Capacitive Load for Each Bus Line                |  |                            |     | 400          | pF         |
| $R_{pull-up}$ | SDA and SCL system bus pull-up resistor          | Maximum is determined by $t_R$ and $t_F$               | 1                          |     |              | k $\Omega$ |
| $t_{VD:DAT}$  | Data Valid Time                                  |  |                            |     | 0.9          | $\mu s$    |
| $t_{VD:ACK}$  | Data Valid Acknowledge Time                      |  |                            |     | 0.9          | $\mu s$    |
| $V_{nL}$      | Noise Margin at the LOW Level                    |  | 0.1VDD                     |     |              | V          |
| $V_{nH}$      | Noise Margin at the HIGH Level                   |  | 0.2VDD                     |     |              | V          |

**NOTE:**

9. Compliance to datasheet limits is assured by one or more methods: production test, characterization and/or design.

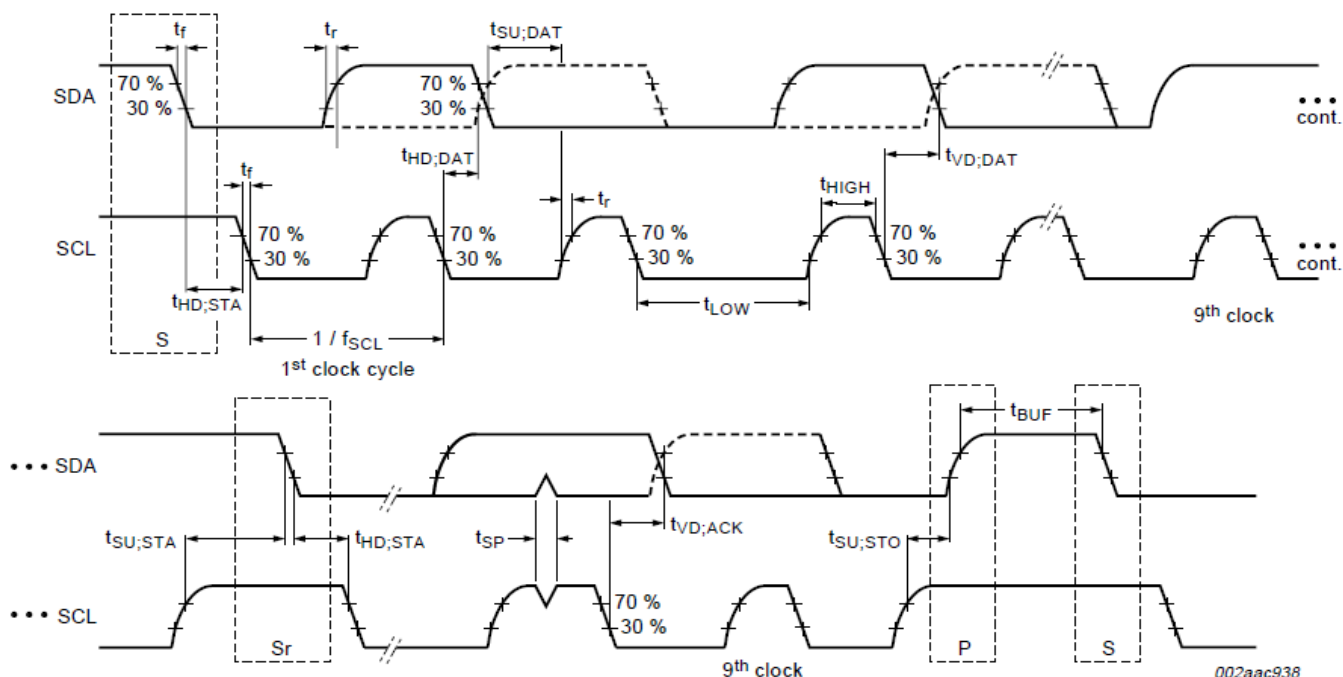

FIGURE 1. I<sup>2</sup>C TIMING DIAGRAM

## Principles of Operation

### Photodiodes and ADC

The ISL29018 contains two photodiode arrays which convert light into current. The spectral response for ambient light sensing and IR sensing is shown in Figure 8 in the performance curves section. After light is converted to current during the light signal process, the current output is converted to digital by a built-in 16-bit Analog-to-Digital Converter (ADC). An I<sup>2</sup>C command reads the ambient light or IR intensity in counts.

The converter is a charge-balancing integrating type 16-bit ADC. The chosen method for conversion is best for converting small current signals in the presence of an AC periodic noise. A 100ms integration time, for instance, highly rejects 50Hz and 60Hz power line noise simultaneously. See “Integration and Conversion Time” on page 12.

The built-in ADC offers user flexibility in integration time or conversion time. Integration time is determined by an internal oscillator ( $f_{OSC}$ ), and the n-bit ( $n = 4, 8, 12, 16$ ) counter inside the ADC. A good balancing act of integration time and resolution depending on the application is required for optimal results.

The ADC has I<sup>2</sup>C programmable range select to dynamically accommodate various lighting conditions. For very dim conditions, the ADC can be configured at its lowest range (Range 1) in the ambient light sensing. For very bright conditions, the ADC can be configured at its highest range (Range 4) in the proximity sensing.

### Low-Power Operation

The ISL29018 initial operation is at the power-down mode after a supply voltage is provided. The data registers contain the default value of 0. When the ISL29018 receives an I<sup>2</sup>C command to do a one-time measurement from an I<sup>2</sup>C master, it will start ADC conversion with light or proximity sensing. It will go to the power-

down mode automatically after one conversion is finished and keep the conversion data available for the master to fetch anytime afterwards. The ISL29018 will continuously do ADC conversion with light or proximity sensing if it receives an I<sup>2</sup>C command of continuous measurement. It will continuously update the data registers with the latest conversion data. It will go to the power-down mode after it receives the I<sup>2</sup>C command of power-down.

### Ambient Light, IR and Proximity Sensing

There are six operational modes in ISL29018: Programmable ALS once with auto power-down, programmable IR sensing once with auto power-down, programmable proximity sensing once with auto power-down; programmable continuous ALS sensing, programmable continuous IR sensing and programmable continuous proximity sensing. These six modes can be programmed in series to fulfill the application needs. The detailed program configuration is listed in “Register Set” on page 10.

When the part is programmed for ambient light sensing, the ambient light with wavelength within the “Ambient Light Sensing” spectral response curve in Figure 8 is converted into current. With ADC, the current is converted to an unsigned n-bit (up to 16 bits) digital output.

When the part is programmed for infrared (IR) sensing, the IR light with wavelength within the “IR or Proximity Sensing” spectral response curve on Figure 8 is converted into current. With ADC, the current is converted to an unsigned n-bit (up to 16 bits) digital output.

When the part is programmed for proximity sensing, the external IR LED is turned on by the built-in IR LED driver through the IRDR pin. The amplitude of the IR LED current and the IR LED modulation frequency can be programmed through Command Register II. When the IR from the LED reaches an object and gets reflected back, the reflected IR light with wavelength within the “IR or Proximity Sensing” spectral response curve in Figure 8 is

converted into current. With ADC, the current is converted to an unsigned n-bit (up to 16 bits) digital output. The output reading is inversely proportional to the square of the distance between the sensor and the object.

## Interrupt Function

The active low interrupt pin is an open drain pull-down configuration. There is also an interrupt bit in the I<sup>2</sup>C register. The interrupt serves as an alarm or monitoring function to determine whether the ambient light level or the proximity detection level exceeds the upper threshold or goes below the lower threshold. The user can also configure the persistency of the interrupt. This reduces the possibility of false triggers, such as noise or sudden spikes in ambient light conditions. An unexpected camera flash,

Example:

State 0: Ambient light

Operation Mode = ALS continuous  
 Interrupt Persist = 1  
 Resolution = 16 bits  
 Range = 1000 Lux  
 Scheme, Frequency & IRDR = X (DONT CARE)  
 Threshold High = 100 Lux  
 Threshold Low = 10 Lux  
 Command1 = 101x xx00  
 Command2 = xxx 0000  
 Hi Threshold = 655  
 Lo Threshold = 66

State 1: Proximity - interrupt when NEAR

Operation Mode = Proximity continuous  
 Interrupt Persist = 4  
 Resolution = 12 bits  
 Range = 1  
 Scheme = 1  
 Frequency = 0  
 IRDR = 100ma  
 Threshold High = NEAR  
 Threshold Low = OFF  
 Command1 = 111x xx01  
 Command2 = 1011 0100  
 Hi Threshold = 1535 (75% of 2047)  
 Lo Threshold = -2048 (OFF)

Sequence State 0 -> State 1

**Command** = {Range, Resolution, IRDR, Scheme, Frequency & Persist}

for example, can be ignored by setting the persistency to 8 integration cycles.

## Changing States - Avoiding Unintentional Interrupts

A common application for the ISL29018 is alternating between ambient light and proximity measurements. The two states have different command words and threshold settings. To avoid an unintentional interrupt the device should be powered down before the state change. The conversion should not be enabled until the new command word & thresholds have been set. A safe sequence is to set the operation mode to power-down, set the command word and thresholds to the new state, then set the operation mode to desired setting.

Off:

Write Byte Command1 = 0

State 1 setup:

Write Word (Command 1&2) = B401h

Write Word (Hi Threshold) = 05FFh

Write Word (Lo Threshold) = F800h

On:

Write Byte Command1 = E1h

Sequence State 1 -> State 0

Off:

Write Byte Command1 = 0

State 0 setup:

Write Word (Command 1&2) = B000h

Write Word (Hi Threshold) = 028Fh

Write Word (Lo Threshold) = 0042h

On:

Write Byte Command1 = A0h

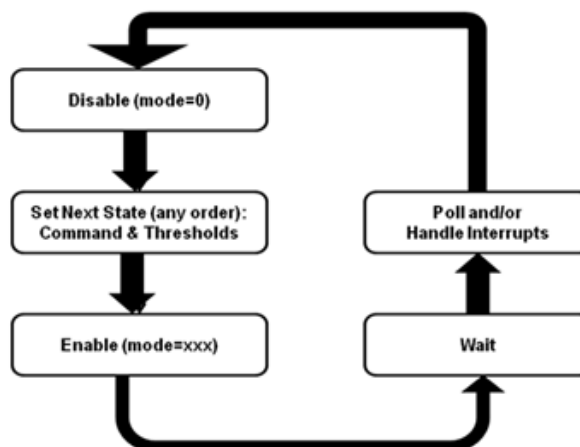

FIGURE 2. CHANGING STATES FLOW EXAMPLE



## I<sup>2</sup>C Interface

There are eight 8-bit registers available inside the ISL29018. The two command registers define the operation of the device. The command registers do not change until the registers are overwritten. The two 8-bit data Read Only registers are for the ADC output and the Timer output. The data registers contain the ADC's latest digital output. The four 8-bit interrupt registers hold 16-bit interrupt high and low thresholds.

The ISL29018's I<sup>2</sup>C interface slave address is internally hard-wired as 1000100. When 1000100x with x as R or  $\bar{W}$  is sent after the Start condition, this device compares the first seven bits of this byte to its address and matches.

Figure 3 shows a sample one-byte read. Figure 4 shows a sample one-byte write. The I<sup>2</sup>C bus master always drives the SCL (clock) line, while either the master or the slave can drive the SDA (data) line. Figure 4 shows a sample write. Every I<sup>2</sup>C transaction begins with the master asserting a start condition (SDA falling while SCL remains high). The following byte is driven by the master, and includes the slave address and read/write bit. The receiving device is responsible for pulling SDA low during the acknowledgement period. Every I<sup>2</sup>C transaction ends with the master asserting a stop condition (SDA rising while SCL remains high).

For more information about the I<sup>2</sup>C standard, please consult the Philips™ I<sup>2</sup>C specification documents.

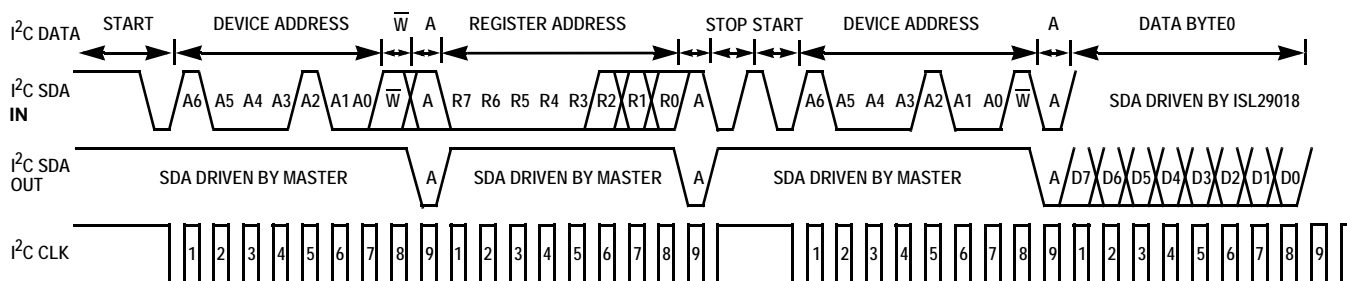

FIGURE 3. I<sup>2</sup>C READ TIMING DIAGRAM SAMPLE

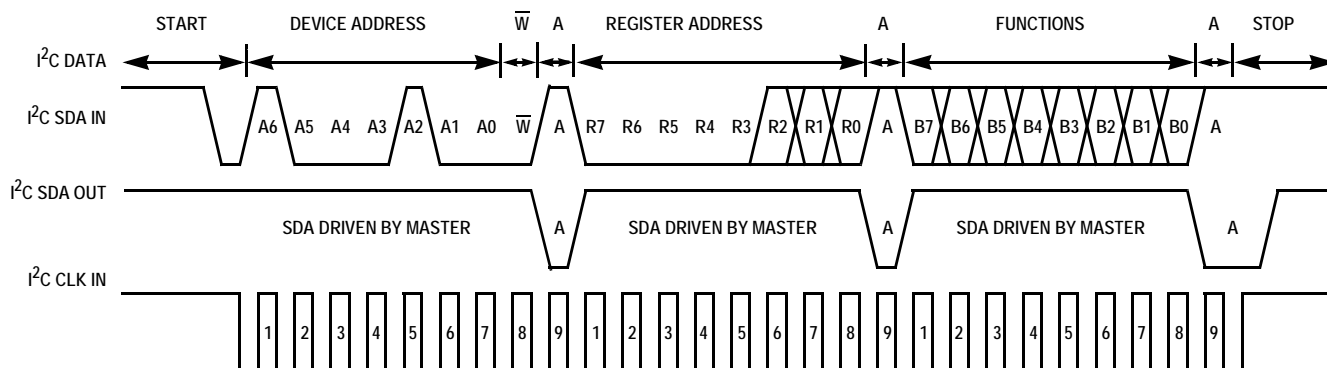

FIGURE 4. I<sup>2</sup>C WRITE TIMING DIAGRAM SAMPLE

# ISL29018

## Register Set

There are eight registers that are available in the ISL29018. Table 1 summarizes their functions.

TABLE 1. REGISTER SET

| ADDR | REG NAME            | BIT    |      |      |      |      |      |        |        | DEFAULT |
|------|---------------------|--------|------|------|------|------|------|--------|--------|---------|
|      |                     | 7      | 6    | 5    | 4    | 3    | 2    | 1      | 0      |         |
| 00h  | COMMANDI            | OP2    | OP1  | OP0  | 0    | 0    | FLAG | PRST1  | PRST0  | 00h     |
| 01h  | COMMANDII           | Scheme | FREQ | IS1  | IS0  | RES1 | RES0 | RANGE1 | RANGE0 | 00h     |
| 02h  | DATA <sub>LSB</sub> | D7     | D6   | D5   | D4   | D3   | D2   | D1     | D0     | 00h     |
| 03h  | DATA <sub>MSB</sub> | D15    | D14  | D13  | D12  | D11  | D10  | D9     | D8     | 00h     |
| 04h  | INT_LT_LSB          | TL7    | TL6  | TL5  | TL4  | TL3  | TL2  | TL1    | TL0    | 00h     |
| 05h  | INT_LT_MSB          | TL15   | TL14 | TL13 | TL12 | TL11 | TL10 | TL9    | TL8    | 00h     |
| 06h  | INT_HT_LSB          | TH7    | TH6  | TH5  | TH4  | TH3  | TH2  | TH1    | TH0    | FFh     |
| 07h  | INT_HT_MSB          | TH15   | TH14 | TH13 | TH12 | TH11 | TH10 | TH9    | TH8    | FFh     |
| 08h  | TEST                | 0      | 0    | 0    | 0    | 0    | 0    | 0      | 0      | 00h     |

## Command Register I 00(hex)

The first command register has the following functions:

1. Operation Mode: Bits 7, 6, and 5. These three bits determine the operation mode of the device.

**TABLE 2. OPERATION MODE**

| BITS 7 TO 5 | OPERATION             |
|-------------|-----------------------|
| 000         | Power-down the device |
| 001         | ALS once              |
| 010         | IR once               |
| 011         | Proximity once        |
| 100         | Reserved (Do not use) |
| 101         | ALS continuous        |
| 110         | IR continuous         |
| 111         | Proximity continuous  |

2. Interrupt flag; Bit 2. This is the status bit of the interrupt. The bit is set to logic high when the interrupt thresholds have been triggered, and logic low when not yet triggered. Once triggered, INT pin stays low and the status bit stays high. Both interrupt pin and the status bit are automatically cleared at the end of Command Register I transfer.

**TABLE 3. INTERRUPT FLAG**

| BIT 2 | OPERATION                                 |
|-------|---|
| 0     | Interrupt is cleared or not triggered yet |
| 1     | Interrupt is triggered                    |

3. Interrupt persist; Bits 1 and 0. The interrupt pin and the interrupt flag is triggered/set when the data sensor reading is out of the interrupt threshold window after m consecutive number of integration cycles. The interrupt persist bits determine m.

**TABLE 4. INTERRUPT PERSIST**

| BITS 1 TO 0 | NUMBER OF INTEGRATION CYCLES |
|-------------|------------------------------|
| 00          | 1                            |
| 01          | 4                            |
| 10          | 8                            |
| 11          | 16                           |

## Command Register II 01(hex)

The second command register has the following functions:

1. Proximity Sensing Scheme: Bit 7. This bit programs the function of the proximity detection. Logic 0 of this bit, Scheme 0, makes full n (4, 8, 12, 16) bits (unsigned) proximity detection. The range of Scheme 0 proximity count is from 0 to  $2^n$ . Logic 1 of this bit, Scheme 1, makes n-1 (3, 7, 11, 15) bits (2's complementary) proximity\_less\_ambient detection. The range of Scheme 1 proximity count is from  $-2^{(n-1)}$  to  $2^{(n-1)}$ . The sign bit is extended for resolutions less than 16. While Scheme 0 has wider dynamic

range, Scheme 1 proximity detection is less affected by the ambient IR noise variation.

**TABLE 5. PROXIMITY SENSING SCHEME**

| BIT 7 | OPERATION                                     |
|-------|---|
| 0     | Sensing IR from LED and ambient               |
| 1     | Sensing IR from LED with ambient IR rejection |

2. Modulation Frequency: Bits 6. This bit sets the IR LED driver's modulation frequency.

**TABLE 6. MODULATION FREQUENCY**

| BITS 6 | MODULATION FREQUENCY (kHz) |
|--------|----------------------------|
| 0      | DC                         |
| 1      | 360                        |

3. Amplitude of IR driver current: Bits 5 and 4. This device provides current source to drive an external IR LED. The drive capability can be programmed through Bits 5 and 4. For example, the device sources 12.5mA out of the IRDR pin if Bits 5 and 4 are 0.

**TABLE 7. CURRENT SOURCE CAPABILITY AT IRDR PIN**

| BITS 5 TO 4 | IRDR PIN SOURCE CURRENT |
|-------------|-------------------------|
| 00          | 12.5mA IR LED driver    |
| 01          | 25mA IR LED driver      |
| 10          | 50mA IR LED driver      |
| 11          | 100mA IR LED driver     |

4. Resolution: Bits 3 and 2. Bits 3 and 2 determine the ADC's resolution and the number of clock cycles per conversion in Internal Timing Mode. Changing the number of clock cycles does more than just change the resolution of the device. It also changes the integration time, which is the period the device's analog-to-digital (A/D) converter samples the photodiode current signal for a measurement.

**TABLE 8. RESOLUTION/WIDTH**

| BITS 3 TO 2 | NUMBER OF CLOCK CYCLES | n-BIT ADC |
|-------------|------------------------|-----------|
| 00          | $2^{16} = 65,536$      | 16        |
| 01          | $2^{12} = 4,096$       | 12        |
| 10          | $2^8 = 256$            | 8         |
| 11          | $2^4 = 16$             | 4         |

5. Range: Bits 1 and 0. The Full Scale Range (FSR) can be adjusted via I<sup>2</sup>C using Bits 1 and 0. Table 9 lists the possible values of FSR for the 499kΩ R<sub>EXT</sub> resistor.

**TABLE 9. RANGE/FSR LUX**

| BITS 1:0 | k | RANGE(k) | FSR (LUX) @ ALS SENSING | FSR @ IR SENSING |
|----------|---|----------|-------------------------|------------------|
| 00       | 1 | Range1   | 1,000                   | Refer to page 4  |
| 01       | 2 | Range2   | 4,000                   | Refer to page 4  |
| 10       | 3 | Range3   | 16,000                  | Refer to page 4  |
| 11       | 4 | Range4   | 64,000                  | Refer to page 4  |

## Data Registers (02 hex and 03 hex)

The device has two 8-bit read-only registers to hold the data from LSB to MSB for ADC. The most significant bit (MSB) is accessed at 03 hex, and the least significant bit (LSB) is accessed at 02 hex. For 16-bit resolution, the data is from D0 to D15; for 12-bit resolution, the data is from D0 to D11; for 8-bit resolution, the data is from D0 to D7. The registers are refreshed after every conversion cycle.

**TABLE 10. DATA REGISTERS**

| ADDRESS (hex) | CONTENTS  |
|---------------|---|
| 02            | D0 is LSB for 4, 8, 12 or 16-bit resolution, D3 is MSB for 4-bit resolution, D7 is MSB for 8-bit resolution |
| 03            | D15 is MSB for 16-bit resolution, D11 is MSB for 12-bit resolution  |

## Interrupt Registers (04, 05, 06 and 07 hex)

Registers 04 and 05 hex set the low (LO) threshold for the interrupt pin and the interrupt flag. 04 hex is the LSB and 05 hex is the MSB. By default, the Interrupt threshold LO is 00 hex for both LSB and MSB.

Registers 06 and 07 hex set the high (HI) threshold for the interrupt pin and the interrupt flag. 06 hex is the LSB and 07 hex is the MSB. By default, the Interrupt threshold HI is FF hex for both LSB and MSB.

## Test Register (08 hex)

Register 8 is a reserved register that holds 00h during normal operation.

## Calculating Lux

The ISL29018's ADC output codes, DATA, are directly proportional to lux in the ambient light sensing.

$$E_{cal} = \alpha \times \text{DATA} \quad (\text{EQ. 1})$$

Here,  $E_{cal}$  is the calculated lux reading. The constant  $\alpha$  is determined by the Full Scale Range and the ADC's maximum output counts. The constant is independent on the light sources (fluorescent, incandescent and sunlight) because of the light sources' IR component is removed during the light signal process. The constant can also be viewed as the sensitivity: the smallest lux measurement the device can measure as shown in Equation 2.

$$\alpha = \frac{\text{Range}(k)}{\text{Count}_{max}} \quad (\text{EQ. 2})$$

Here, Range(k) is defined in Table 9.  $\text{Count}_{max}$  is the maximum output counts from the ADC.

The transfer function used for n-bit ADC becomes Equation 3:

$$E_{cal} = \frac{\text{Range}(k)}{2^n} \times \text{DATA} \quad (\text{EQ. 3})$$

Here,  $n = 4, 8, 12$  or  $16$ . This is the number of ADC bits programmed in the command register.  $2^n$  represents the maximum number of counts possible from the ADC output. Data is the ADC output stored in the data registers (02 hex and 03 hex).

## Integration and Conversion Time

The ADC resolution and  $f_{OSC}$  determines the integration time,  $t_{int}$  as shown in Equation 4.

$$t_{int} = 2^n \times \frac{1}{f_{OSC}} = 2^n \times \frac{R_{EXT}}{725\text{kHz} \times 499\text{k}\Omega} \quad (\text{EQ. 4})$$

where  $n$  is the number of bits of resolution and  $n = 4, 8, 12$  or  $16$ .  $2^n$ , therefore, is the number of clock cycles.  $n$  can be programmed at the command register 01(hex) bits 3 and 2.

**TABLE 11. INTEGRATION TIME OF n-BIT ADC**

| $R_{EXT}$ (k $\Omega$ ) | n = 16-BIT (ms) | n = 12-BIT (ms) | n = 8-BIT ( $\mu$ s) | n = 4-BIT ( $\mu$ s) |
|-------------------------|-----------------|-----------------|----------------------|----------------------|
| 499**                   | 90              | 5.63            | 351                  | 21.6 $\mu$ s         |

\*\*Recommended  $R_{EXT}$  resistor value

## External Scaling Resistor $R_{EXT}$ for $f_{OSC}$ and Range

The ISL29018 uses an external resistor  $R_{EXT}$  to fix its internal oscillator frequency,  $f_{OSC}$  and the light sensing range, Range.  $f_{OSC}$  and Range are inversely proportional to  $R_{EXT}$ . For user simplicity, the proportionality constant is referenced to 499k $\Omega$  as shown in Equations 5 and 6:

$$\text{Range} = \frac{499\text{k}\Omega}{R_{EXT}} \times \text{Range}(k) \quad (\text{EQ. 5})$$

$$f_{OSC} = \frac{499\text{k}\Omega}{R_{EXT}} \times 725\text{kHz} \quad (\text{EQ. 6})$$

## Noise Rejection

In general, integrating type ADC's have excellent noise-rejection characteristics for periodic noise sources whose frequency is an integer multiple of the conversion rate. For instance, a 60Hz AC unwanted signal's sum from 0ms to  $k^*16.66\text{ms}$  ( $k = 1, 2, \dots, k_i$ ) is zero. Similarly, setting the device's integration time to be an integer multiple of the periodic noise signal, greatly improves the light sensor output signal in the presence of noise.

## ADC Output in IR Sensing

The ISL29018's ADC output codes, DATA, are directly proportional to the IR intensity received in the IR sensing.

$$\text{DATA}_{IR} = \beta \times E_{IR} \quad (\text{EQ. 7})$$

Here,  $E_{IR}$  is the received IR intensity. The constant  $\beta$  changes with the spectrum of background IR noise like sunlight and

incandescent light. The  $\beta$  also changes with the ADC's range and resolution selections.

## ADC Output in Proximity Sensing

In the proximity sensing, the ADC output codes, DATA, are directly proportional to the total IR intensity from the background IR noise and from the IR LED driven by the ISL29018.

$$DATA_{PROX} = \beta \times E_{IR} + \gamma \times E_{LED} \quad (EQ. 8)$$

Here,  $\beta$  and  $E_{IR}$  have the same meanings as in Equation 7. The constant  $\gamma$  depends on the spectrum of the used IR LED and the ADC's range and resolution selections.  $E_{LED}$  is the IR intensity which is emitted from the IR LED and reflected by a specific object to the ISL29018.  $E_{LED}$  depends on the current to the IR LED and the surface of the object.  $E_{LED}$  decreases with the square of the distance between the object and the sensor.

If background IR noise is small,  $E_{IR}$  can be neglected, and the ADC output directly decreases with the distance. If there is significant background IR noise, ISL29018 offers two schemes to reduce the effect. The first way is do a proximity sensing using Scheme 0, immediately followed by an IR sensing. The differential reading of ADC outputs from the proximity and IR sensing will then reduce the effect of background IR noise and directly decrease with the distance between the object and the sensor. The second way is to do a proximity sensing using Scheme 1 to do on-chip background IR noise subtraction. While Scheme 0 has wider dynamic range, Scheme 1 proximity detection is faster but with half the resolution. Please refer to "Typical Performance Curves" on page 15 for ADC output versus distance using Scheme 0 detection.

Figure 11 shows ISL29018 configured at 12-bit ADC resolution and sensitivity range select at 16000 (range 3) for the proximity reading. A 12.5mA external LED current at 360kHz modulation frequency detects three different sensing objects: 92% brightness paper, 18% gray card and ESD black foam. Figure 12 shows ISL29018 configured at 12-bit ADC resolution and sensitivity range select at 1000 (range 1) for the proximity reading, with a programmed external LED at 360kHz modulation frequency, detecting the same sensing object: 18% gray card under four different external LED current: 12.5mA, 25mA, 50mA and 100mA to compare the proximity readout versus distance.

ISL29018 Proximity sensing relies on the amount of IR reflected back from the objects to be detected. Clearly, it can not detect an optically black object that reflects no light. However, ISL29018 is sensitive enough to detect a black ESD foam, which reflects slightly less than 1% of IR, as shown in Figure 11 on page 15. For biological objects, blonde hair reflects more than brunette hair, as expected and shown in Figure 13. Also notice that skin tissue is much more reflective than hair. IR penetrates into the skin and is reflected or scattered back from within. As a result, the proximity count peaks at contact and monotonically decreases as skin moves away. This characteristic is very different from that of a plain paper reflector.

## Interrupt Function

An interrupt event (FLAG) is governed by bit2 in COMMAND1. The user must set bit2 in COMMAND1 to be logic low(0), which means  $\overline{INT}$  is cleared or not triggered yet. Then ISL29018 will issue an

ambient (ALS/IR) or proximity interrupt flag if the actual count stored in Register 0x2 and 0x3 are outside the user's programmed window. The user must read Register 0x0 to clear interrupt.

Interrupt persistency at bit1 and bit0 of COMMAND1 is another useful option available for both ambient/IR and proximity measurement. Persistency requires x-in-a-row interrupt flags before the  $\overline{INT}$  pin is driven low. Then, user must read Register 0x0 to clear Interrupt.

## V<sub>DD</sub> Power-up and Power Supply Considerations

Upon power-up, please ensure a  $V_{DD}$  slew rate of 0.5V/ms or greater. After power-up, or if the user's power supply temporarily deviates from our specification (2.25V to 3.63V), Intersil recommends the user write 0x00 to two registers: 0x08, 0x00 (in that order), wait ~1ms or more and then rewrite all registers as desired.

## LED Modulation for Proximity Detection

ISL29018 offers two ways to modulate the LED in the Proximity Detection mode - DC or 360kHz (with 50% duty cycle) by bit 6 of register 01h. At the IRDR pin, there are four different IRDR LED currents; 12.5, 25, 50, and 100mA outputs selectable by bits 4 and 5 of register 01h. With the LED running in the DC mode, the proximity detection is twice as sensitive but consumes 2 times more current. The sensitivity of LED 50mA, DC 50mA is identical to that of 100mA, 360kHz modulation. Please note that the ISL29018 does not include a LED.

## Current Consumption Estimation

The low power operation is achieved through sequential readout in the serial fashion, as shown in Figure 5, the device requires three different phases in serial during the entire detection cycle to do ambient light sensing, infrared sensing and proximity sensing. The external IR LED will only be turned on during the proximity sensing phase under user program controlled current at modulated frequency depends on user selections. Figure 5 also shows the current consumption during each ALS, IR sensing and Proximity sensing phase. For example, at 8-bit ADC resolution the integration time is 0.4ms. If user programmed 50mA current to supply external IR LED at 360kHz modulated frequency, during the entire operation cycle that includes ALS, IR sensing and Proximity sensing three different serial phases, the detection occurs once every 30ms, the average current consumption including external IR LED drive current can be calculated from Equation 9:

$$[(0.07\text{mA} + 0.07\text{mA} + 1\text{mA} + (50\text{mA} \times 50\%)) \times 0.4\text{ms}] / 30\text{ms} = 0.35\text{mA} \quad (EQ. 9)$$

If at a 12-bit ADC resolution where the integration time for each serial phase becomes 7ms and the total detection time becomes 100ms, the average current can be calculated from Equation 10:

$$[(0.07\text{mA} + 0.07\text{mA} + 1\text{mA} + (50\text{mA} \times 50\%)) \times 7\text{ms}] / 100\text{ms} = 1.83\text{mA} \quad (EQ. 10)$$

## Suggested PCB Footprint

It is important that the users check the “Surface Mount Assembly Guidelines for Optical Dual FlatPack No Lead (ODFN) Package” before starting ODFN product board mounting.

<http://www.intersil.com/data/tb/TB477.pdf>

## Layout Considerations

The ISL29018 is relatively insensitive to layout. Like other I<sup>2</sup>C devices, it is intended to provide excellent performance even in significantly noisy environments. There are only a few considerations that will ensure best performance.

Route the supply and I<sup>2</sup>C traces as far as possible from all sources of noise. Use two power-supply decoupling capacitors

1μF and 0.1μF and place them close to the VDDA and VDDD pins of the device.

## Typical Circuit

A typical application for the ISL29018 is shown in Figure 6. The ISL29018's I<sup>2</sup>C address is internally hardwired as 1000100. The device can be tied onto a system's I<sup>2</sup>C bus together with other I<sup>2</sup>C compliant devices.

## Soldering Considerations

Convection heating is recommended for reflow soldering; direct-infrared heating is not recommended. The plastic ODFN package does not require a custom reflow soldering profile, and is qualified to +260 °C. A standard reflow soldering profile with a +260 °C maximum is recommended.

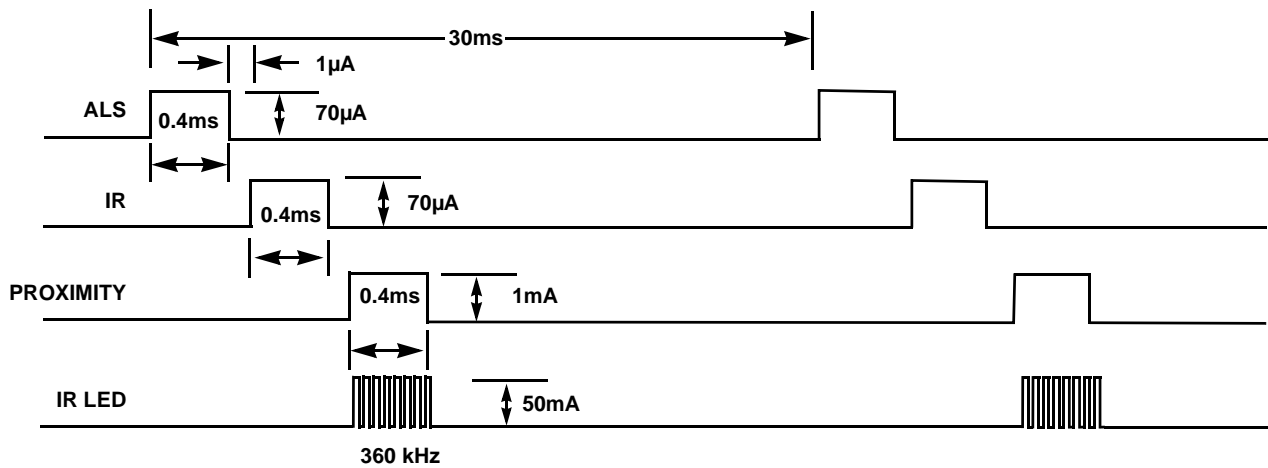

FIGURE 5. CURRENT CONSUMPTION FOR EACH INTEGRATION PHASE AND DETECTION CYCLE

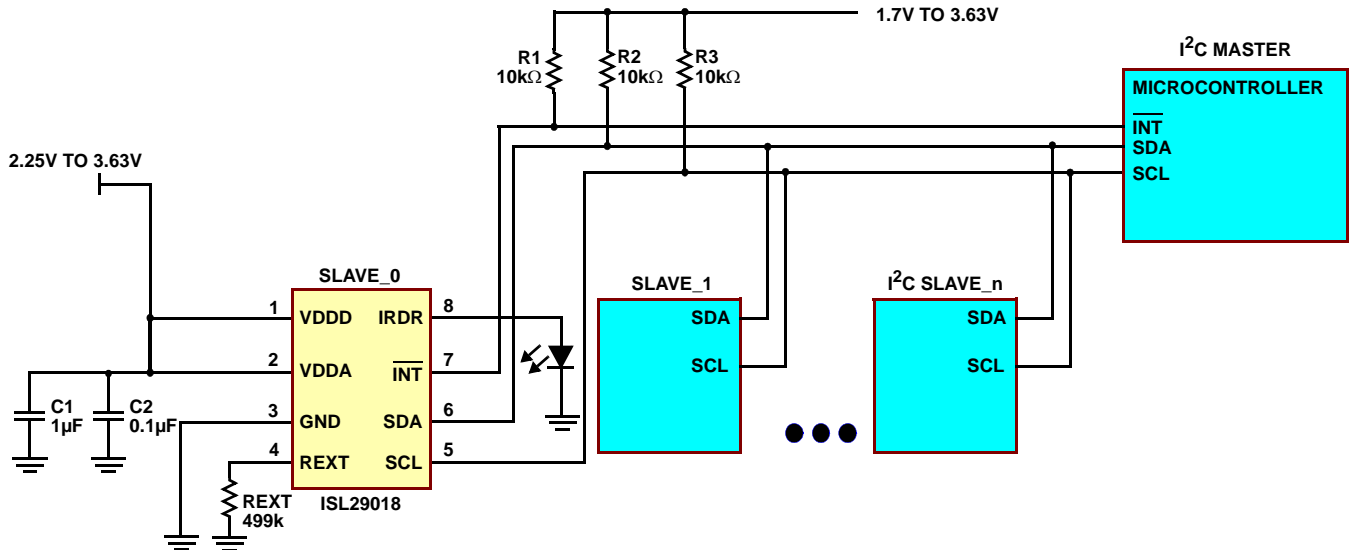

FIGURE 6. ISL29018 TYPICAL CIRCUIT

**Typical Performance Curves**  $V_{SUP} (V_{DD}, V_{DDA}) = 3V, R_{EXT} = 499k\Omega$

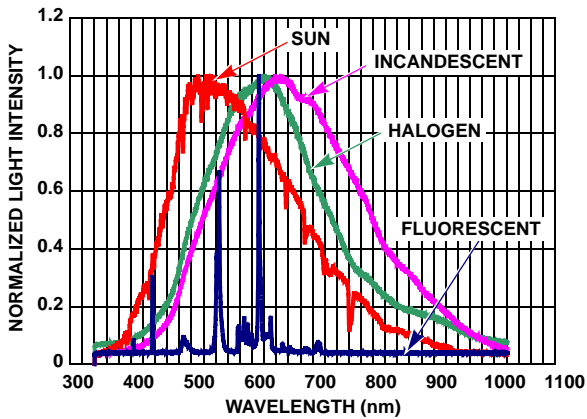

FIGURE 7. SPECTRUM OF FOUR LIGHT SOURCES

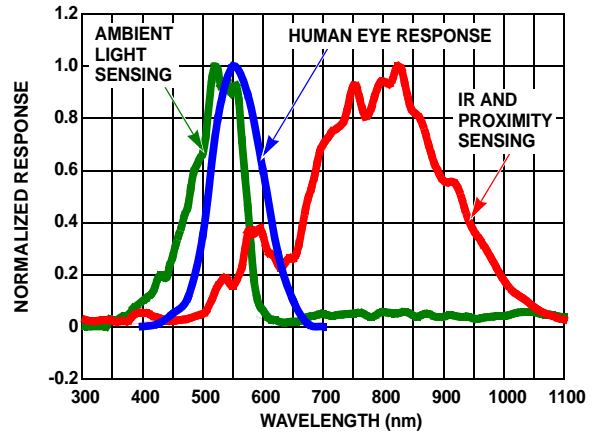

FIGURE 8. SPECTRAL RESPONSE FOR AMBIENT LIGHT SENSING AND PROXIMITY SENSING

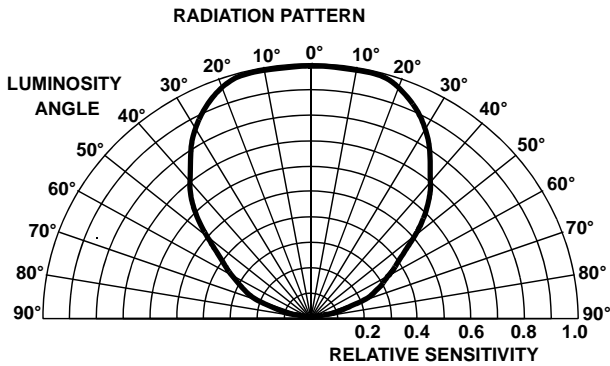

FIGURE 9. RADIATION PATTERN

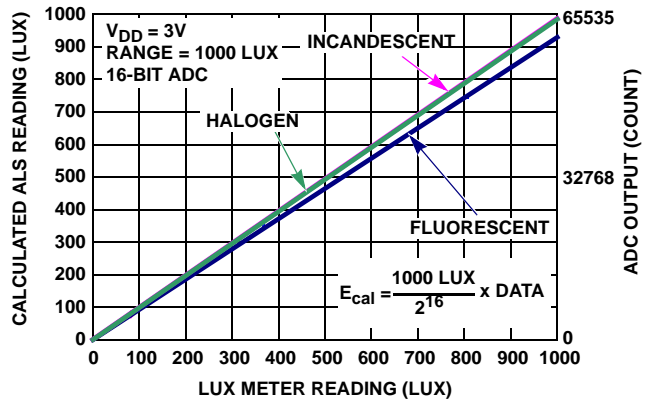

FIGURE 10. SENSITIVITY TO THREE LIGHT SOURCES

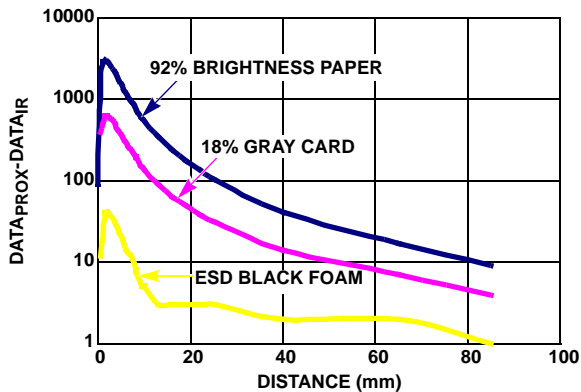

FIGURE 11. ADC OUTPUT vs DISTANCE WITH DIFFERENT OBJECTS IN PROXIMITY SENSING

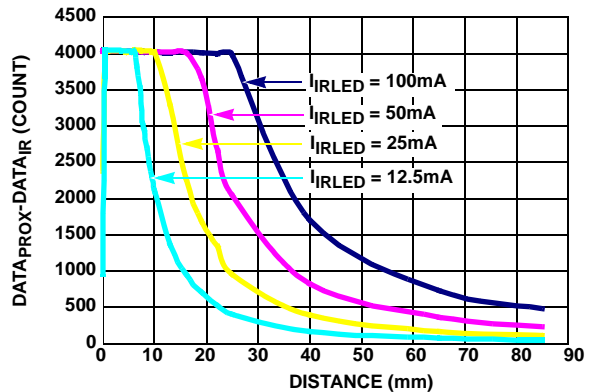

FIGURE 12. ADC OUTPUT vs DISTANCE WITH DIFFERENT LED CURRENT AMPLITUDES IN PROXIMITY SENSING

## Typical Performance Curves $V_{SUP} (V_{DD}, V_{DDA}) = 3V, R_{EXT} = 499k\Omega$ (Continued)

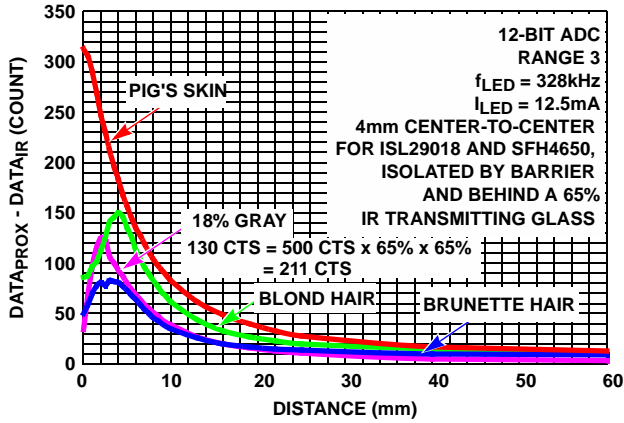

FIGURE 13. PROXIMITY DETECTIONS OF VARIOUS BIOLOGICAL OBJECTS

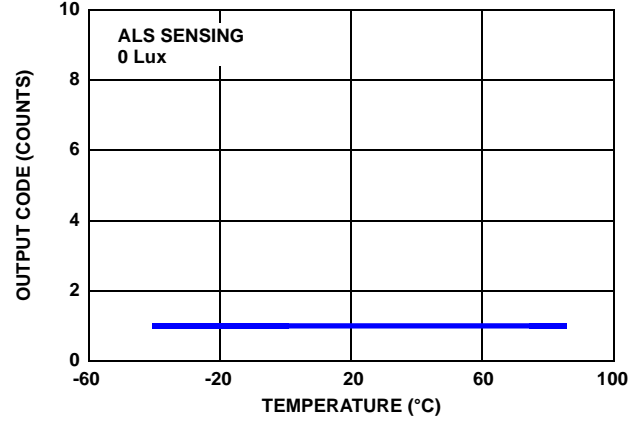

FIGURE 14. OUTPUT CODE FOR 0 LUX vs TEMPERATURE

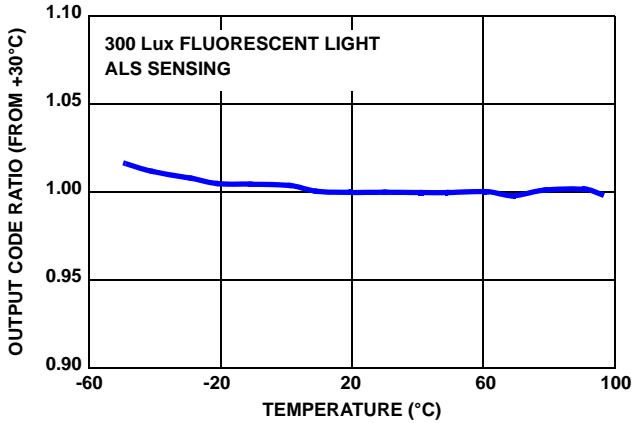

FIGURE 15. OUTPUT CODE vs TEMPERATURE

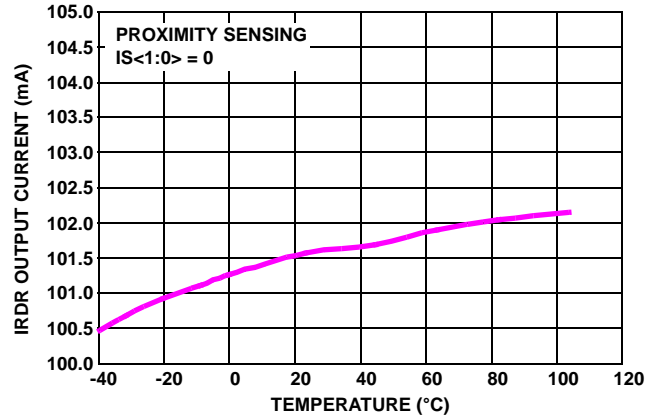

FIGURE 16. OUTPUT CURRENT vs TEMPERATURE IN PROXIMITY SENSING

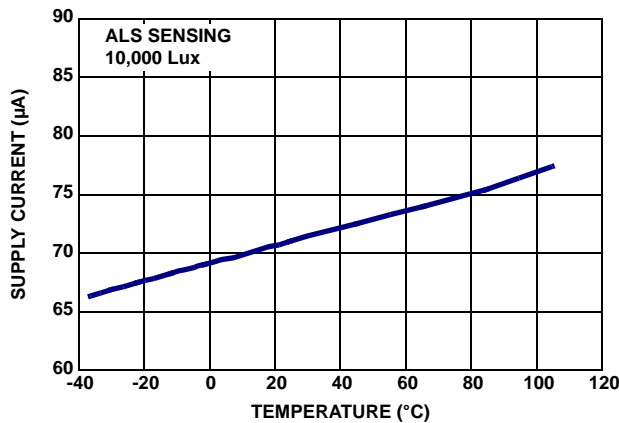

FIGURE 17. SUPPLY CURRENT vs TEMPERATURE IN ALS SENSING



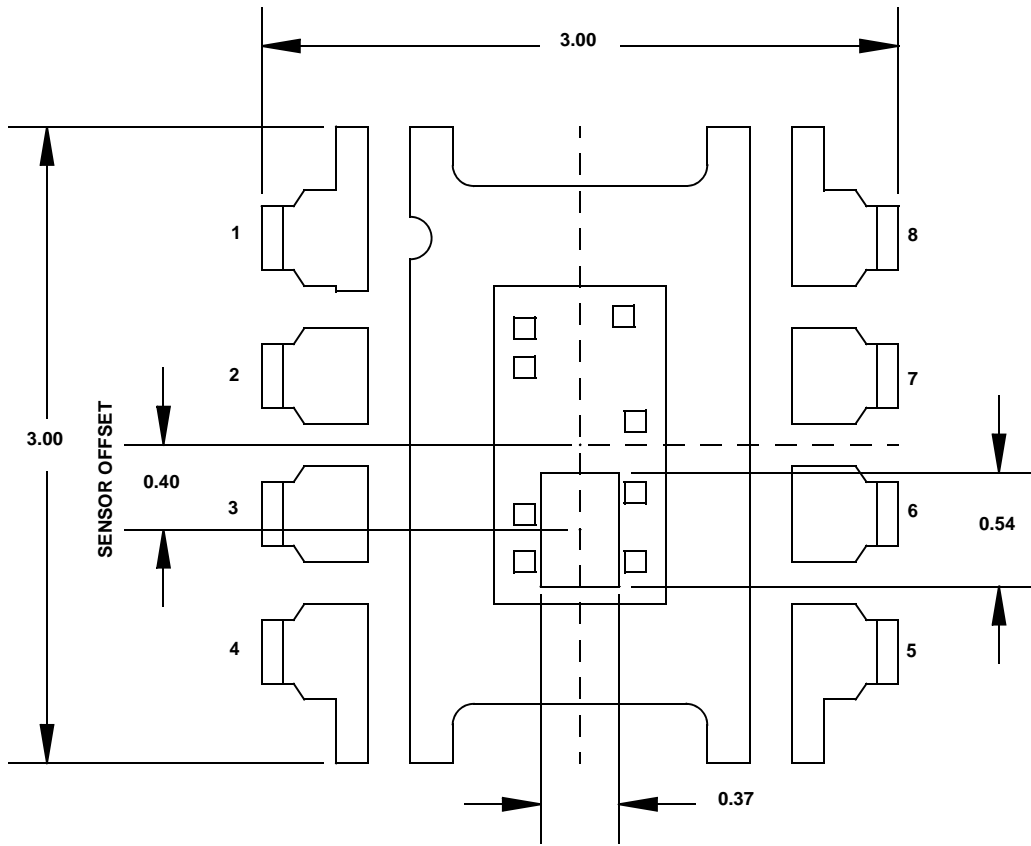

FIGURE 18. 8 LD ODFN SENSOR LOCATION OUTLINE

## Revision History

The revision history provided is for informational purposes only and is believed to be accurate, but not warranted. Please go to web to make sure you have the latest revision.

| DATE             | REVISION | CHANGE   |
|------------------|----------|--|
| April 11, 2012   | FN6619.4 | <ul style="list-style-type: none"><li>• In "Thermal Information" on page 4, corrected <math>\theta_{JA}</math> from 88 to 62 °C/W.</li><li>• In Table 11 on page 12, removed row with <math>R_{EXT}</math> value of 250k.</li></ul>  |
| November 1, 2011 | FN6619.3 | <ul style="list-style-type: none"><li>• On page 5, Electrical Specifications: changed TYP value for <math>V_{IRLED}</math> (Voltage Head Room of IRDR Pin) from VDD-0.6 to VDD-1.0 and added to Conditions column: "IRDR = 90mA, IS&lt;1:0&gt; = 0 (Note 8)"</li><li>• On page 8, added section, "Changing States - Avoiding Unintentional Interrupts" with Figure 2, "Changing States Flow Example".</li><li>• Converted to new datasheet template.</li><li>• Added Revision History table.</li></ul> |

## About Intersil

Intersil Corporation is a leader in the design and manufacture of high-performance analog, mixed-signal and power management semiconductors. The company's products address some of the largest markets within the industrial and infrastructure, personal computing and high-end consumer markets. For more information about Intersil, visit our website at [www.intersil.com](http://www.intersil.com).

For the most updated datasheet, application notes, related documentation and related parts, please see the respective product information page found at [www.intersil.com](http://www.intersil.com). You may report errors or suggestions for improving this datasheet by visiting [www.intersil.com/en/support/ask-an-expert.html](http://www.intersil.com/en/support/ask-an-expert.html). Reliability reports are also available from our website at <http://www.intersil.com/en/support/qualandreliability.html#reliability>

For additional products, see [www.intersil.com/product\\_tree](http://www.intersil.com/product_tree)

Intersil products are manufactured, assembled and tested utilizing ISO9000 quality systems as noted in the quality certifications found at [www.intersil.com/design/quality](http://www.intersil.com/design/quality)

*Intersil products are sold by description only. Intersil Corporation reserves the right to make changes in circuit design, software and/or specifications at any time without notice. Accordingly, the reader is cautioned to verify that data sheets are current before placing orders. Information furnished by Intersil is believed to be accurate and reliable. However, no responsibility is assumed by Intersil or its subsidiaries for its use; nor for any infringements of patents or other rights of third parties which may result from its use. No license is granted by implication or otherwise under any patent or patent rights of Intersil or its subsidiaries.*

For information regarding Intersil Corporation and its products, see [www.intersil.com](http://www.intersil.com)

## Package Outline Drawing

### L8.3x3F

8 LEAD OPTICAL DUAL FLAT NO-LEAD PLASTIC PACKAGE

Rev 0, 01/07

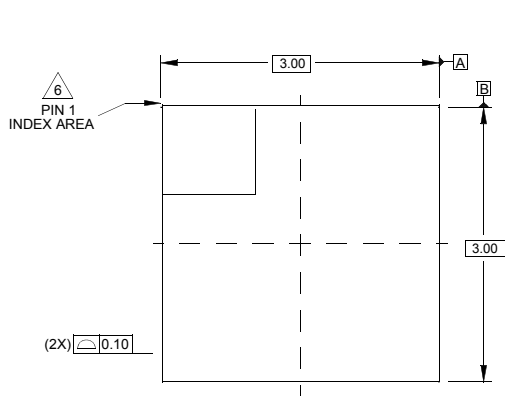

TOP VIEW

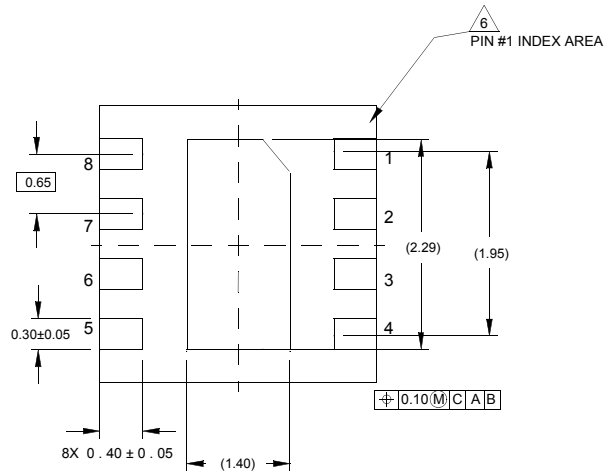

BOTTOM VIEW

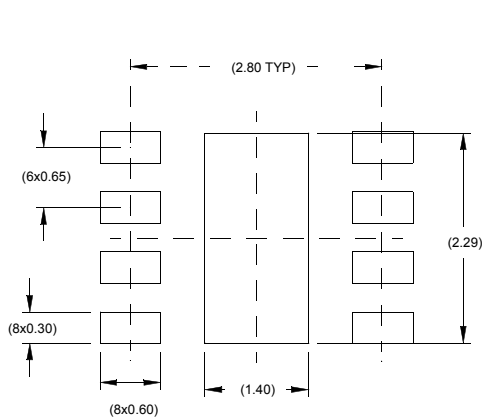

TYPICAL RECOMMENDED LAND PATTERN

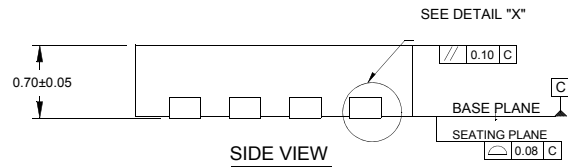

SIDE VIEW

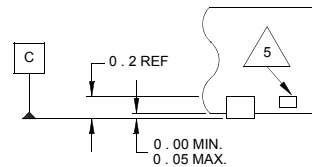

DETAIL "X"

#### NOTES:

- Dimensions are in millimeters.  
Dimensions in ( ) for Reference Only.
- Dimensioning and tolerancing conform to AMSE Y14.5m-1994.
- Unless otherwise specified, tolerance : Decimal  $\pm 0.05$
- Dimension b applies to the metallized terminal and is measured between 0.25mm and 0.35mm from the terminal tip.
- Tiebar shown (if present) is a non-functional feature.
- The configuration of the pin #1 identifier is optional, but must be located within the zone indicated. The pin #1 identifier may be either a mold or mark feature.

# Mouser Electronics

Authorized Distributor

Click to View Pricing, Inventory, Delivery & Lifecycle Information:

[Intersil:](#)

[ISL29018IROZ-EVALZ](#)