

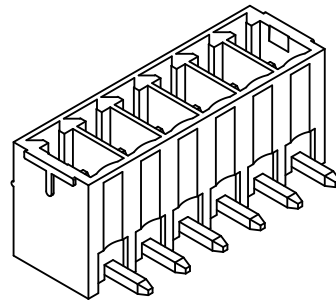

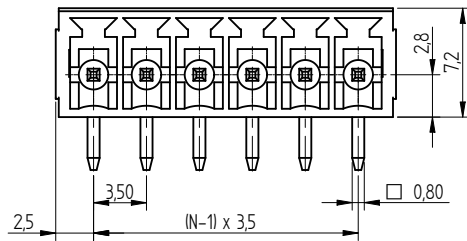

sectional drawing A-A

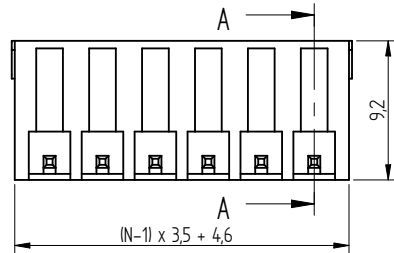
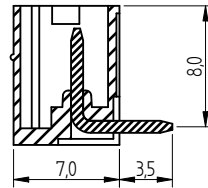

		Projection 		GENERAL TOLERANCE .x = +/- 0,2 .xx = +/- 0,15		Basic material		
				Date Drawn <b>08-11-04</b>	Name <b>Jelisarow</b>	DESCRIPTION WERI		
				Checked		3,50mm Horizontal PCB Header WR-TBL		
				 Würth Elektronik RDX		Scale <b>2:1</b>	Position	
						Drawing.- No. <b>6913221100xx</b>		
REV	FILE	DATE	BY	EDV NO <b>6913221100xx.dft</b>			SIZE <b>A4</b>	
							System Solid Edge V19	

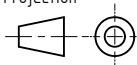
# Mouser Electronics

Authorized Distributor

Click to View Pricing, Inventory, Delivery & Lifecycle Information:

[Wurth Elektronik:](#)

[691322110007](#)