

1

2

3

4

5

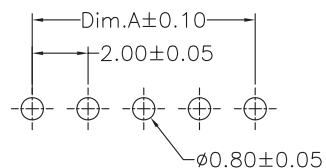
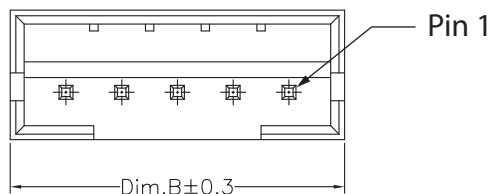
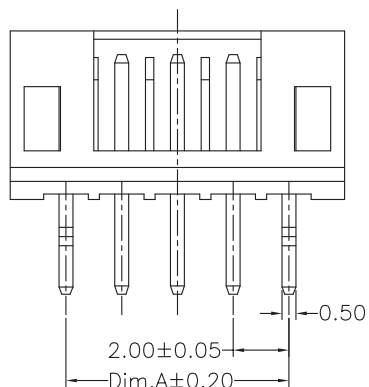
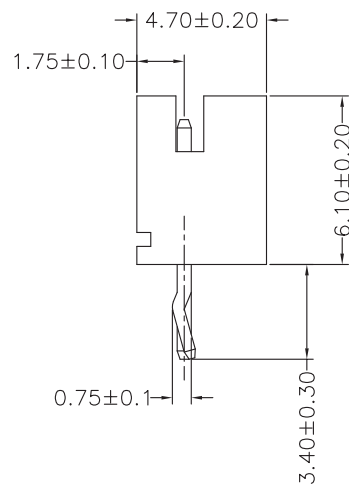

PCB LAYOUT - COMPONENT VIEW

TECHNICAL CHARACTERISTICS

MATERIAL
 INSULATOR: PA 46
 FLAMMABILITY RATING: UL94-V0
 COLOR: BEIGE
 CONTACT MATERIAL: COPPER ALLOY
 CONTACT TYPE: STAMPED
 CONTACT PLATING: TIN
 QUALITY CLASS: 25 MATING CYCLES
 PITCH: 2.00 MM

ENVIRONMENTAL
 OPERATING TEMPERATURE: -25 UP TO 85°C
 COMPLIANCE: LEAD FREE AND ROHS

ELECTRICAL
 CURRENT RATING: 2A
 WORKING VOLTAGE: 125 VAC
 INSULATOR RESISTANCE: >1000 MOHM
 DIELECTRIC WITHSTANDING VOLTAGE: 800 VAC/MN
 CONTACT RESISTANCE: 20 mOHM MAX

STANDARD
 CERTIFIED: E323964

SOLDERING
 JEDEC LEAD FREE WAVE SOLDERING

PACKAGING
 BAG

DIMENSION
 A = 2.00 x (NB PIN - 1)
 B = 2.00 x (NB PIN - 1) + 4.00

PROJECTION:



GENERAL TOLERANCE

.X = ± 0.2 .XX = ± 0.15 

APPROVAL: BBu

UNIT: MM

SCALE:

SHEET: 1/3

DRAW:

DESCRIPTION: 2.00 MM MALE VERTICAL SHROUDED HEADER

WERI PART NO: 620 0xx 116 22

SIZE

A4

REV	DATE	FILE	BY
J	02-FEV-18	QT TPK	AK
I	31-AUG-16	COLOR	AK
H	02-DEC-15	UPDATE	AK

1

2

3

4

5

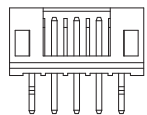

PE BAG

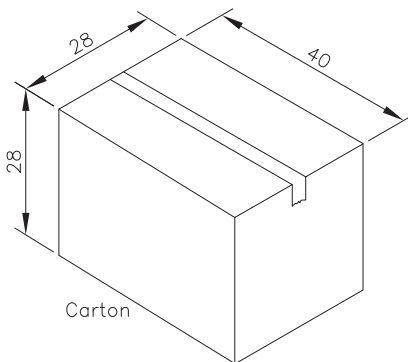
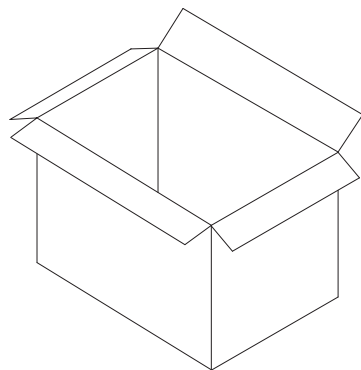
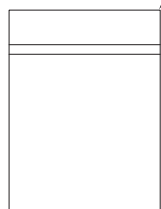

Carton

Pin.	Pcs/Bag	Pcs/Carton	Pin.	Pcs/Bag	Pcs/Carton
2	1000	75000	9	500	20000
3	1000	56000	10	500	17000
4	1000	44000	11	500	14000
5	1000	38000	12	500	12000
6	500	32000	13	500	11000
7	500	26000	14	500	11000
8	500	22000	15	500	9000

G			
F			
E			
D			
C			
B			
A			
REV	DATE	FILE	BY

PROJECTION:



GENERAL TOLERANCE

.X = +/- 0.2

.XX = +/- 0.15

APPROVAL: BBu

UNIT: MM

SCALE:

SHEET: 2/3

DRAW:



WÜRTH ELEKTRONIK

DESCRIPTION: 2.00 MM MALE VERTICAL SHROUDED HEADER

WERI PART NO: 620 0xx 116 22

SIZE

A4

A

B

C

D

1

2

3

4

5

Cautions and Warnings:

This electronic component is designed and developed with the intention for use in general electronics equipments.

Before incorporating the components into any equipments in the field such as aerospace, aviation, nuclear control, submarine, transportation, (automotive control, train control, ship control), transportation signal, disaster prevention, medical, public information network etc. where higher safety and reliability are especially required or if there is possibility of direct damage or injury to human body, Würth Elektronik must be asked for a written approval.



In addition, even electronic component in general electronic equipments, when used in electrical circuits that require high safety, reliability functions or performance, the sufficient reliability evaluation-check for the safety must be performed before by the user before usage.

A

B

C

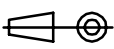
RoHS Compliant

G				PROJECTION: 	GENERAL TOLERANCE .X = +/- 0.2 .XX = +/- 0.15		
F							
E							
D							
C				APPROVAL: JC	UNIT: MM	DESCRIPTION: DISCLAIMER	SIZE A4
B					SCALE:		
A	10-SEP-14	PDF	QL		SHEET: 3/3	WERI PART NO: DISCLAIMER	
REV	DATE	FILE	BY		DRAW: QL		

D

Mouser Electronics

Authorized Distributor

Click to View Pricing, Inventory, Delivery & Lifecycle Information:

[Wurth Elektronik:](#)

[62000711622](#)