

# Optocoupler, Phototransistor Output, Low Input Current, SOP-4, Mini-Flat Package

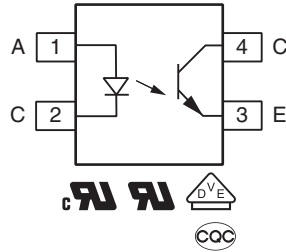

## DESCRIPTION

The VOMA617A series has a GaAlAs infrared emitting diode, which is optically coupled to a silicon planar phototransistor detector, and is incorporated in a 4-pin mini-flat package.

It features a high current transfer ratio at low input current, low coupling capacitance, and high isolation voltage.

The coupling devices are designed for signal transmission between two electrically separated circuits, specifically for use in automotive, as well as high reliable industrial applications.

## FEATURES

- AEC-Q101 qualified
- High CTR with low input current
- SOP-4 low profile package
- High collector emitter voltage,  $V_{CE0} = 80\text{ V}$
- Isolation test voltage =  $3750\text{ V}_{RMS}$
- Low coupling capacitance
- Material categorization: for definitions of compliance please see [www.vishay.com/doc?99912](http://www.vishay.com/doc?99912)

## APPLICATIONS

- Galvanic and noise isolation
- Signal transmission
- Hybrid / electric vehicle applications
- Battery management
- 48 V board net
- System control

## AGENCY APPROVALS

- UL1577
- cUL 1577
- DIN EN 60747-5-5 (VDE 0884-5)
- CQC GB4943.1-2011

 AUTOMOTIVE  
GRADE

**RoHS**  
COMPLIANT  
HALOGEN  
**FREE**  
**GREEN**  
(5-2008)

## ORDERING INFORMATION

V	O	M	A	6	1	7	A	-	#	X	0	0	1	T
PART NUMBER									CTR BIN	PACKAGE OPTION			TAPE AND REEL	

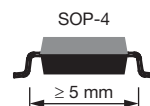

AGENCY CERTIFIED / PACKAGE	CTR (%)			
	5 mA			
UL, cUL, VDE, CQC	50 to 600	100 to 200	160 to 320	130 to 260
SOP-4	VOMA617A-X001T	VOMA617A-3X001T	VOMA617A-4X001T	VOMA617A-8X001T

### Note

- Additional options may be possible, please contact sales office



ABSOLUTE MAXIMUM RATINGS ( $T_{amb} = 25\text{ }^{\circ}\text{C}$ , unless otherwise specified)				
PARAMETER	TEST CONDITION	SYMBOL	VALUE	UNIT
<b>INPUT</b>				
Reverse voltage		$V_R$	5	V
Power dissipation		$P_{diss}$	30	mW
Forward current		$I_F$	20	mA
Surge forward current	$t_p \leq 10\text{ }\mu\text{s}$	$I_{FSM}$	0.5	A
Junction temperature		$T_j$	125	$^{\circ}\text{C}$
<b>OUTPUT</b>				
Collector emitter voltage		$V_{CEO}$	80	V
Emitter collector voltage		$V_{ECO}$	7	V
Collector current		$I_C$	50	mA
Power dissipation		$P_{diss}$	150	mW
Junction temperature		$T_j$	125	$^{\circ}\text{C}$
<b>COUPLER</b>				
Total power dissipation		$P_{tot}$	180	mW
Storage temperature range		$T_{stg}$	-40 to +150	$^{\circ}\text{C}$
Ambient temperature range		$T_{amb}$	-40 to +110	$^{\circ}\text{C}$
Soldering temperature	$t = 10\text{ s}$	$T_{sld}$	260	$^{\circ}\text{C}$

Note

- Stresses in excess of the absolute maximum ratings can cause permanent damage to the device. Functional operation of the device is not implied at these or any other conditions in excess of those given in the operational sections of this document. Exposure to absolute maximum ratings for extended periods of the time can adversely affect reliability

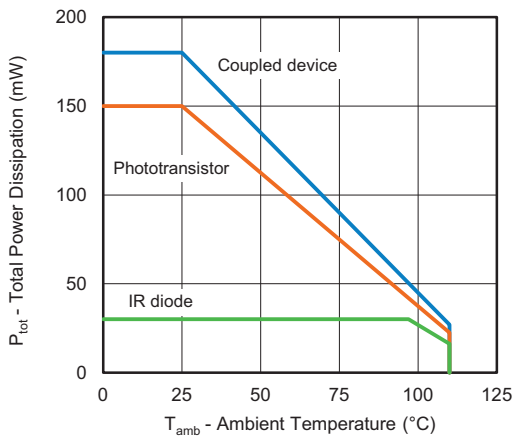

Fig. 1 - Power Dissipation vs. Ambient Temperature

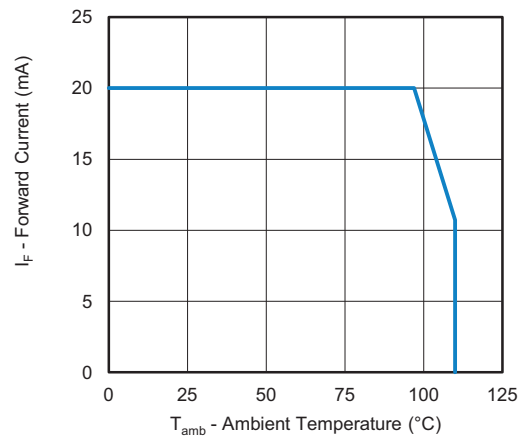

Fig. 2 - Maximum Forward Current vs. Ambient Temperature

<b>ELECTRICAL CHARACTERISTICS</b> ( $T_{amb} = 25\text{ }^{\circ}\text{C}$ , unless otherwise specified)						
PARAMETER	TEST CONDITION	SYMBOL	MIN.	TYP.	MAX.	UNIT
<b>INPUT</b>						
Forward voltage	$I_F = 5\text{ mA}$	$V_F$	-	1.33	1.5	V
Reverse current	$V_R = 5\text{ V}$	$I_R$	-	-	10	$\mu\text{A}$
Capacitance	$V_R = 0\text{ V}$ , $f = 1\text{ MHz}$	$C_I$	-	40	-	pF
<b>OUTPUT</b>						
Collector emitter leakage current	$V_{CE} = 50\text{ V}$	$I_{CEO}$	-	1	100	nA
Collector emitter breakdown voltage	$I_C = 100\text{ }\mu\text{A}$	$BV_{CEO}$	80	-	-	V
Collector emitter capacitance	$V_{CE} = 5\text{ V}$ , $f = 1\text{ MHz}$	$C_{CE}$	-	7	-	pF
<b>COUPLER</b>						
Collector emitter saturation voltage	$I_F = 5\text{ mA}$ , $I_C = 1.25\text{ mA}$	$V_{CEsat}$	-	0.25	0.4	V
Cut-off frequency	$I_F = 10\text{ mA}$ , $V_{CC} = 5\text{ V}$ , $R_L = 100\text{ }\Omega$	$f_{CTR}$	-	155	-	kHz
Coupling capacitance	$f = 1\text{ MHz}$	$C_{IO}$	-	1.2	-	pF

**Note**

- Minimum and maximum values are testing requirements. Typical values are characteristics of the device and are the result of engineering evaluation. Typical values are for information only and are not part of the testing requirements

<b>CURRENT TRANSFER RATIO</b> ( $T_{amb} = 25\text{ }^{\circ}\text{C}$ , unless otherwise specified)							
PARAMETER	TEST CONDITION	PART	SYMBOL	MIN.	TYP.	MAX.	UNIT
$I_C/I_F$	$I_F = 5\text{ mA}$ , $V_{CE} = 5\text{ V}$	VOMA617A	CTR	50	-	600	%
		VOMA617A-3	CTR	100	-	200	%
		VOMA617A-4	CTR	160	-	320	%
		VOMA617A-8	CTR	130	-	260	%

<b>SWITCHING CHARACTERISTICS</b> ( $T_{amb} = 25\text{ }^{\circ}\text{C}$ , unless otherwise specified)						
PARAMETER	TEST CONDITION	SYMBOL	MIN.	TYP.	MAX.	UNIT
<b>NON-SATURATED</b>						
Rise time	$I_C = 2\text{ mA}$ , $V_{CC} = 5\text{ V}$ , $R_L = 100\text{ }\Omega$	$t_r$	-	2.3	-	$\mu\text{s}$
Fall time		$t_f$	-	3.2	-	$\mu\text{s}$
Turn-on time		$t_{on}$	-	4.9	-	$\mu\text{s}$
Turn-off time		$t_{off}$	-	3.3	-	$\mu\text{s}$
<b>SATURATED</b>						
Rise time	$I_F = 5\text{ mA}$ , $V_{CC} = 5\text{ V}$ , $R_L = 1.9\text{ k}\Omega$	$t_r$	-	1.1	-	$\mu\text{s}$
Fall time		$t_f$	-	6.2	-	$\mu\text{s}$
Turn-on time		$t_{on}$	-	2.0	-	$\mu\text{s}$
Turn-off time		$t_{off}$	-	10.6	-	$\mu\text{s}$

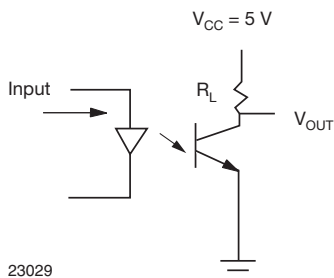

Fig. 3 - Test Circuit for Switching Characteristics

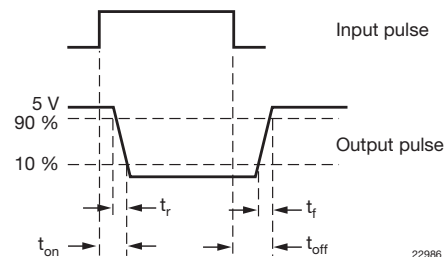

Fig. 4 - Parameter and Limit Definition

SAFETY AND INSULATION RATINGS				
PARAMETER	TEST CONDITION	SYMBOL	VALUE	UNIT
Climatic classification	According to IEC 68 part 1		40 / 110 / 21	
Pollution degree	According to DIN VDE 0109		2	
Comparative tracking index	Insulation group IIIa	CTI	175	
Maximum rated withstanding isolation voltage	According to UL1577, t = 1 min	$V_{ISO}$	3750	$V_{RMS}$
Maximum transient isolation voltage	According to DIN EN 60747-5-5	$V_{IOTM}$	6000	$V_{peak}$
Maximum repetitive peak isolation voltage	According to DIN EN 60747-5-5	$V_{IORM}$	707	$V_{peak}$
Isolation resistance	$T_{amb} = 25\text{ }^{\circ}\text{C}, V_{IO} = 500\text{ V}$	$R_{IO}$	$\geq 10^{12}$	$\Omega$
	$T_{amb} = 100\text{ }^{\circ}\text{C}, V_{IO} = 500\text{ V}$	$R_{IO}$	$\geq 10^{11}$	$\Omega$
	$T_{amb} = T_S, V_{IO} = 500\text{ V}$	$R_{IO}$	$\geq 10^9$	$\Omega$
Output safety power		$P_{SO}$	550	mW
Input safety current		$I_{SI}$	180	mA
Input safety temperature		$T_S$	175	$^{\circ}\text{C}$
Creepage distance			$\geq 5$	mm
Clearance distance			$\geq 5$	mm

**Note**

- As per IEC 60747-5-5, § 7.4.3.8.2, this optocoupler is suitable for “safe electrical insulation” only within the safety ratings. Compliance with the safety ratings shall be ensured by means of protective circuits

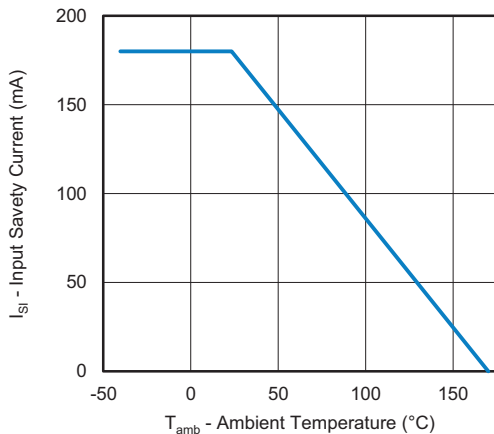

Fig. 5 - Input Safety Current vs. Ambient Temperature

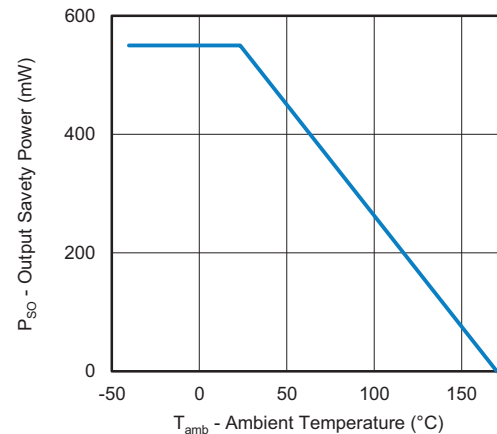

Fig. 6 - Output Safety Power vs. Ambient Temperature

**TYPICAL CHARACTERISTICS** ( $T_{amb} = 25\text{ }^{\circ}\text{C}$ , unless otherwise specified)

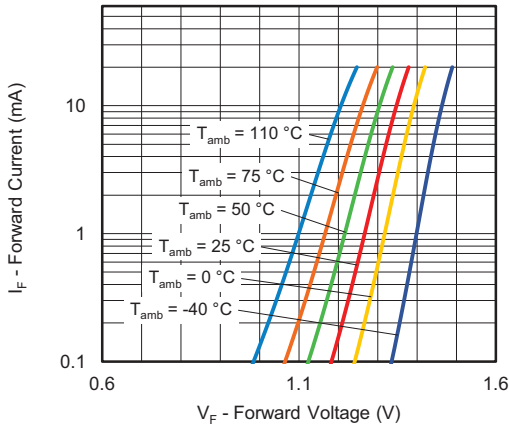

Fig. 7 - Forward Current vs. Forward Voltage

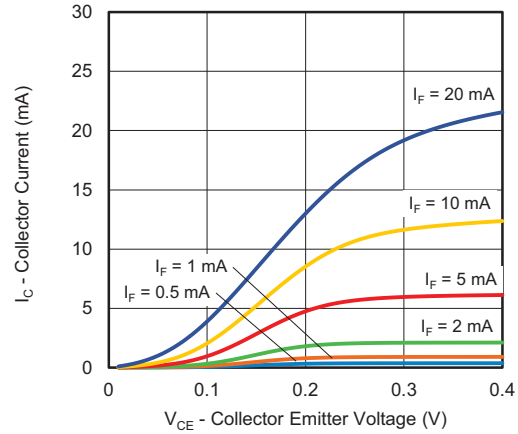

Fig. 10 - Collector Current vs. Collector Emitter Voltage (sat.)

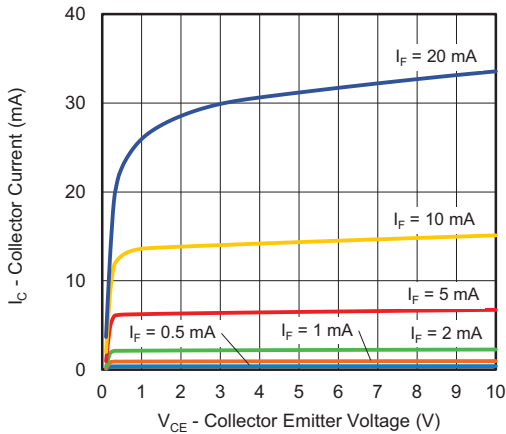

Fig. 8 - Collector Current vs. Collector Emitter Voltage (non-sat.)

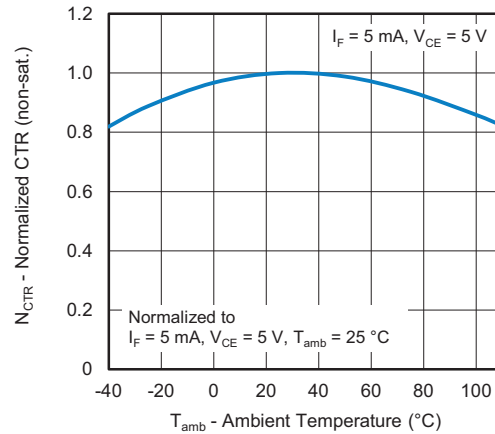

Fig. 11 - Normalized CTR (non-sat.) vs. Ambient Temperature

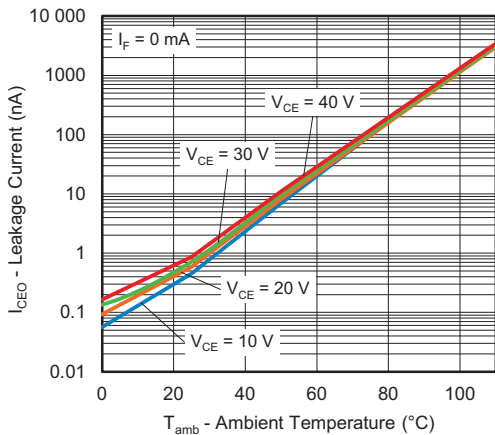

Fig. 9 - Leakage Current vs. Ambient Temperature

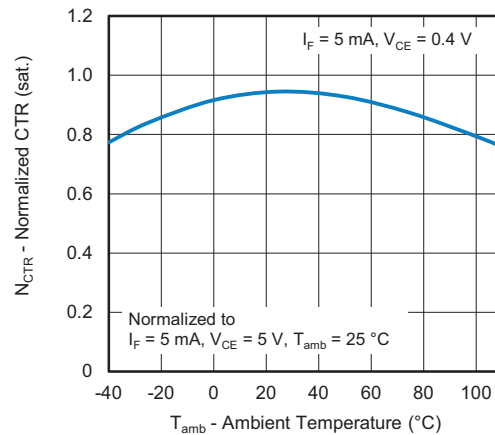

Fig. 12 - Normalized CTR (sat.) vs. Ambient Temperature

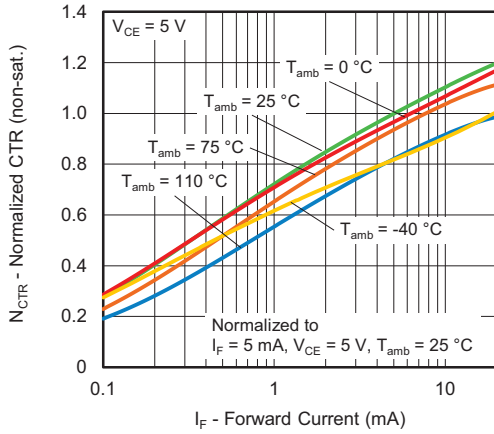

Fig. 13 - Normalized CTR (non-sat.) vs. Forward Current

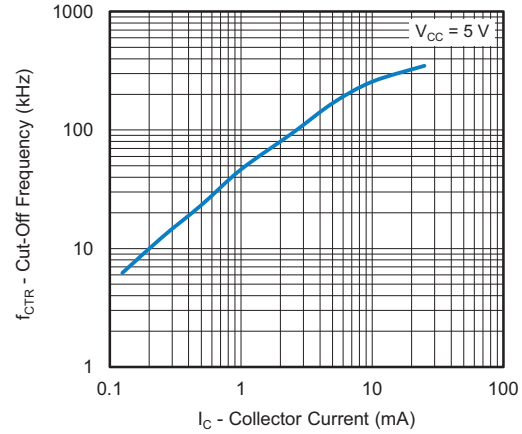

Fig. 16 - Cut-Off Frequency vs. Collector Current

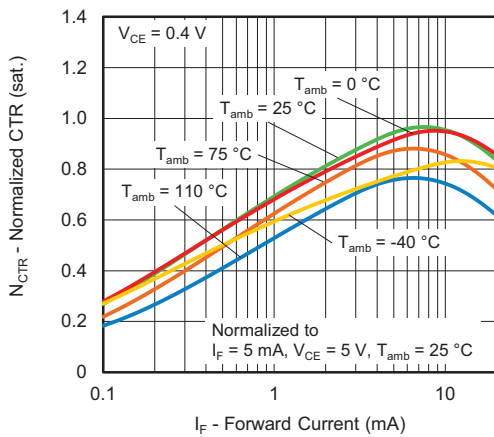

Fig. 14 - Normalized CTR (sat.) vs. Forward Current

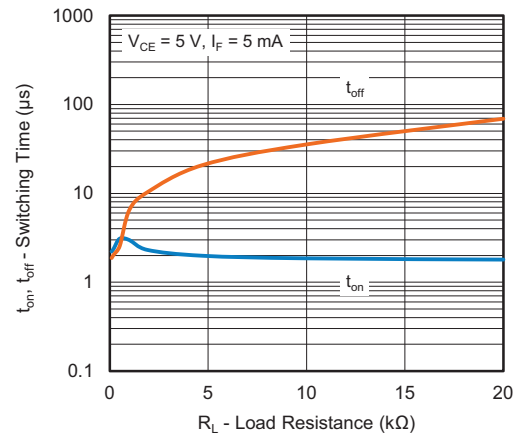

Fig. 17 - Switching Time vs. Load Resistance

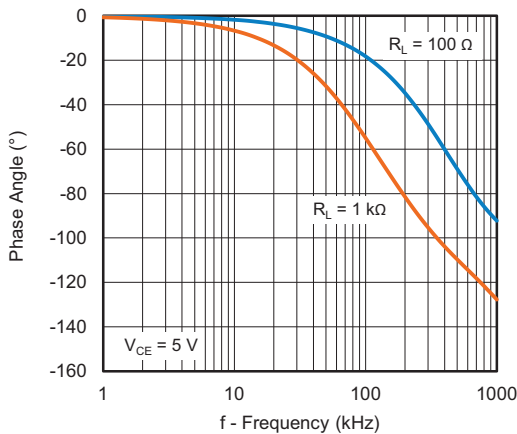

Fig. 15 - Phase Angle vs. Frequency

**PACKAGE DIMENSIONS** (in millimeters)

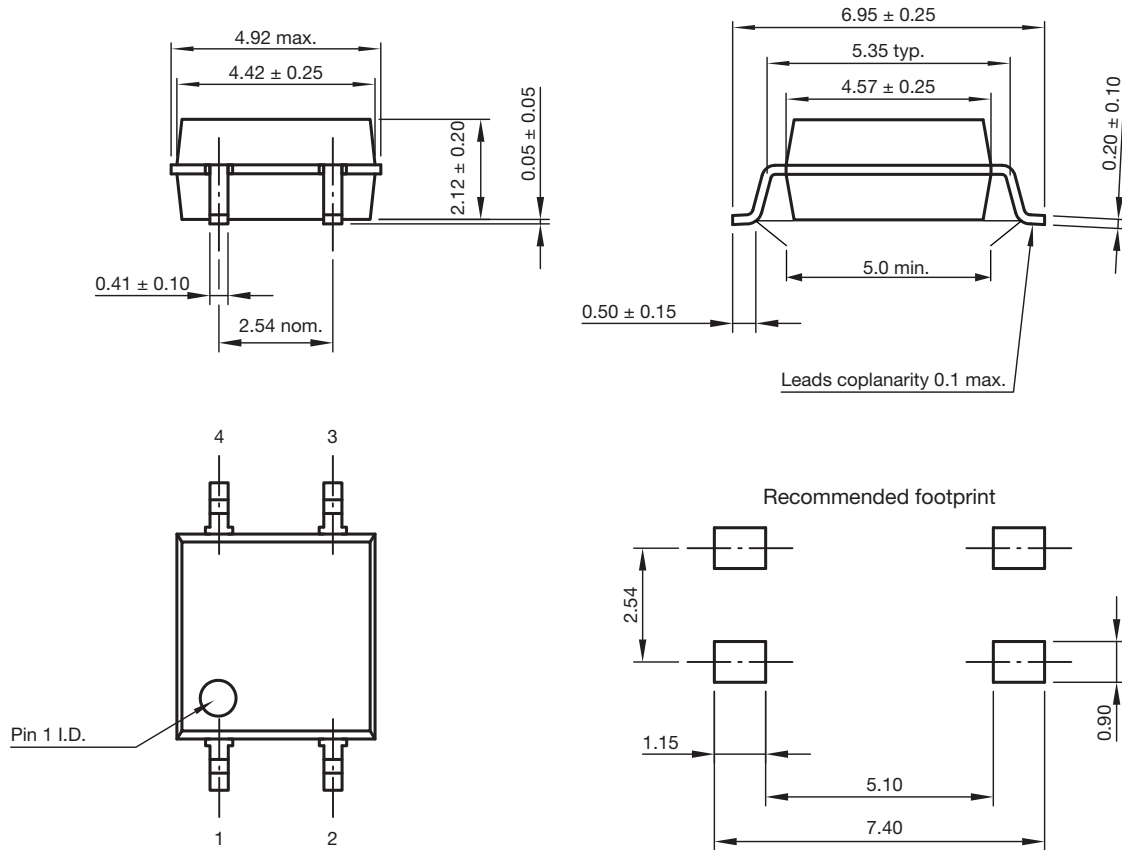
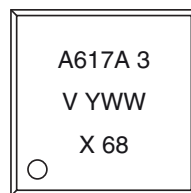

Fig. 18 - Package Drawing

**PACKAGE MARKING** (example of VOMA617A-3X001T)



**Notes**

- Option 1 is reflected with letter "X"
- Tape and reel suffix (T) is not part of the package marking

**PACKAGING INFORMATION** (in millimeters)

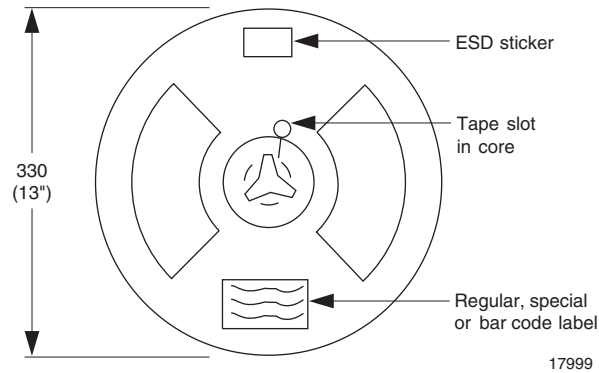
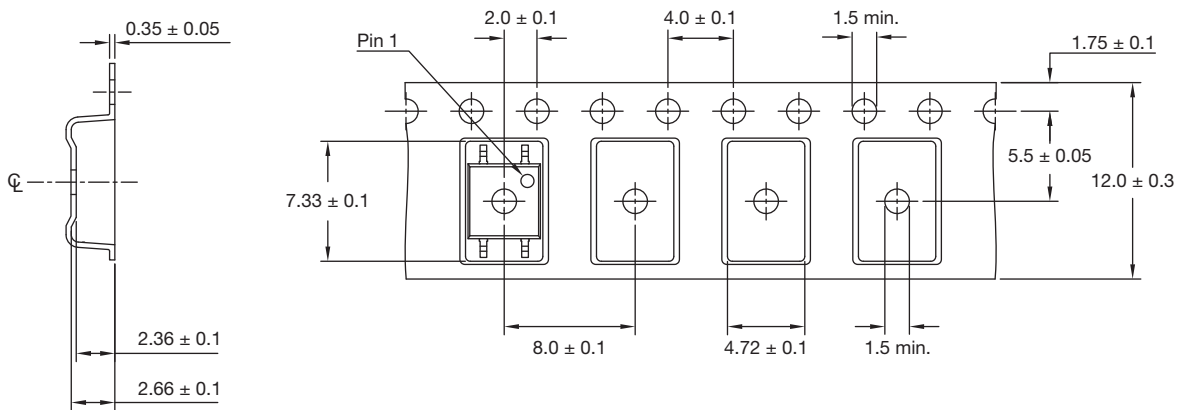

Fig. 19 - Tape and Reel Shipping Medium (EIA-481, revision A, and IEC 60286)



**Note**  
 • Cummulative tolerance of 10 spocket holes is 0.20 mm

Fig. 20 - Tape and Reel Packing

TAPE AND REEL PACKING	
TYPE	UNITS/REEL
SOP-4	2000





**SOLDER PROFILES**

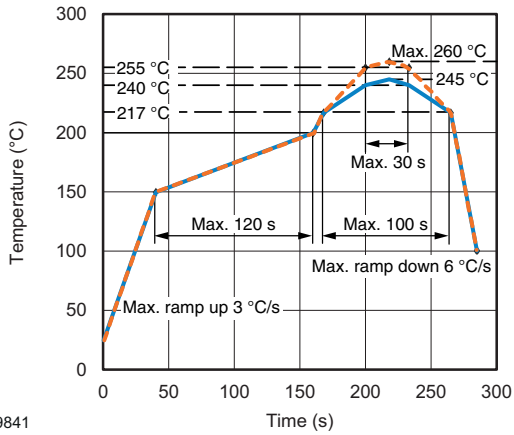

19841

Fig. 21 - Lead (Pb)-free Reflow Solder Profile According to J-STD-020 for SMD Devices

**HANDLING AND STORAGE CONDITIONS**

ESD level: HBM class 2

Floor life: 168 h

Conditions:  $T_{amb} < 30\text{ °C}$ ,  $RH \leq 60\%$

Moisture sensitivity level 3, according to J-STD-020



## **Disclaimer**

ALL PRODUCT, PRODUCT SPECIFICATIONS AND DATA ARE SUBJECT TO CHANGE WITHOUT NOTICE TO IMPROVE RELIABILITY, FUNCTION OR DESIGN OR OTHERWISE.

Vishay Intertechnology, Inc., its affiliates, agents, and employees, and all persons acting on its or their behalf (collectively, "Vishay"), disclaim any and all liability for any errors, inaccuracies or incompleteness contained in any datasheet or in any other disclosure relating to any product.

Vishay makes no warranty, representation or guarantee regarding the suitability of the products for any particular purpose or the continuing production of any product. To the maximum extent permitted by applicable law, Vishay disclaims (i) any and all liability arising out of the application or use of any product, (ii) any and all liability, including without limitation special, consequential or incidental damages, and (iii) any and all implied warranties, including warranties of fitness for particular purpose, non-infringement and merchantability.

Statements regarding the suitability of products for certain types of applications are based on Vishay's knowledge of typical requirements that are often placed on Vishay products in generic applications. Such statements are not binding statements about the suitability of products for a particular application. It is the customer's responsibility to validate that a particular product with the properties described in the product specification is suitable for use in a particular application. Parameters provided in datasheets and / or specifications may vary in different applications and performance may vary over time. All operating parameters, including typical parameters, must be validated for each customer application by the customer's technical experts. Product specifications do not expand or otherwise modify Vishay's terms and conditions of purchase, including but not limited to the warranty expressed therein.

Except as expressly indicated in writing, Vishay products are not designed for use in medical, life-saving, or life-sustaining applications or for any other application in which the failure of the Vishay product could result in personal injury or death. Customers using or selling Vishay products not expressly indicated for use in such applications do so at their own risk. Please contact authorized Vishay personnel to obtain written terms and conditions regarding products designed for such applications.

No license, express or implied, by estoppel or otherwise, to any intellectual property rights is granted by this document or by any conduct of Vishay. Product names and markings noted herein may be trademarks of their respective owners.

# Mouser Electronics

Authorized Distributor

Click to View Pricing, Inventory, Delivery & Lifecycle Information:

Vishay:

[VOMA617A-X001T](#) [VOMA617A-3X001T](#) [VOMA617A-8X001T](#) [VOMA617A-4X001T](#)