

28 V, 99 mΩ, Load Switch with Programmable Current Limit and Slew Rate Control

OPERATION DESCRIPTION

The SiP32430 is a load switch integrates multiple control features that simplify the design and increase the reliability of the circuitry connected to the switch. The SiP32430 is designed to operate in the 6 V to 28 V range.

An internally generated gate drive voltage ensures low switch resistance over the wide input voltage operating range.

The SiP32430 has a slew rate control circuit that programs the switch turn-on time to the value set by an external capacitor.

An over-current protection circuit (OCP) continuously monitors the current through the load switch. When the over current protection is triggered, the circuit controls the switch impedance to clamp the current to the level programmed by an external resistor. The trigger current is typically 8 % over the set current limit. In case the over-current condition persists for more than 7 ms, the switch shuts off automatically.

The SiP32430 has an over temperature protection circuit (OTP) which will shut the switch off immediately if the junction temperature exceeds over temperature limit of typically 150 °C. The OTP circuit will release the switch when the temperature has decreased by about 20 °C of hysteresis.

When an OCP or an OTP fault condition is detected the FLG pin is pulled low. The fault flag will release 150 ms after the fault condition is cleared, and the switch will automatically turn on at the programmed slew rate.

The SiP32430 features a low voltage control logic interface which can be controlled without the need for level shifting. It also includes a power good flag.

The SiP32430 is available in a space efficient DFN10 of 3 mm x 3 mm package.

FEATURES

- 6 V to 28 V operation
- Programmable soft start
- Programmable current limit
- Over temperature protection
- On resistance 99 mΩ
- Power good, when V_{OUT} reaches 90 % of V_{IN}
- OCP / OTP fault flag
- Under voltage lockout: 4.8 V / 5.4 V (typ. / max.)
- If no OTP, auto re-try to soft turn on 150 ms after the switch protected off
- Package: DFN10 3 mm x 3 mm
- Material categorization: for definitions of compliance please see www.vishay.com/doc?99912

APPLICATIONS

- Personal computers
- Lighting
- Flat panel displays
- Game consoles
- Industrial
- Network communication
- Data storage



RoHS
COMPLIANT
HALOGEN
FREE
Available

TYPICAL APPLICATION CIRCUIT

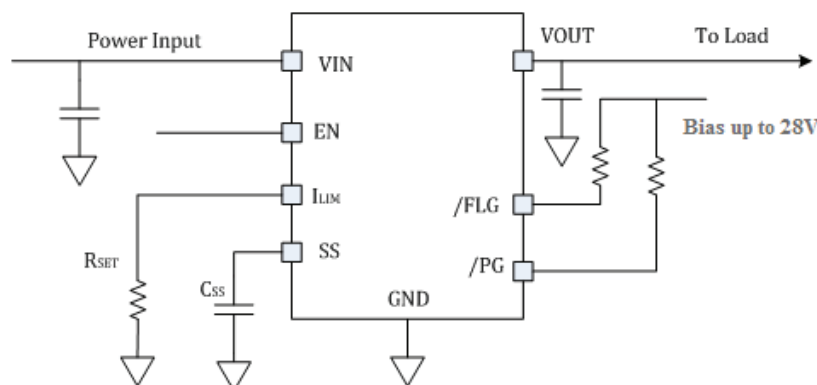


Fig. 1 - SiP32430 Typical Application Circuit



ORDERING INFORMATION			
TEMPERATURE RANGE	PACKAGE	MARKING	PART NUMBER
-40 °C to +85 °C	DFN10 3 mm x 3 mm	2430	SiP32430DN-T1-GE4

Note

- GE4 denotes halogen-free and RoHS-compliant

ABSOLUTE MAXIMUM RATINGS		
PARAMETER	LIMIT	UNIT
Input voltage (V_{IN})	-0.3 to 30	V
Output voltage (V_{OUT})	-0.3 to $V_{IN} + 0.3$ V	
PG voltage	-0.3 to 30	
FLG voltage	-0.3 to 30	
EN voltage	-0.3 to 6	
Maximum continuous switch current	3.2	A
ESD rating (HBM)	4000	V
Maximum junction temperature	150	°C
Storage temperature	-55 to +150	
Thermal resistance (θ_{thJA}) ^a	88	°C/W
Power dissipation (P_D) ^{a, b}	1.42	W

Notes

- Device mounted with all lead and power pad soldered or welded to PCB
- Derate 11.4 mW/°C above $T_A = 25$ °C

Stresses beyond those listed under "Absolute Maximum Ratings" may cause permanent damage to the device. These are stress ratings only, and functional operation of the device at these or any other conditions beyond those indicated in the operational sections of the specifications is not implied. Exposure to absolute maximum rating conditions for extended periods may affect device reliability.

RECOMMENDED OPERATING RANGE		
PARAMETER	LIMIT	UNIT
Input voltage (V_{IN})	6 to 28	V
V_{SS}	0 to 6	
V_{OUT}	0 to 28	
EN	0 to 6	
FLG, PG	0 to V_{IN}	
I_{LIM}	0 to 6	
Current limit	0.1 to 1	A
Operating temperature range	-40 to +85	°C



SPECIFICATIONS							
PARAMETER	SYMBOL	TEST CONDITIONS UNLESS SPECIFIED $V_{IN} = 12\text{ V}$, $V_{EN} = 2.4\text{ V}$, $T_A = 25\text{ }^\circ\text{C}$	TEMP.	MIN.	TYP.	MAX.	UNIT
Power input voltage	V_{IN}		-	6	-	28	V
Quiescent current	I_Q	$I_{OUT} = 0\text{ A}$, and device enabled	-	-	163	300	μA
Shutdown current	I_{SD}	$I_{OUT} = 0\text{ A}$, and device disabled	-	-	11	20	
Switch off leakage	$I_{(OFF)}$	$V_{IN} = 28\text{ V}$, $V_{OUT} = 0\text{ V}$ (current measured at output)	-	-	-	1	
Current limit clamp		$R_{SET} = 12\text{ k}\Omega$	$-40\text{ }^\circ\text{C}$ to $+85\text{ }^\circ\text{C}$	0.28	0.35	0.42	A
Current limit trigger		% above setting current	$-40\text{ }^\circ\text{C}$ to $+85\text{ }^\circ\text{C}$	-	8	-	%
Switch on resistance	$R_{DS(on)}$	$I_{SW} = 500\text{ mA}$	-	-	99	120	$\text{m}\Omega$
Soft start charge current	I_{SS}	Constant current source	-	-	4.5	-	μA
Turn on delay time	T_{ON_DLY}	50 % V_{EN} to 50 % V_{OUT} , $C_{SS} = \text{open}$, $R_L = 10\text{ }\Omega$, $C_{OUT} = 10\text{ }\mu\text{F}$	-	-	0.8	-	ms
		50 % V_{EN} to 50 % V_{OUT} , $C_{SS} = 47\text{ nF}$, $R_L = 10\text{ }\Omega$, $C_{OUT} = 10\text{ }\mu\text{F}$	-	-	6.7	-	
Turn on rise time	T_R	$C_{SS} = \text{open}$, $R_L = 10\text{ }\Omega$, $C_{OUT} = 10\text{ }\mu\text{F}$	-	-	1	-	
		$C_{SS} = 47\text{ nF}$, $R_L = 10\text{ }\Omega$, $C_{OUT} = 10\text{ }\mu\text{F}$	-	-	9.5	-	
		$C_{SS} = 47\text{ nF}$, no R_L , $C_{OUT} = 10\text{ }\mu\text{F}$	-	-	2.5	-	
Turn off delay	T_{OFF_DLY}		-	-	8	-	μs
Current limit response time			-	-	20	-	
Short circuit response time			-	-	1	-	
OC flag blanking time / switch off delay under OC			$-40\text{ }^\circ\text{C}$ to $+85\text{ }^\circ\text{C}$	4	-	-	ms
Auto-retry time			-	-	150	-	
Input logic high voltage	V_{ENH}	$V_{IN} = 6\text{ V}$ to 28 V	$-40\text{ }^\circ\text{C}$ to $+85\text{ }^\circ\text{C}$	1.5	-	-	V
Input logic low voltage	V_{ENL}		$-40\text{ }^\circ\text{C}$ to $+85\text{ }^\circ\text{C}$	-	-	0.6	
Input pull down resistor	R_{EN}	$V_{EN} = 5\text{ V}$	-	-	2.5	-	$\text{M}\Omega$
Power good trip voltage			-	-	$90\% \times V_{IN}$	-	V
Power good hysteresis			-	-	$3\% \times V_{IN}$	-	
$\overline{\text{PG}}$ and $\overline{\text{FLG}}$ output logic low voltage		$I_{SINK} = 1\text{ mA}$	-	-	< 0.1	-	
$\overline{\text{PG}}$ and $\overline{\text{FLG}}$ output high leakage		V_{PG} , $V_{FLG} = 28\text{ V}$	-	-	-	1	μA
UVLO threshold			-	-	4.8	5.4	V
UVLO hysteresis			-	-	0.28	-	
Thermal shutdown threshold			-	-	150	-	$^\circ\text{C}$
Thermal shutdown hysteresis			-	-	20	-	

TIMING DIAGRAM

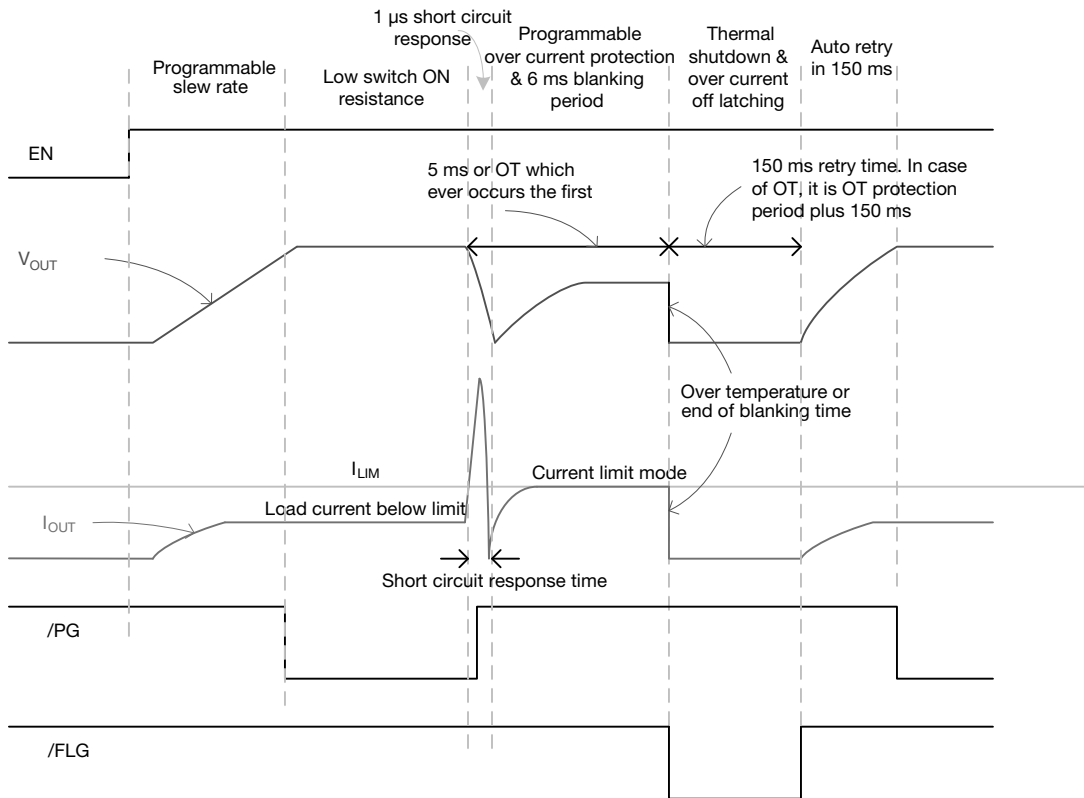


Fig. 2 - Timing Diagram

PIN CONFIGURATION

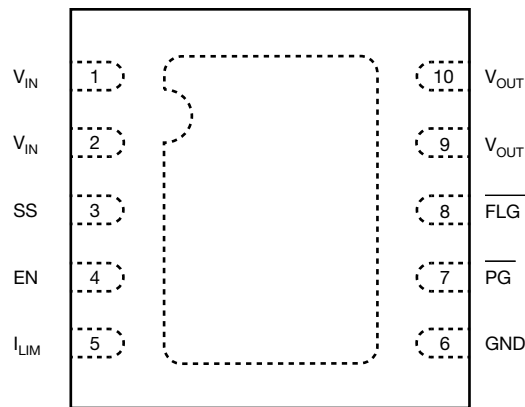
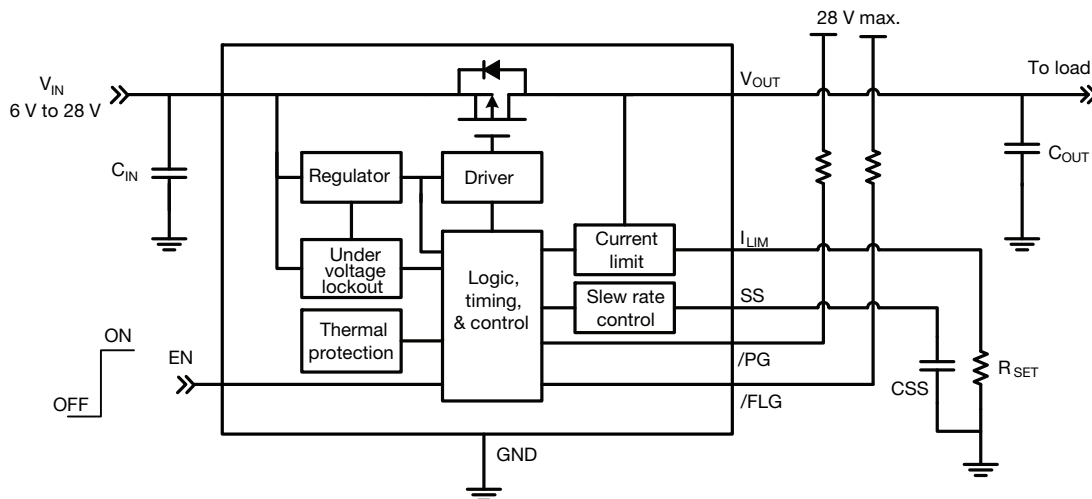
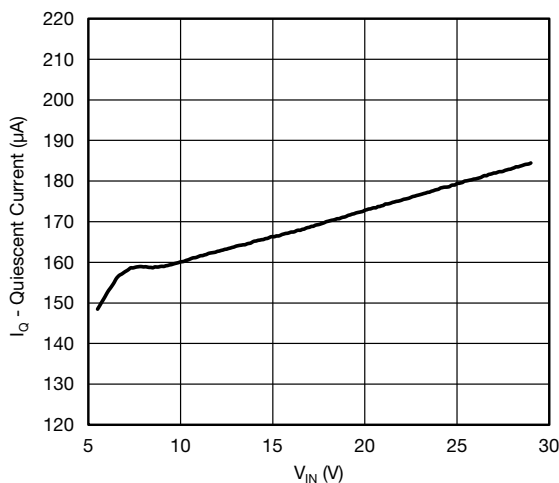
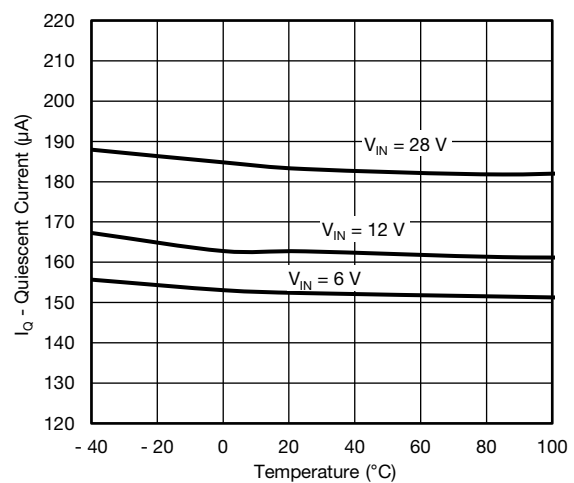


Fig. 3 - DFN10 3 mm x 3 mm Package
Top View

PIN DESCRIPTION		
PIN NUMBER	NAME	FUNCTION
1	V_{IN}	Power input
2	V_{IN}	Power input
3	SS	Soft-start pin. Connect a capacitor from SS to GND to program the soft-start time. Leave SS open to set the default soft-start time of 400 μ s
4	EN	Enable input. Logic high enabled
5	I_{LIM}	Current limit setting pin. Connect R_{SET} resistor to GND
6	GND	Ground
7	\overline{PG}	Power good
8	\overline{FLG}	Fault condition flag
9	V_{OUT}	Switch output
10	V_{OUT}	Switch output
Central pad		Connect this pad to GND or leave it floating

BLOCK DIAGRAM

Fig. 4 - Block Diagram
TYPICAL CHARACTERISTICS (internally regulated, 25 °C, unless otherwise noted)

Fig. 5 - Quiescent Current vs. Input Voltage

Fig. 6 - Quiescent Current vs. Temperature

TYPICAL CHARACTERISTICS (internally regulated, 25 °C, unless otherwise noted)

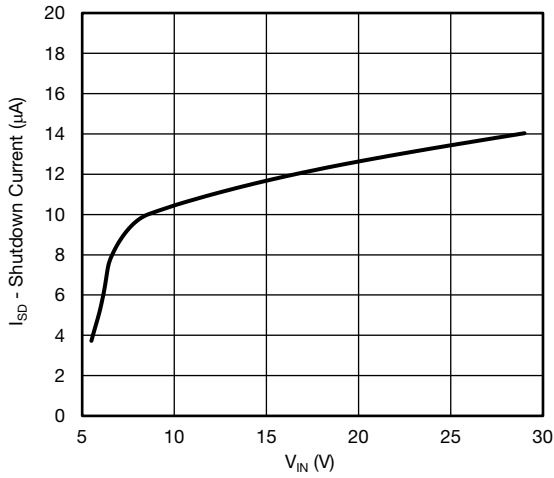


Fig. 7 - Shutdown Current vs. Input Voltage

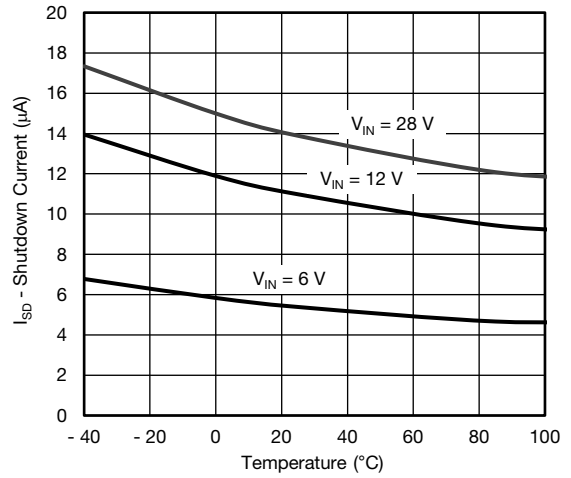


Fig. 10 - Shutdown Current vs. Temperature

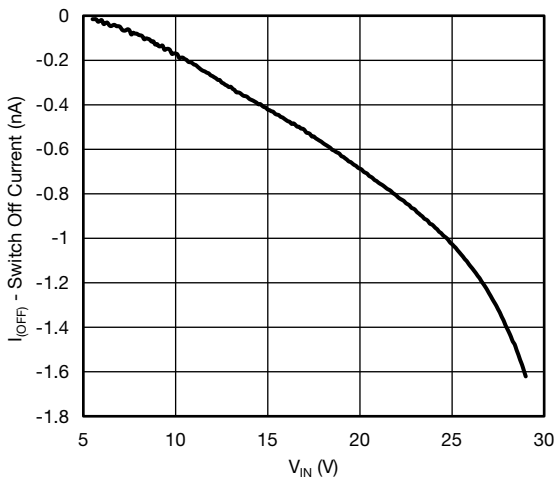


Fig. 8 - Shutdown Current vs. Input Voltage

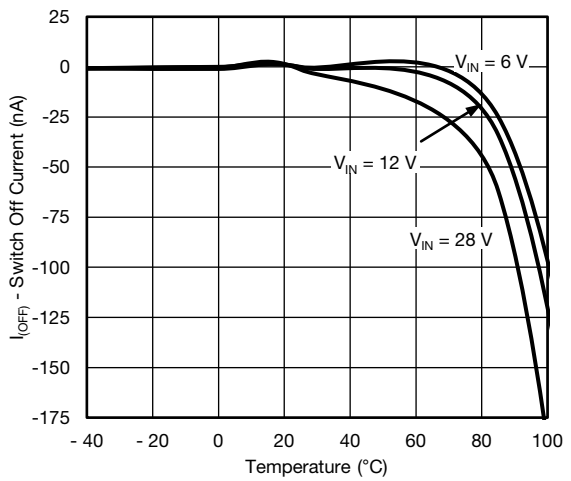


Fig. 11 - Switch Off Current vs. Temperature

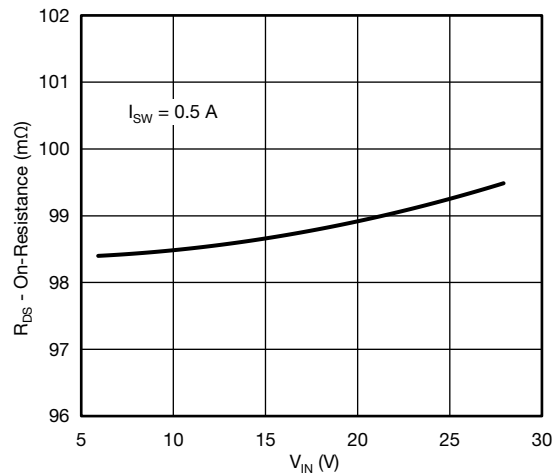


Fig. 9 - On Resistance vs. Input Voltage

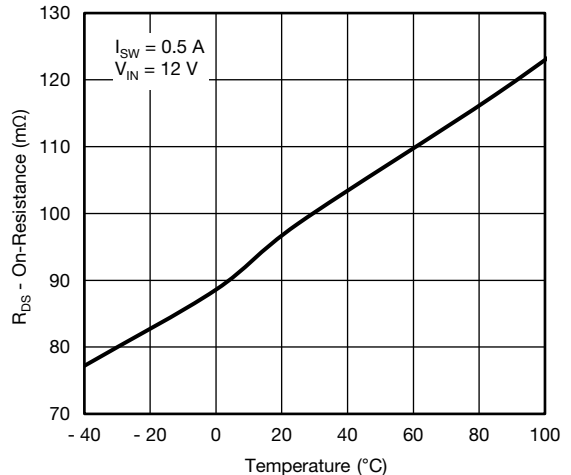


Fig. 12 - On Resistance vs. Temperature

TYPICAL CHARACTERISTICS (internally regulated, 25 °C, unless otherwise noted)

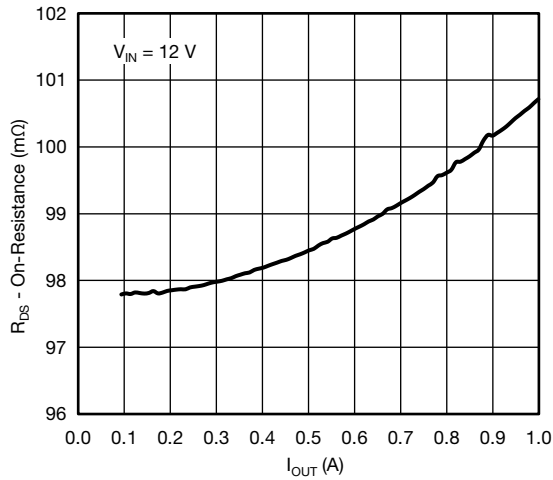


Fig. 13 - On Resistance vs. Output Current

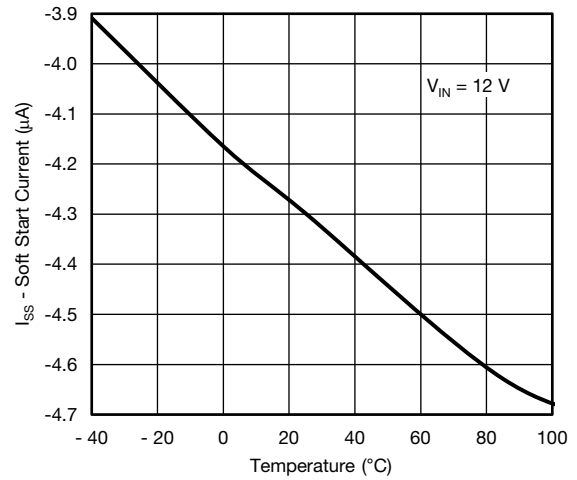


Fig. 16 - Soft Start Current vs. Temperature

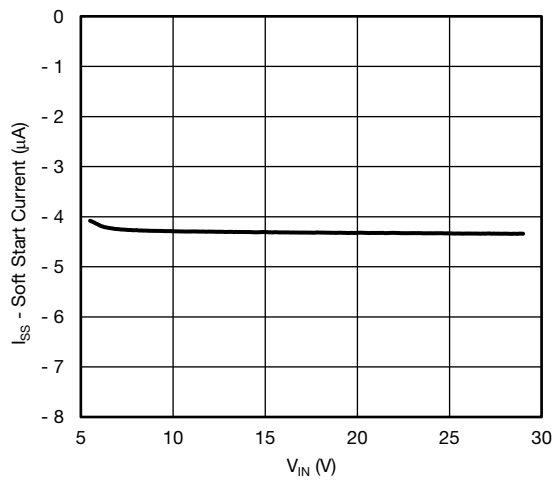


Fig. 14 - Soft Start Current vs. Input Voltage

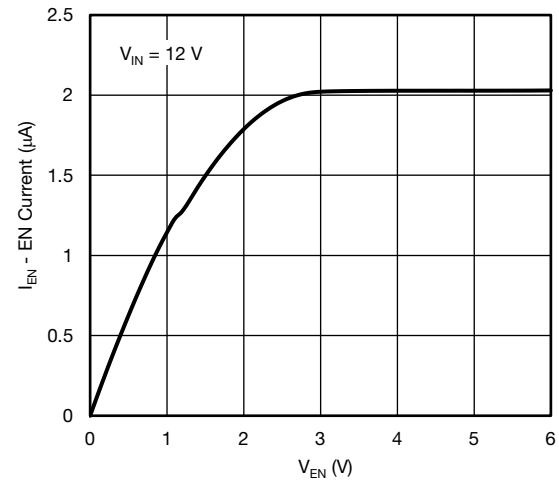


Fig. 17 - EN Current vs. V_{EN}

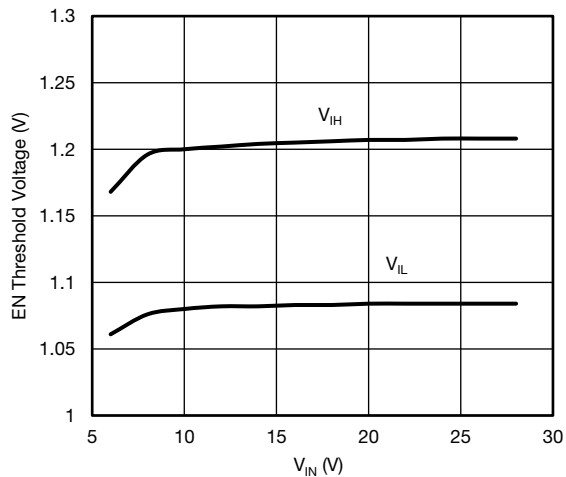


Fig. 15 - Threshold Voltage vs. Input Voltage



TYPICAL CHARACTERISTICS (internally regulated, 25 °C, unless otherwise noted)

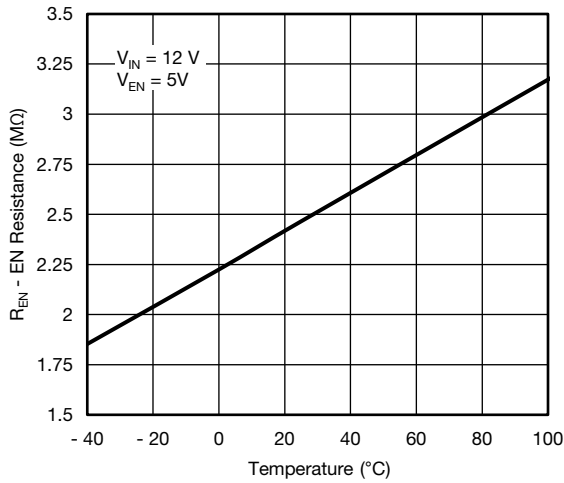


Fig. 18 - EN Resistance vs. Temperature

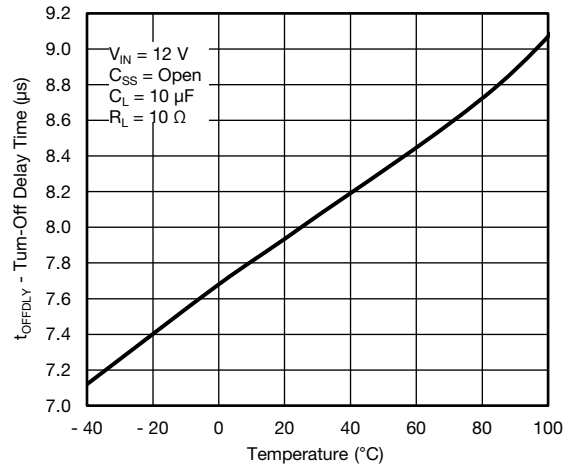


Fig. 21 - Turn-Off Delay Time vs. Temperature

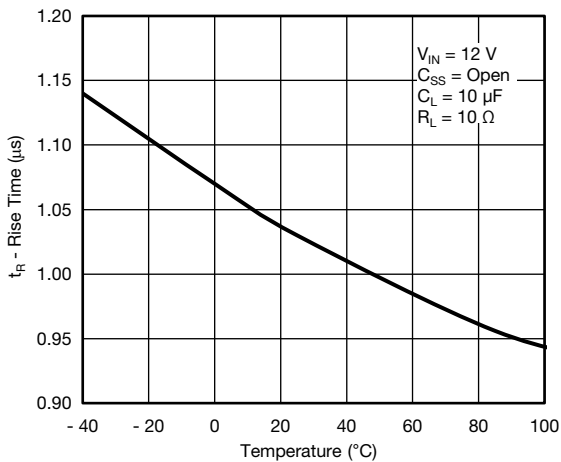


Fig. 19 - Rise Time vs. Temperature

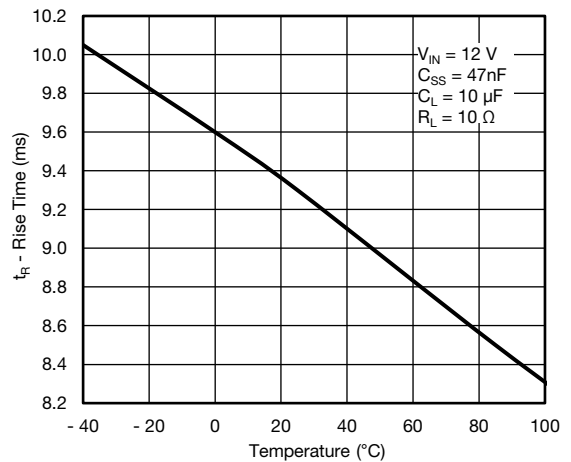


Fig. 22 - Rise Time vs. Temperature

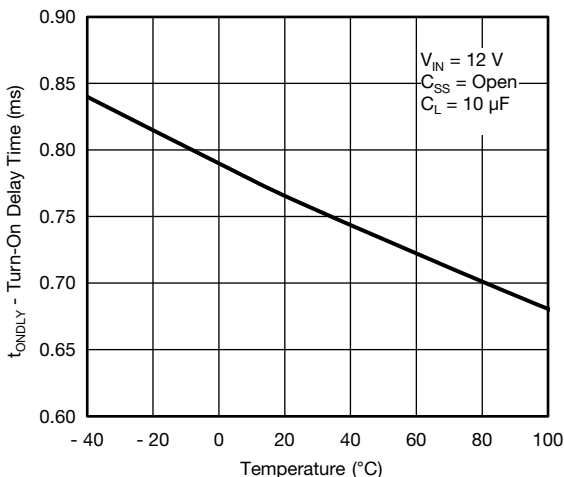


Fig. 20 - Turn-On Delay Time vs. Temperature

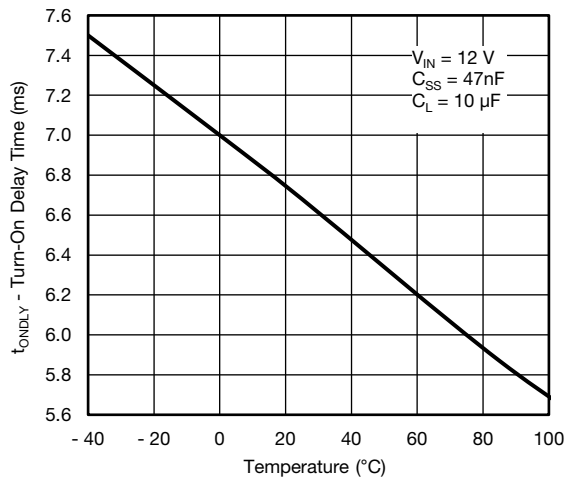


Fig. 23 - Turn-On Delay Time vs. Temperature

TYPICAL WAVEFORMS

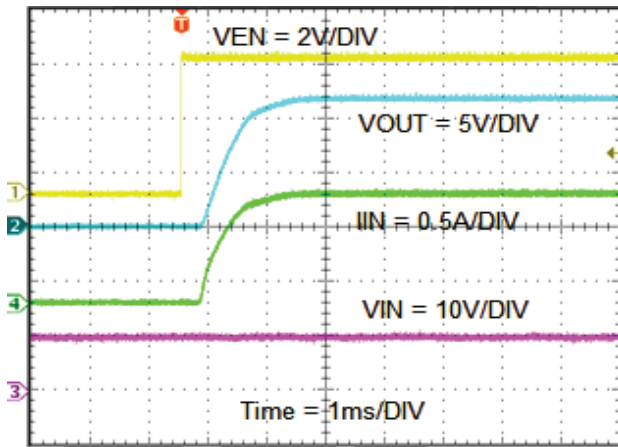


Fig. 24 - Turn-On Time,
 $V_{IN} = 12\text{ V}$, $C_{SS} = \text{open}$, $R_L = 10\ \Omega$, $C_L = 10\ \mu\text{F}$

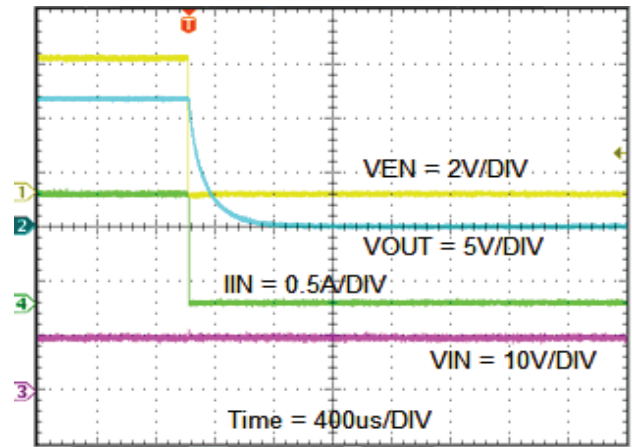


Fig. 27 - Turn-Off Time,
 $V_{IN} = 12\text{ V}$, $C_{SS} = \text{open}$, $R_L = 10\ \Omega$, $C_L = 10\ \mu\text{F}$

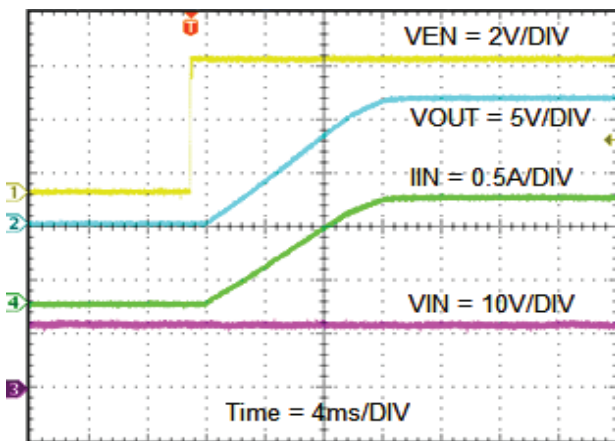


Fig. 25 - Turn-On Time,
 $V_{IN} = 12\text{ V}$, $C_{SS} = 47\text{ nF}$, $R_L = 10\ \Omega$, $C_L = 10\ \mu\text{F}$

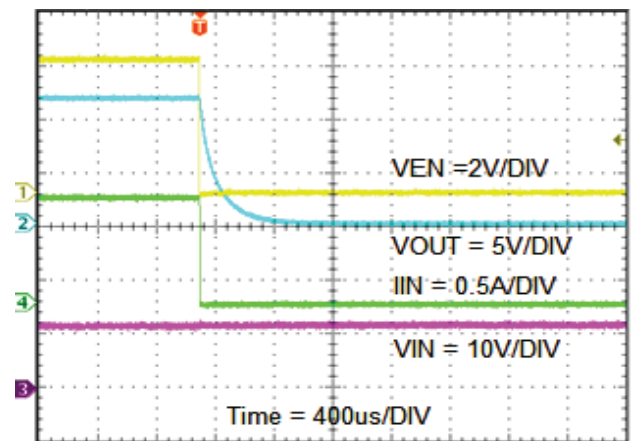


Fig. 28 - Turn-Off Time,
 $V_{IN} = 12\text{ V}$, $C_{SS} = 47\text{ nF}$, $R_L = 10\ \Omega$, $C_L = 10\ \mu\text{F}$

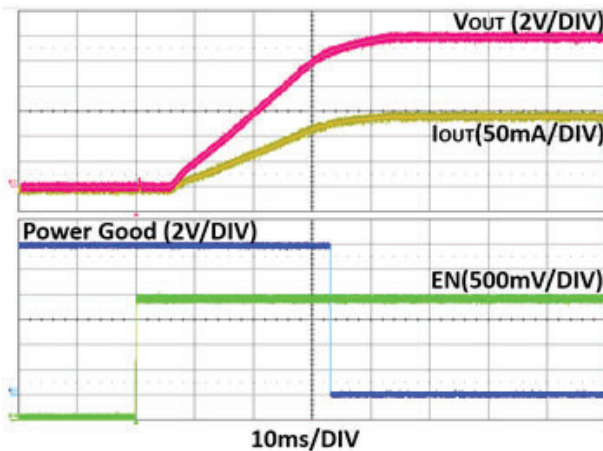


Fig. 26 - $V_{IN} = 12\text{ V}$, $R_L = 82\ \Omega$, $R_{SET} = 16.2\text{ k}\Omega$,
 $C_{SS} = 150\text{ nF}$, $C_{OUT} = \text{open}$

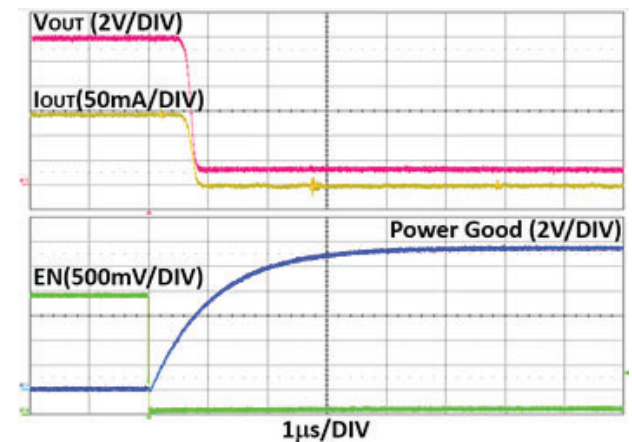


Fig. 29 - $V_{IN} = 12\text{ V}$, $R_L = 82\ \Omega$, $R_{SET} = 16.2\text{ k}\Omega$,
 $C_{SS} = 150\text{ nF}$, $C_{OUT} = \text{open}$

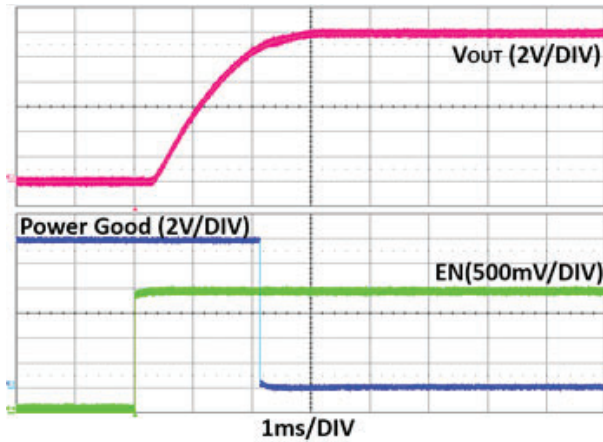
TYPICAL WAVEFORMS


Fig. 30 - $V_{IN} = 12\text{ V}$, $R_L = \text{open}$, $R_{SET} = 16.2\text{ k}\Omega$,
 $C_{SS} = 150\text{ nF}$, $C_{OUT} = \text{open}$

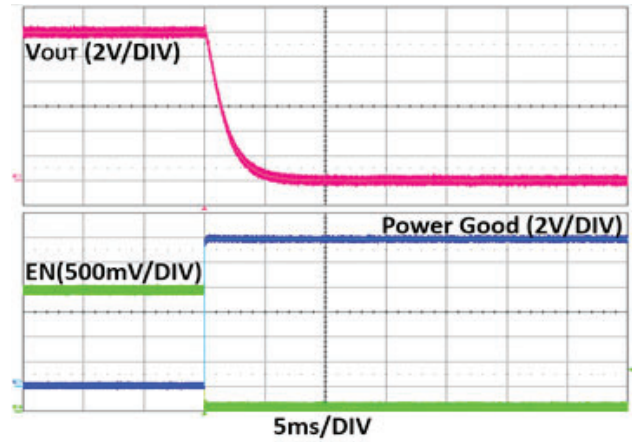


Fig. 33 - $V_{IN} = 12\text{ V}$, $R_L = \text{open}$, $R_{SET} = 16.2\text{ k}\Omega$,
 $C_{SS} = 150\text{ nF}$, $C_{OUT} = \text{open}$

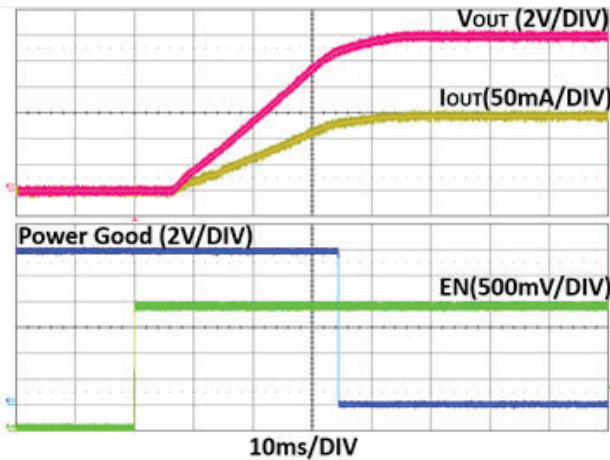


Fig. 31 - $V_{IN} = 12\text{ V}$, $R_L = 82\ \Omega$, $R_{SET} = 16.2\text{ k}\Omega$,
 $C_{SS} = 150\text{ nF}$, $C_{OUT} = 10\ \mu\text{F}$

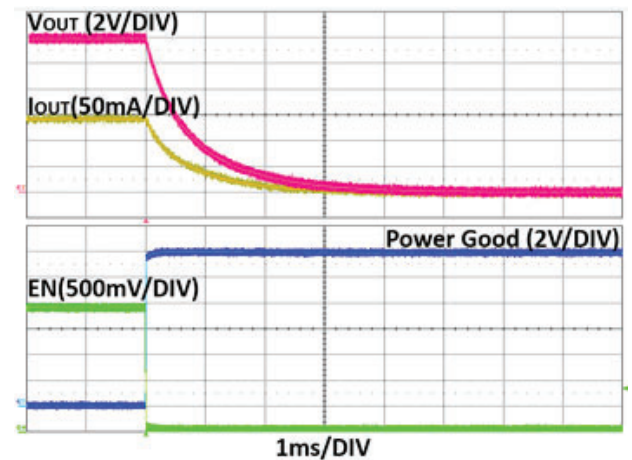


Fig. 34 - $V_{IN} = 12\text{ V}$, $R_L = 82\ \Omega$, $R_{SET} = 16.2\text{ k}\Omega$,
 $C_{SS} = 150\text{ nF}$, $C_{OUT} = 10\ \mu\text{F}$

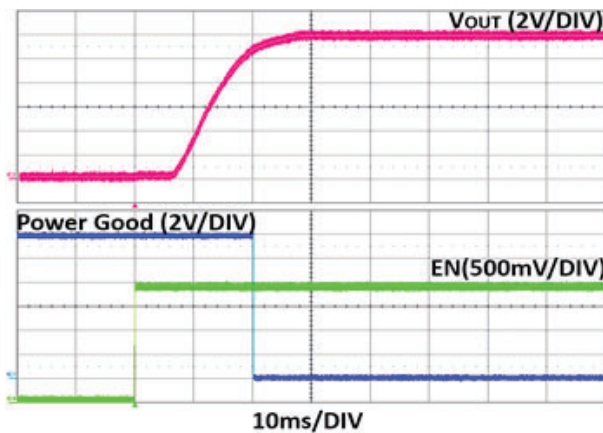


Fig. 32 - $V_{IN} = 12\text{ V}$, $R_L = \text{open}$, $R_{SET} = 16.2\text{ k}\Omega$,
 $C_{SS} = 150\text{ nF}$, $C_{OUT} = 10\ \mu\text{F}$

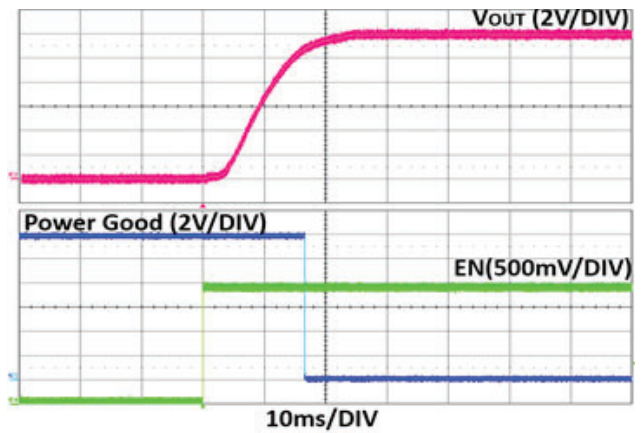


Fig. 35 - $V_{IN} = 12\text{ V}$, $R_L = \text{open}$, $R_{SET} = 3.32\text{ k}\Omega$,
 $C_{SS} = 150\text{ nF}$, $C_{OUT} = 10\ \mu\text{F}$

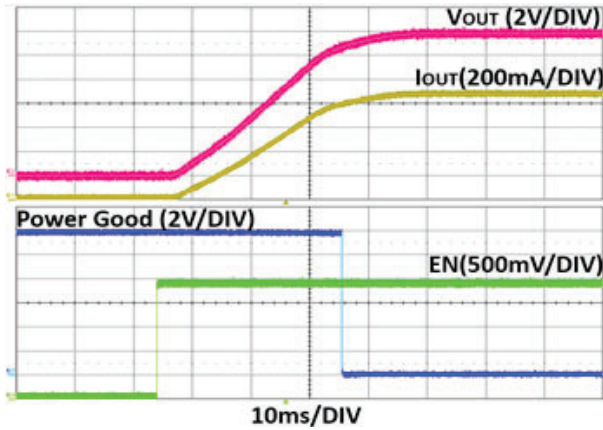
TYPICAL WAVEFORMS


Fig. 36 - $V_{IN} = 12\text{ V}$, $R_L = 14\ \Omega$, $R_{SET} = 3.32\text{ k}\Omega$, $C_{SS} = 150\text{ nF}$, $C_{OUT} = \text{open}$

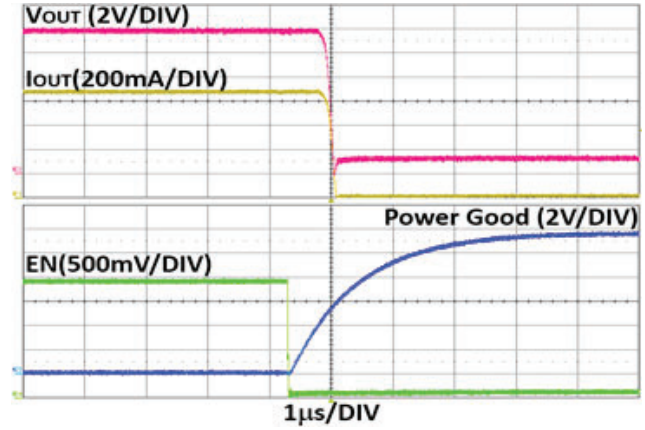


Fig. 39 - $V_{IN} = 12\text{ V}$, $R_L = 14\ \Omega$, $R_{SET} = 3.32\text{ k}\Omega$, $C_{SS} = 150\text{ nF}$, $C_{OUT} = \text{open}$

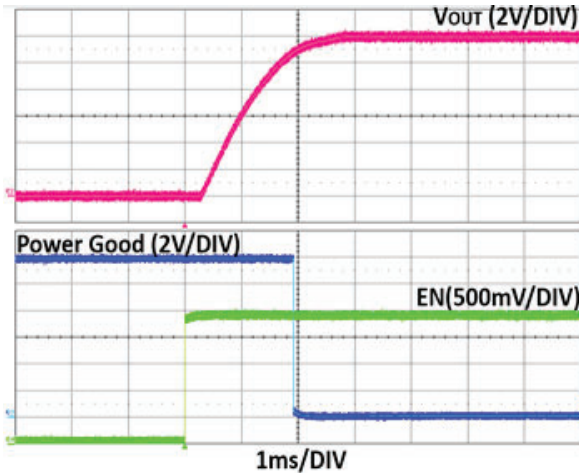


Fig. 37 - $V_{IN} = 12\text{ V}$, $R_L = \text{open}$, $R_{SET} = 3.32\text{ k}\Omega$, $C_{SS} = 150\text{ nF}$, $C_{OUT} = \text{open}$

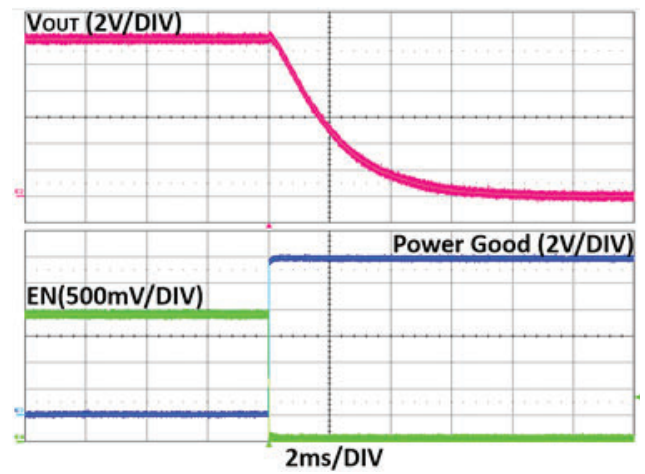


Fig. 40 - $V_{IN} = 12\text{ V}$, $R_L = \text{open}$, $R_{SET} = 3.32\text{ k}\Omega$, $C_{SS} = 150\text{ nF}$, $C_{OUT} = \text{open}$

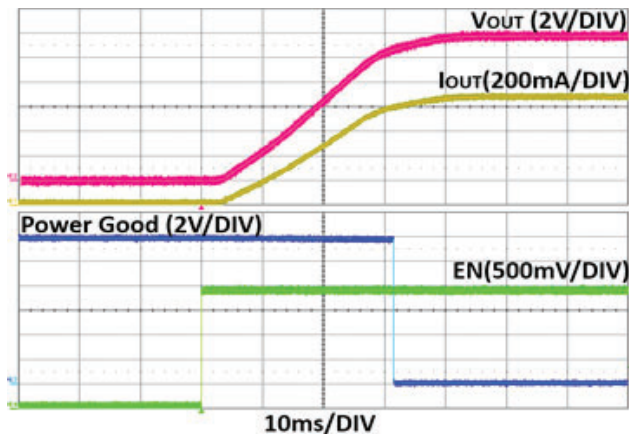


Fig. 38 - $V_{IN} = 12\text{ V}$, $R_L = 14\ \Omega$, $R_{SET} = 3.32\text{ k}\Omega$, $C_{SS} = 150\text{ nF}$, $C_{OUT} = 10\ \mu\text{F}$

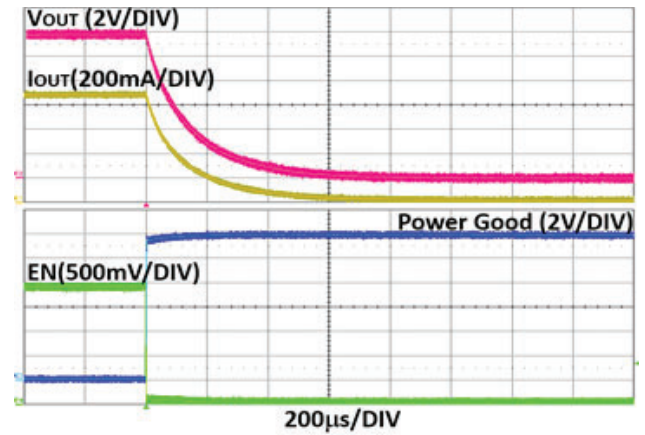


Fig. 41 - $V_{IN} = 12\text{ V}$, $R_L = 14\ \Omega$, $R_{SET} = 3.32\text{ k}\Omega$, $C_{SS} = 150\text{ nF}$, $C_{OUT} = 10\ \mu\text{F}$

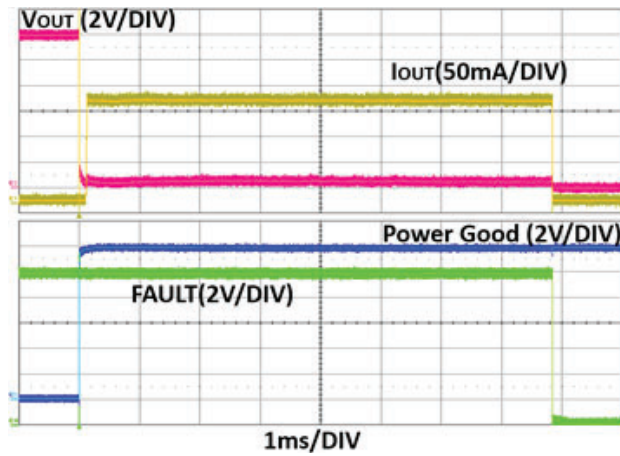
TYPICAL WAVEFORMS


Fig. 42 - $V_{IN} = 12\text{ V}$, $R_L = \text{open to } 2\ \Omega$, $R_{SET} = 16.2\ \text{k}\Omega$, $C_{SS} = 150\ \text{nF}$, $C_{OUT} = \text{open}$

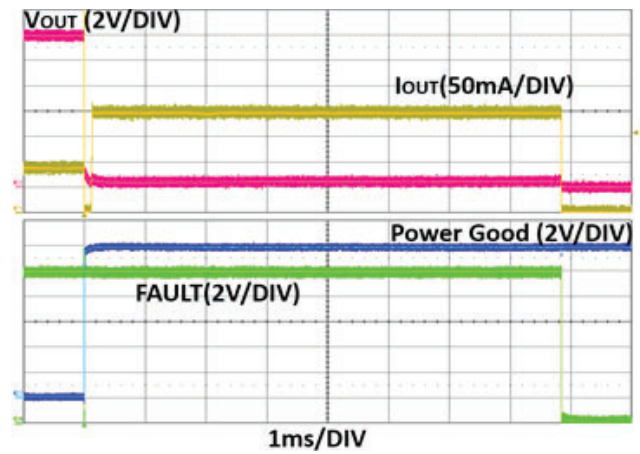


Fig. 45 - $V_{IN} = 12\text{ V}$, $R_L = 136\ \Omega \text{ to } 2\ \Omega$, $R_{SET} = 16.2\ \text{k}\Omega$, $C_{SS} = 150\ \text{nF}$, $C_{OUT} = \text{open}$

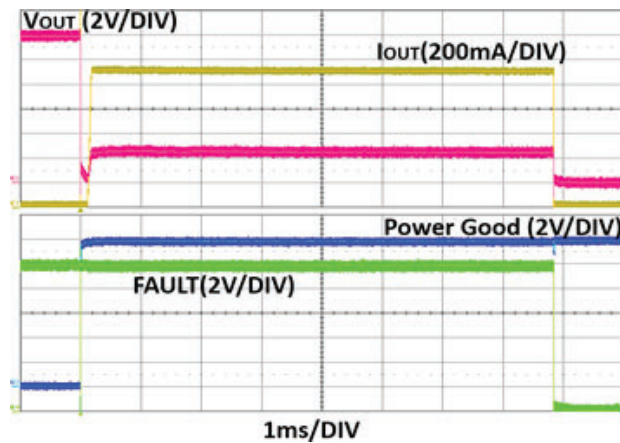


Fig. 43 - $V_{IN} = 12\text{ V}$, $R_L = \text{open to } 2\ \Omega$, $R_{SET} = 3.32\ \text{k}\Omega$, $C_{SS} = 150\ \text{nF}$, $C_{OUT} = \text{open}$

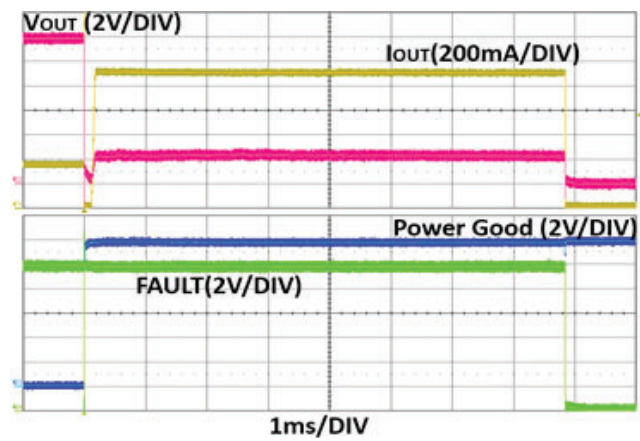


Fig. 46 - $V_{IN} = 12\text{ V}$, $R_L = 34\ \Omega \text{ to } 2\ \Omega$, $R_{SET} = 3.32\ \text{k}\Omega$, $C_{SS} = 150\ \text{nF}$, $C_{OUT} = \text{open}$

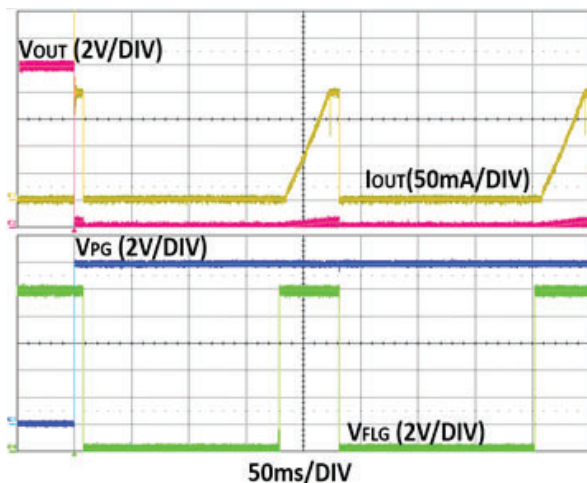


Fig. 44 - $V_{IN} = 12\text{ V}$, $R_L = 2\ \Omega$, $R_{SET} = 16.2\ \text{k}\Omega$, $C_{SS} = 150\ \text{nF}$, $C_{OUT} = 10\ \mu\text{F}$, Re-Starts after $\sim 150\ \text{ms}$ during Fault Condition

DETAILED DESCRIPTION

Over Current Limit

When an over-current event occurs, the SiP32430 will limit the current immediately. If the event exceeds 7 ms, the SiP32430 will turn off the switch. The FLG pin is pulled low upon the switch off. The SiP32430 will auto restart 150 ms after the switch off and the recovery from over temperature. The SiP32430 current limit is set an external resistor between the I_{LIM} pin and GND. R_{SET} can be selected per the following table and curve.

R _{SET} SELECTION TABLE					
R _{SET} (kΩ)	CURRENT LIMIT (A) (SETTLING)			TOL. (%)	CURRENT LIMIT TRIGGER POINT (A)
	MIN.	TYP.	MAX.		TYP.
4.22	0.81	1.01	1.21	20	1.12
5.36	0.65	0.81	0.97	20	0.87
7.15	0.49	0.61	0.73	20	0.66
10.2	0.33	0.42	0.50	20	0.46
12	0.28	0.35	0.42	20	0.38
13.3	0.25	0.31	0.37	20	0.35
18.7	0.17	0.21	0.26	20	0.25
24.3	0.11	0.16	0.21	30	0.19

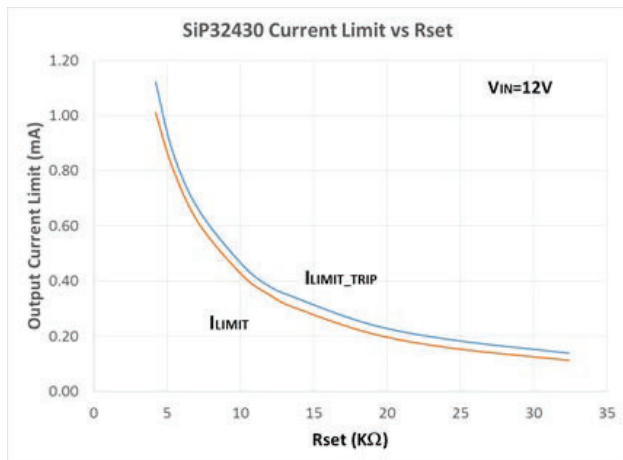


Fig. 47 - Current Limit vs. R_{SET}

The current limit trigger level is typically 8 % over the current limit setting current.

Soft Start

The soft start time can be calculated by the following formula:

$$\frac{\Delta V_{OUT}}{\Delta t} = \frac{I_{SS}}{C_{SS}} \times \frac{R_{OUT} \times 3300}{R_{SET}}$$

Where:

Δt is the soft start time

ΔV_{OUT} is the output voltage range

I_{SS} is the built-in current source charging the soft start capacitor C_{SS}. I_{SS} value is 5 μA typical.

C_{SS} is the soft start time setting capacitor.

R_{SET} is the current limit setting resistor.

R_{OUT} is the output load.

Enable

The device is logic high enable. This can be accomplished by applying a logic high signal to the EN pin. Alternatively this pin can be hardwired through a resistor divider to the V_{IN}, thus keeping the switch permanently ON as long as the supply is present.

FLG

The FLG is an open drain output and will be pulled low under over temperature or over current conditions.

PG

The PG is an open drain output that will be pulled low when output voltage reaches 90 % of the V_{IN}.

APPLICATION INFORMATION

Input Capacitor

While bypass capacitors at the inputs pins are not required, a 2.2 μ F or larger capacitors for C_{IN} is recommended in almost all applications. The bypass capacitors should be placed as physically close to the device's input pins to be effective to minimize transients on the input. Ceramic capacitors are recommended over tantalum because of their ability to withstand input current surges from low impedance sources such as batteries.

Output Capacitor

SiP32430 does not require an output capacitor for proper operation. A proper value C_{OUT} is recommended to accommodate load transient per circuit design requirements. There are no specific ESR or capacitor type requirements.

Over Temperature Shutdown

In case an over temperature event happens, the SiP32430 will turn the switch off immediately. The SiP32430 will then retry to start 150 ms after the temperature is back to normal; during this period, \overline{FLG} will be pulled low. The SiP32430 \overline{FLG} will be pulled high 150 ms after the OT event has finished.

Thermal Consideration

SiP32430 is designed to maintain a constant output load current under over current event. Due to physical limitations of the layout and assembly of the device, the maximum switch current should be kept at reasonably safe level within the range of SOA. However, another limiting characteristic of the safe operating load current is the power dissipation. The power dissipation need to be considered in the layout design to reduce the device temperature.

SOA

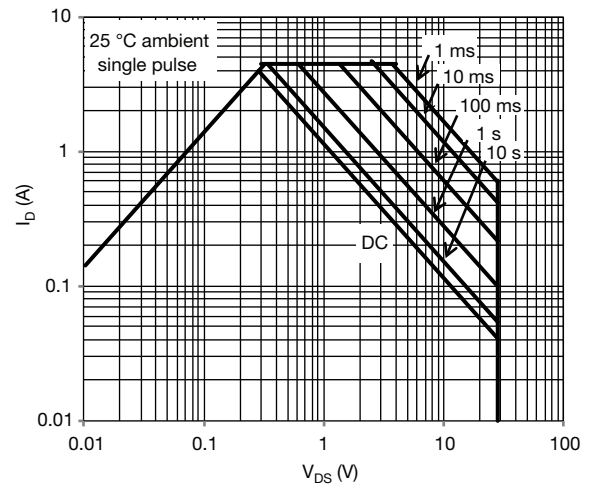


Fig. 48 - SOA on Application Board

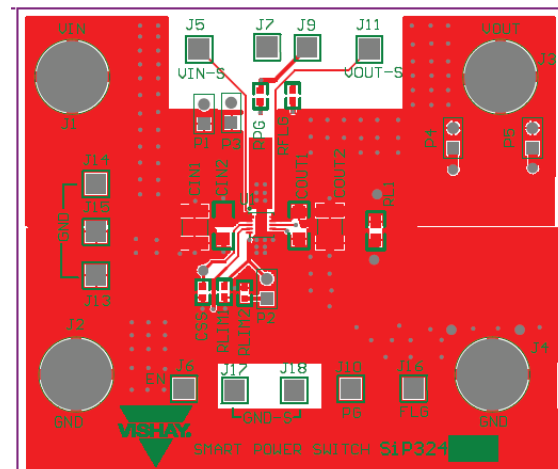


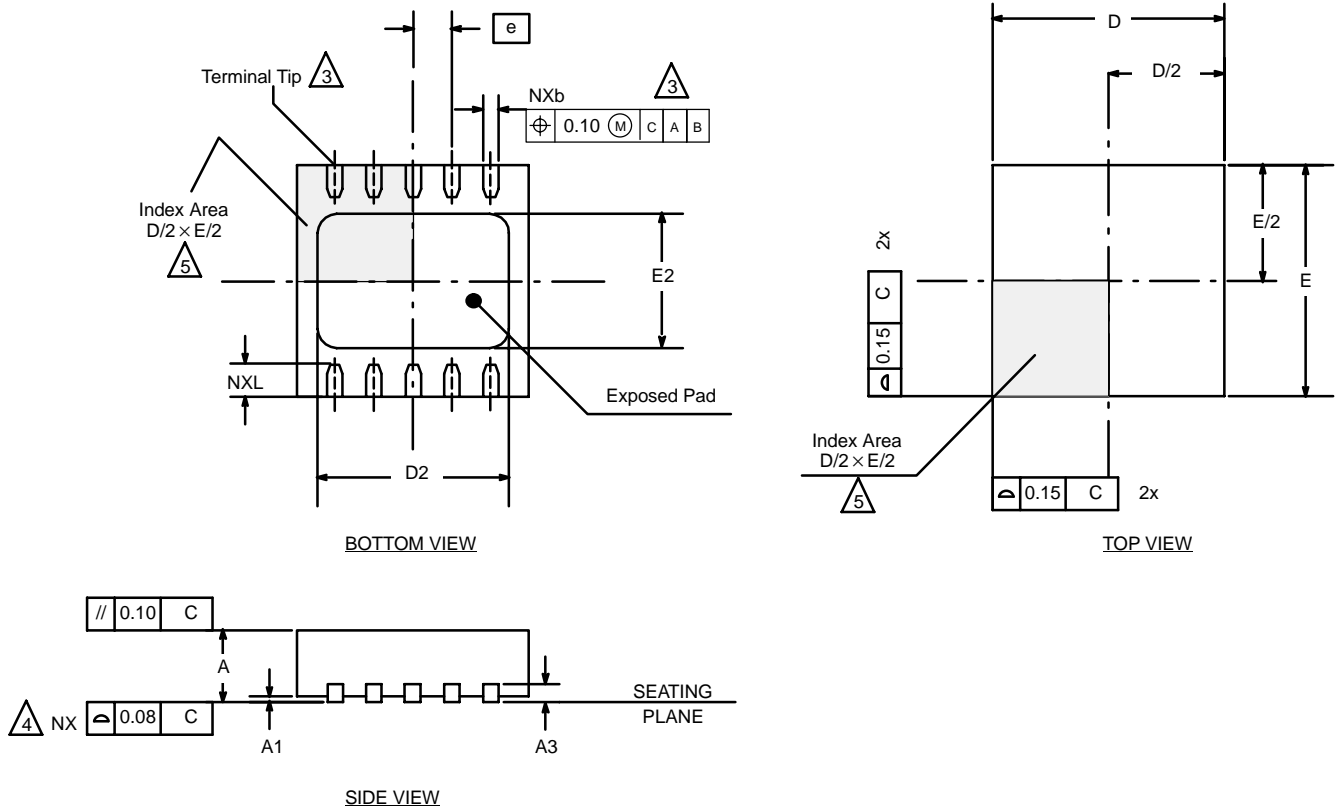
Fig. 49 - Application Board Layout



PRODUCT SUMMARY	
Part number	SiP32430
Description	6 V to 28 V, 99 mΩ, programmable current limit and slew rate, auto retry on fault
Configuration	Single
Slew rate time (μs)	Adjustable
On delay time (μs)	80
Input voltage min. (V)	6
Input voltage max. (V)	28
On-resistance at input voltage min. (mΩ)	99
On-resistance at input voltage max. (mΩ)	99
Quiescent current at input voltage min. (μA)	148
Quiescent current at input voltage max. (μA)	185
Output discharge (yes / no)	No
Reverse blocking (yes / no)	No
Continuous current (A)	3.2
Current limit min. (A)	0.1
Current limit max. (A)	1.0
Absolute maximum input voltage (V)	30
Package type	DFN33-10L
Package size (W, L, H) (mm)	3.0 x 3.0 x 0.9
Status code	2
Product type	Slew rate, current limit
Applications	Computers, consumer, industrial, healthcare, networking, portable

Vishay Siliconix maintains worldwide manufacturing capability. Products may be manufactured at one of several qualified locations. Reliability data for Silicon Technology and Package Reliability represent a composite of all qualified locations. For related documents such as package/tape drawings, part marking, and reliability data, see www.vishay.com/ppg?65223.

DFN-10 LEAD (3 X 3)



NOTES:

- All dimensions are in millimeters and inches.
- N is the total number of terminals.
- $\triangle 3$ Dimension b applies to metallized terminal and is measured between 0.15 and 0.30 mm from terminal tip.
- $\triangle 4$ Coplanarity applies to the exposed heat sink slug as well as the terminal.
- $\triangle 5$ The pin #1 identifier may be either a mold or marked feature, it must be located within the zone indicated.

Dim	MILLIMETERS			INCHES		
	Min	Nom	Max	Min	Nom	Max
A	0.80	0.90	1.00	0.031	0.035	0.039
A1	0.00	0.02	0.05	0.000	0.001	0.002
A3	0.20 BSC			0.008 BSC		
b	0.18	0.23	0.30	0.007	0.009	0.012
D	3.00 BSC			0.118 BSC		
D2	2.20	2.38	2.48	0.087	0.094	0.098
E	3.00 BSC			0.118 BSC		
E2	1.49	1.64	1.74	0.059	0.065	0.069
e	0.50 BSC			0.020 BSC		
L	0.30	0.40	0.50	0.012	0.016	0.020
*Use millimeters as the primary measurement.						
ECN: S-42134—Rev. A, 29-Nov-04						
DWG: 5943						



Disclaimer

ALL PRODUCT, PRODUCT SPECIFICATIONS AND DATA ARE SUBJECT TO CHANGE WITHOUT NOTICE TO IMPROVE RELIABILITY, FUNCTION OR DESIGN OR OTHERWISE.

Vishay Intertechnology, Inc., its affiliates, agents, and employees, and all persons acting on its or their behalf (collectively, "Vishay"), disclaim any and all liability for any errors, inaccuracies or incompleteness contained in any datasheet or in any other disclosure relating to any product.

Vishay makes no warranty, representation or guarantee regarding the suitability of the products for any particular purpose or the continuing production of any product. To the maximum extent permitted by applicable law, Vishay disclaims (i) any and all liability arising out of the application or use of any product, (ii) any and all liability, including without limitation special, consequential or incidental damages, and (iii) any and all implied warranties, including warranties of fitness for particular purpose, non-infringement and merchantability.

Statements regarding the suitability of products for certain types of applications are based on Vishay's knowledge of typical requirements that are often placed on Vishay products in generic applications. Such statements are not binding statements about the suitability of products for a particular application. It is the customer's responsibility to validate that a particular product with the properties described in the product specification is suitable for use in a particular application. Parameters provided in datasheets and / or specifications may vary in different applications and performance may vary over time. All operating parameters, including typical parameters, must be validated for each customer application by the customer's technical experts. Product specifications do not expand or otherwise modify Vishay's terms and conditions of purchase, including but not limited to the warranty expressed therein.

Except as expressly indicated in writing, Vishay products are not designed for use in medical, life-saving, or life-sustaining applications or for any other application in which the failure of the Vishay product could result in personal injury or death. Customers using or selling Vishay products not expressly indicated for use in such applications do so at their own risk. Please contact authorized Vishay personnel to obtain written terms and conditions regarding products designed for such applications.

No license, express or implied, by estoppel or otherwise, to any intellectual property rights is granted by this document or by any conduct of Vishay. Product names and markings noted herein may be trademarks of their respective owners.

Mouser Electronics

Authorized Distributor

Click to View Pricing, Inventory, Delivery & Lifecycle Information:

Vishay:

[SIP32430DN-T1-GE4](#)