

## Fast Recovery Diodes (Hockey PUK Version), 990 A

**K-PUK (DO-200AC)**

**RoHS  
COMPLIANT**
**FEATURES**

- High power fast recovery diode series
- 5.0  $\mu$ s recovery time
- High voltage ratings up to 4500 V
- High current capability
- Optimized turn-on and turn-off characteristics
- Low forward recovery
- Fast and soft reverse recovery
- Press PUK encapsulation
- Case style conform to JEDEC® K-PUK (DO-200AC)
- Maximum junction temperature 125 °C
- Designed and qualified for industrial level
- Material categorization: for definitions of compliance please see [www.vishay.com/doc?99912](http://www.vishay.com/doc?99912)

**TYPICAL APPLICATIONS**

- Snubber diode for GTO
- High voltage freewheeling diode
- Fast recovery rectifier applications

**PRIMARY CHARACTERISTICS**

$I_{F(AV)}$	990 A
Package	K-PUK (DO-200AC)
Circuit configuration	Single

**MAJOR RATINGS AND CHARACTERISTICS**

PARAMETER	TEST CONDITIONS	VALUES	UNITS
$I_{F(AV)}$		990	A
	$T_{hs}$	55	°C
$I_{F(RMS)}$		1800	A
	$T_{hs}$	25	°C
$I_{FSM}$	50 Hz	19 000	A
	60 Hz	19 900	
$I^2t$	50 Hz	1810	kA <sup>2</sup> s
	60 Hz	1652	
$V_{RRM}$	Range	3000 to 4500	V
$t_{rr}$		5.0	$\mu$ s
	$T_J$	25	°C
$T_J$		-40 to +125	

**ELECTRICAL SPECIFICATIONS**
**VOLTAGE RATINGS**

TYPE NUMBER	VOLTAGE CODE	$V_{RRM}$ , MAXIMUM REPETITIVE PEAK REVERSE VOLTAGE V	$V_{RSM}$ , MAXIMUM NON-REPETITIVE PEAK REVERSE VOLTAGE V	$I_{RRM}$ MAXIMUM AT $T_J = 125$ °C mA
VS-SD853C..S50K	30	3000	3100	100
	36	3600	3700	
	40	4000	4100	
	45	4500	4600	



FORWARD CONDUCTION					
PARAMETER	SYMBOL	TEST CONDITIONS		VALUES	UNITS
Maximum average forward current at heatsink temperature	$I_{F(AV)}$	180° conduction, half sine wave Double side (single side) cooled		990 (420)	A
				55 (85)	°C
Maximum RMS forward current	$I_{F(RMS)}$	25 °C heatsink temperature double side cooled		1800	
Maximum peak, one-cycle forward, non-repetitive surge current	$I_{FSM}$	t = 10 ms t = 8.3 ms	No voltage reappplied	19 000	A
				t = 10 ms t = 8.3 ms	
		t = 10 ms t = 8.3 ms	50 % $V_{RRM}$ reappplied		
				t = 10 ms t = 8.3 ms	
Maximum $I^2t$ for fusing	$I^2t$	t = 10 ms t = 8.3 ms	No voltage reappplied		1805
				t = 10 ms t = 8.3 ms	50 % $V_{RRM}$ reappplied
		t = 10 ms t = 8.3 ms	50 % $V_{RRM}$ reappplied		
				t = 10 ms t = 8.3 ms	50 % $V_{RRM}$ reappplied
Maximum $I^2\sqrt{t}$ for fusing	$I^2\sqrt{t}$	t = 0.1 to 10 ms, no voltage reappplied			
Low level value of threshold voltage	$V_{F(TO)1}$	(16.7 % $\times \pi \times I_{F(AV)} < I < \pi \times I_{F(AV)}$ , $T_J = T_J$ maximum)		1.50	V
High level value of threshold voltage	$V_{F(TO)2}$	(I > $\pi \times I_{F(AV)}$ , $T_J = T_J$ maximum)		1.67	
Low level value of forward slope resistance	$r_{f1}$	(16.7 % $\times \pi \times I_{F(AV)} < I < \pi \times I_{F(AV)}$ , $T_J = T_J$ maximum)		0.70	mW
High level value of forward slope resistance	$r_{f2}$	(I > $\pi \times I_{F(AV)}$ , $T_J = T_J$ maximum)		0.65	
Maximum forward voltage drop	$V_{FM}$	$I_{pk} = 2000$ A, $T_J = 125$ °C; $t_p = 10$ ms sinusoidal wave		2.90	V

RECOVERY CHARACTERISTICS								
CODE	MAXIMUM VALUE AT $T_J = 25$ °C	TEST CONDITIONS			TYPICAL VALUES AT $T_J = 125$ °C			
	$t_{rr}$ at 25 % $I_{RRM}$ (μs)	$I_{pk}$ SQUARE PULSE (A)	dI/dt (A/μs)	$V_r$ (V)	$t_{rr}$ at 25 % $I_{RRM}$ (μs)	$Q_{rr}$ (μC)	$I_{rr}$ (A)	
S50	5.0	1000	100	-50	6.5	1000	270	

THERMAL AND MECHANICAL SPECIFICATIONS				
PARAMETER	SYMBOL	TEST CONDITIONS	VALUES	UNITS
Maximum junction operating temperature range	$T_J$		-40 to +125	°C
Maximum storage temperature range	$T_{Stg}$		-40 to +150	
Maximum thermal resistance, junction to heatsink	$R_{thJ-hs}$	DC operation single side cooled	0.04	K/W
		DC operation double side cooled	0.02	
Mounting force, ± 10 %			22 250 (2250)	N (kg)
Approximate weight			425	g
Case style		See dimensions - link at the end of datasheet	K-PUK (DO-200AC)	

$\Delta R_{thJ-hs}$ CONDUCTION						
CONDUCTION ANGLE	SINUSOIDAL CONDUCTION		RECTANGULAR CONDUCTION		TEST CONDITIONS	UNITS
	SINGLE SIDE	DOUBLE SIDE	SINGLE SIDE	DOUBLE SIDE		
180°	0.0017	0.0019	0.0012	0.0012	$T_J = T_J$ maximum	K/W
120°	0.0021	0.0021	0.0021	0.0021		
90°	0.0026	0.0027	0.0029	0.0029		
60°	0.039	0.0039	0.0041	0.0041		
30°	0.0067	0.0067	0.0068	0.0068		

Note

- The table above shows the increment of thermal resistance  $R_{thJ-hs}$  when devices operate at different conduction angles than DC

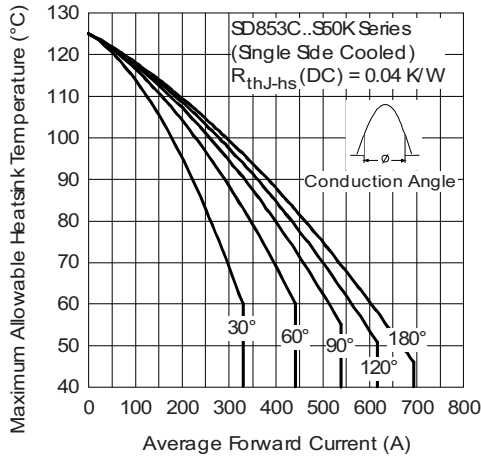

Fig. 1 - Current Ratings Characteristics

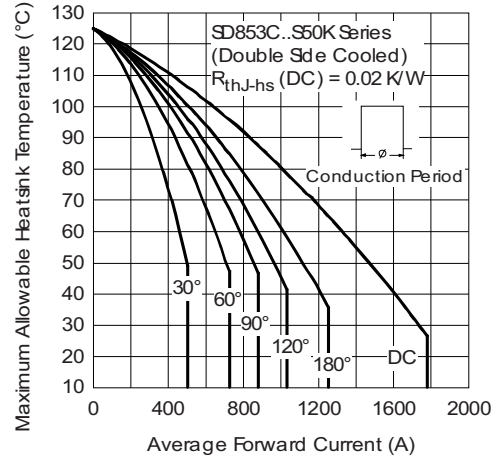

Fig. 4 - Current Ratings Characteristics

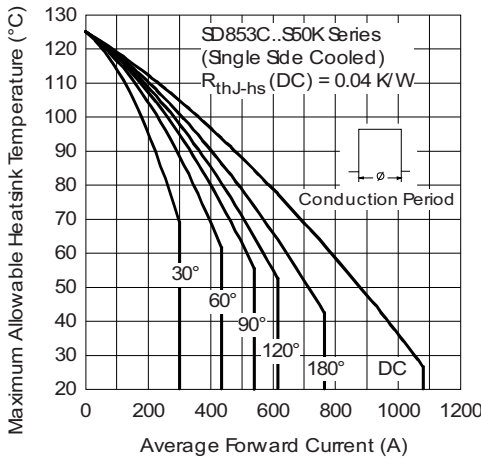

Fig. 2 - Current Ratings Characteristics

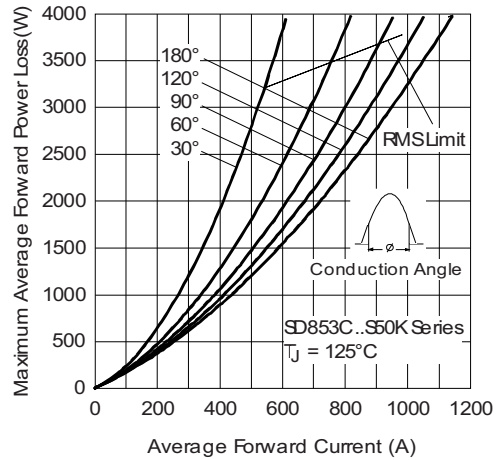

Fig. 5 - Forward Power Loss Characteristics

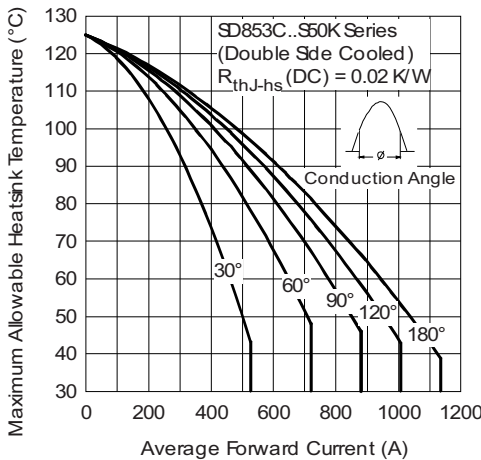

Fig. 3 - Current Ratings Characteristics

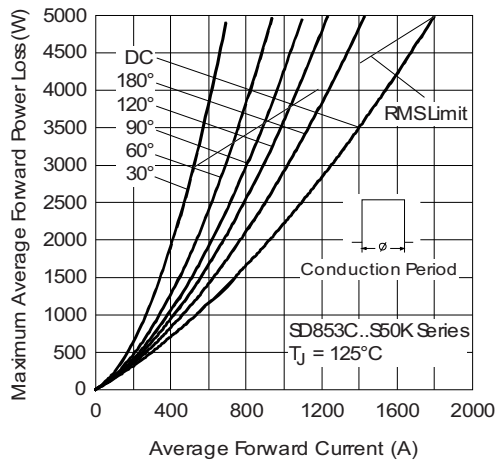

Fig. 6 - Forward Power Loss Characteristics

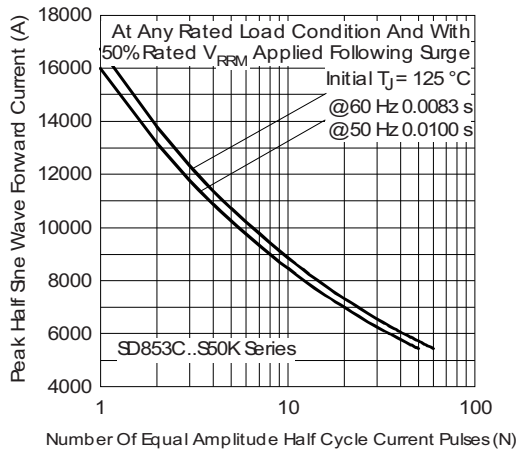

Fig. 7 - Maximum Non-Repetitive Surge Current Single and Double Side Cooled

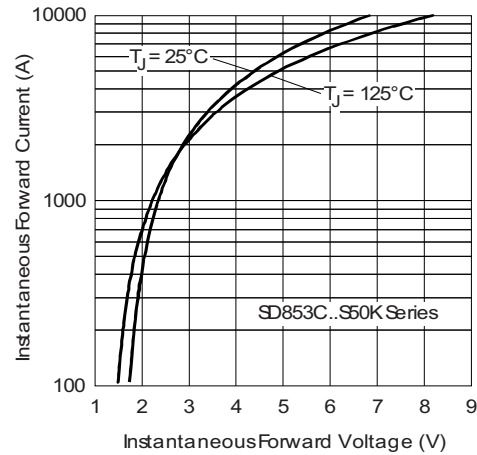

Fig. 9 - Forward Voltage Drop Characteristics

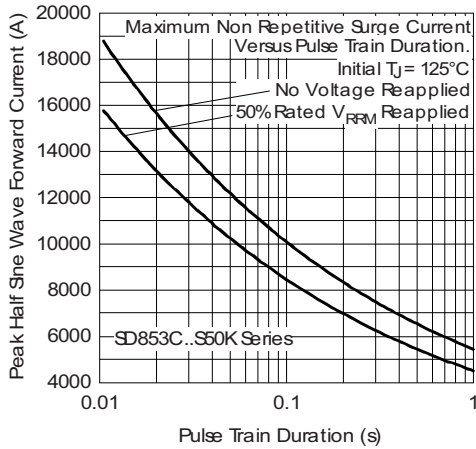

Fig. 8 - Maximum Non-Repetitive Surge Current Single and Double Side Cooled

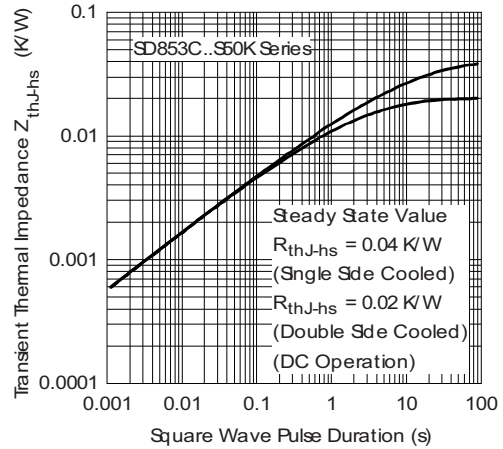

Fig. 10 - Thermal Impedance  $Z_{thJ-hs}$  Characteristics

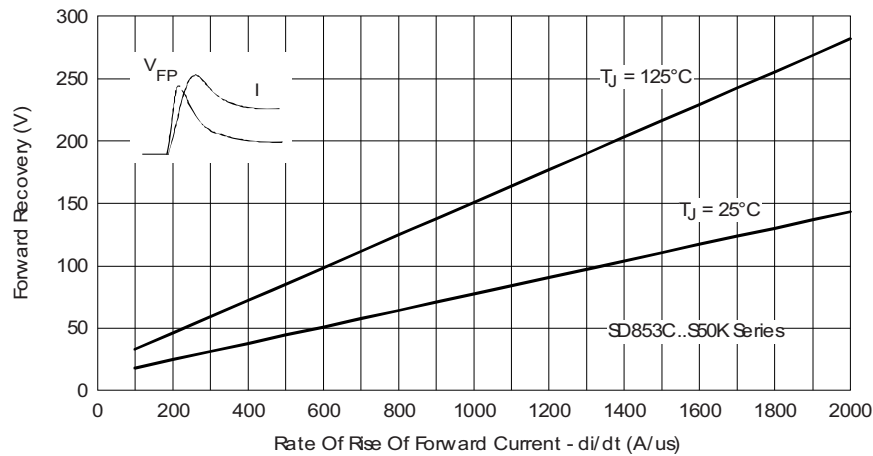

Fig. 11 - Typical Forward Recovery Characteristics

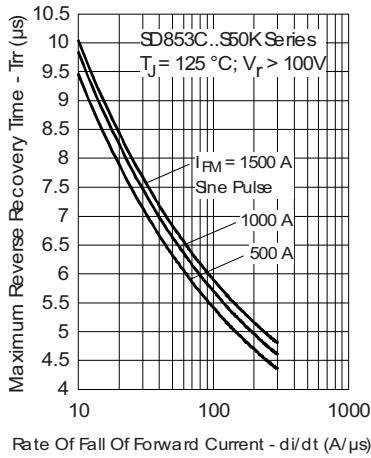

Fig. 12 - Recovery Time Characteristics

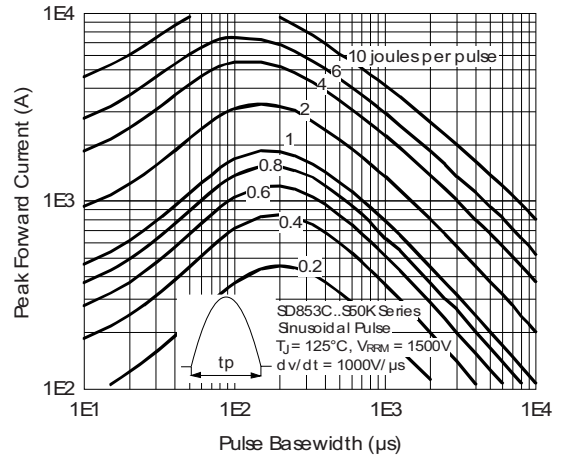

Fig. 15 - Maximum Total Energy Loss Per Pulse Characteristics

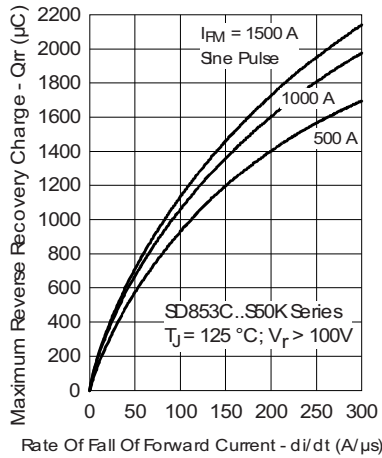

Fig. 13 - Recovery Charge Characteristics

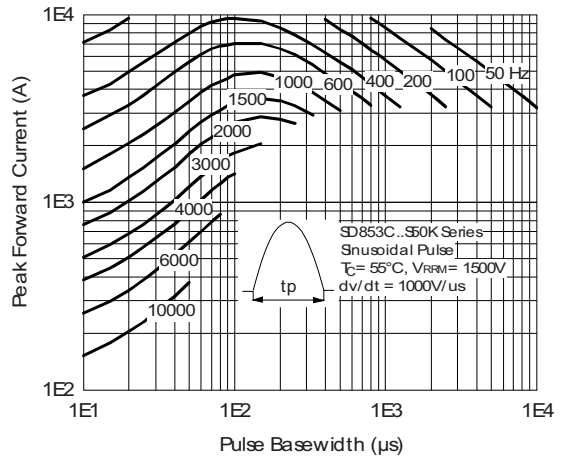

Fig. 16 - Frequency Characteristics

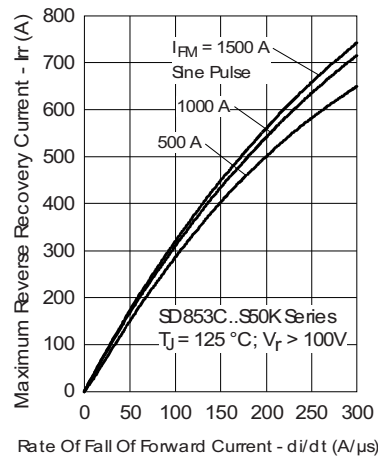

Fig. 14 - Recovery Current Characteristics

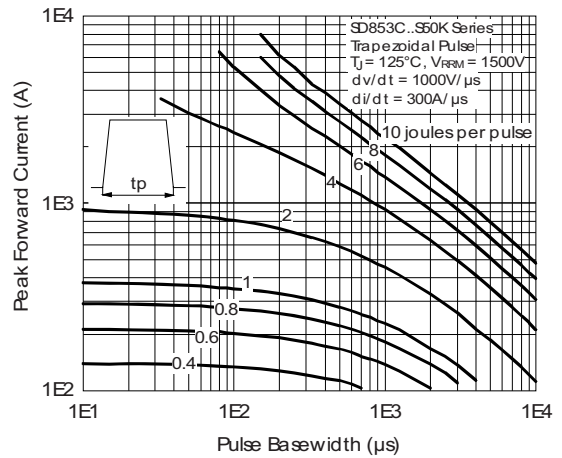

Fig. 17 - Maximum Total Energy Loss Per Pulse Characteristics

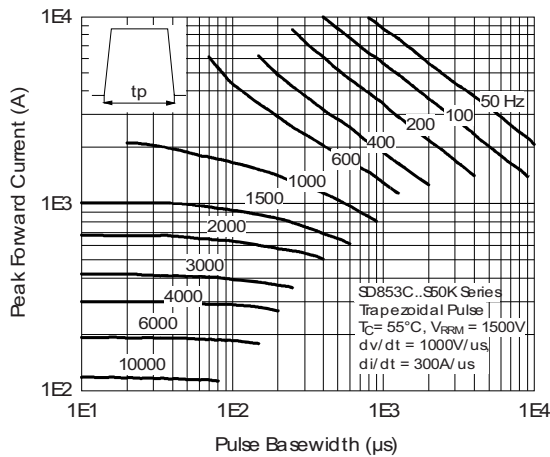

Fig. 18 - Frequency Characteristics

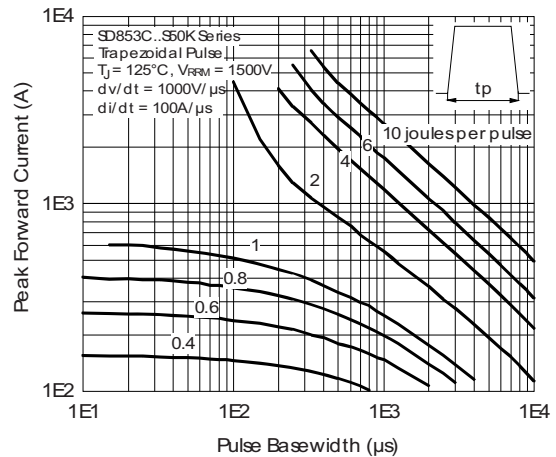

Fig. 19 - Maximum Total Energy Loss Per Pulse Characteristics

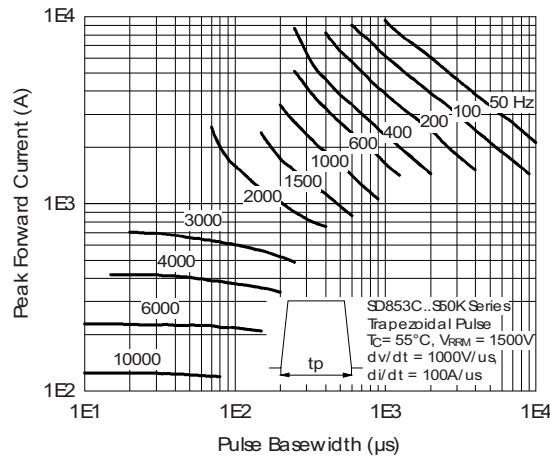

Fig. 20 - Frequency Characteristics

**ORDERING INFORMATION TABLE**

Device code	<b>VS-</b>	<b>SD</b>	<b>85</b>	<b>3</b>	<b>C</b>	<b>45</b>	<b>S50</b>	<b>K</b>
	①	②	③	④	⑤	⑥	⑦	⑧
	<b>1</b>	-	Vishay Semiconductors product	<b>2</b>	-	Diode	<b>3</b>	-
	<b>3</b>	-	Essential part number	<b>4</b>	-	3 = fast recovery	<b>5</b>	-
	<b>5</b>	-	C = ceramic PUK	<b>6</b>	-	Voltage code x 100 = V <sub>RRM</sub> (see Voltage Ratings table)	<b>7</b>	-
	<b>7</b>	-	t <sub>r</sub> code	<b>8</b>	-	K = PUK case K-PUK (DO-200AC)		

**LINKS TO RELATED DOCUMENTS**

Dimensions	<a href="http://www.vishay.com/doc?95247">www.vishay.com/doc?95247</a>
------------	--



## K-PUK (DO-200AC)

**DIMENSIONS** in millimeters (inches)

3.5 (0.14) DIA. NOM. x  
1.8 (0.07) deep MIN. both ends

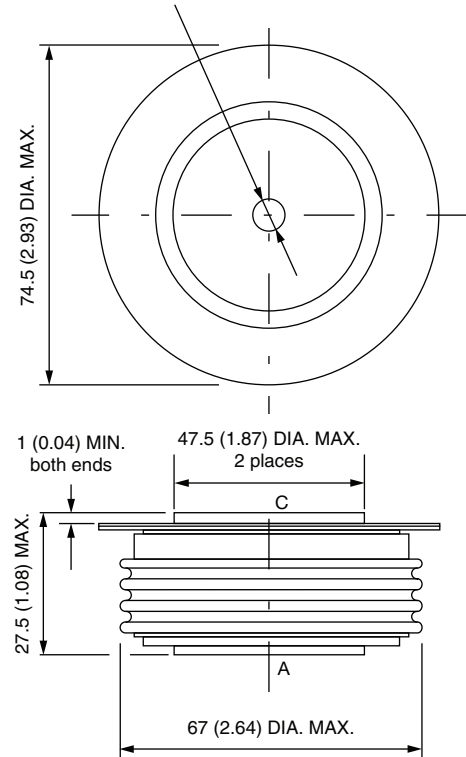

**Note:**  
A = Anode  
C = Cathode

Quote between upper and lower pole pieces has to be considered after application of mounting force (see Thermal and Mechanical Specifications)



## **Disclaimer**

ALL PRODUCT, PRODUCT SPECIFICATIONS AND DATA ARE SUBJECT TO CHANGE WITHOUT NOTICE TO IMPROVE RELIABILITY, FUNCTION OR DESIGN OR OTHERWISE.

Vishay Intertechnology, Inc., its affiliates, agents, and employees, and all persons acting on its or their behalf (collectively, "Vishay"), disclaim any and all liability for any errors, inaccuracies or incompleteness contained in any datasheet or in any other disclosure relating to any product.

Vishay makes no warranty, representation or guarantee regarding the suitability of the products for any particular purpose or the continuing production of any product. To the maximum extent permitted by applicable law, Vishay disclaims (i) any and all liability arising out of the application or use of any product, (ii) any and all liability, including without limitation special, consequential or incidental damages, and (iii) any and all implied warranties, including warranties of fitness for particular purpose, non-infringement and merchantability.

Statements regarding the suitability of products for certain types of applications are based on Vishay's knowledge of typical requirements that are often placed on Vishay products in generic applications. Such statements are not binding statements about the suitability of products for a particular application. It is the customer's responsibility to validate that a particular product with the properties described in the product specification is suitable for use in a particular application. Parameters provided in datasheets and / or specifications may vary in different applications and performance may vary over time. All operating parameters, including typical parameters, must be validated for each customer application by the customer's technical experts. Product specifications do not expand or otherwise modify Vishay's terms and conditions of purchase, including but not limited to the warranty expressed therein.

Except as expressly indicated in writing, Vishay products are not designed for use in medical, life-saving, or life-sustaining applications or for any other application in which the failure of the Vishay product could result in personal injury or death. Customers using or selling Vishay products not expressly indicated for use in such applications do so at their own risk. Please contact authorized Vishay personnel to obtain written terms and conditions regarding products designed for such applications.

No license, express or implied, by estoppel or otherwise, to any intellectual property rights is granted by this document or by any conduct of Vishay. Product names and markings noted herein may be trademarks of their respective owners.



# Mouser Electronics

Authorized Distributor

Click to View Pricing, Inventory, Delivery & Lifecycle Information:

[Vishay:](#)

[VS-SD853C45S50K](#)