

4

3

2

1

THIS DRAWING IS UNPUBLISHED.      RELEASED FOR PUBLICATION  
 © COPYRIGHT      ALL RIGHTS RESERVED.

LOC	DIST	REVISIONS					
		P	LTR	DESCRIPTION	DATE	DWN	APVD
			A2	ECR-16-002691	29FEB2016	RS	UG

THIS PART NUMBER IS OBSOLETE (NO LONGER ACTIVE OR PRODUCED).  
 THE CUSTOMER SHOULD CONTACT THEIR SALES REPRESENTATIVE OR TAC  
 TO IDENTIFY THE APPLICATOR THAT WILL PROCESS THE TERMINAL TO BE APPLIED.  
 IF ONE DOES NOT EXIST, A REQUEST TO QUOTE A NEW APPLICATOR WILL NEED TO  
 BE PROCESSED.

FOR REPLACEMENT PARTS FOR APPLICATOR 1855018  
 REFER TO ADDITIONAL PAGE(S). SPARE PARTS KIT (IF LISTED)  
 WILL REMAIN AVAILABLE.

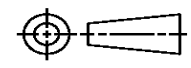
THIS DRAWING IS A CONTROLLED DOCUMENT.		DWN R.SHEN	 <b>TE Connectivity</b>	
DIMENSIONS:		CHK LJ.ZHANG		
		APVD U.GUO	NAME SIDE FEED HDM APPLICATOR	
TOLERANCES UNLESS OTHERWISE SPECIFIED:		PRODUCT SPEC	RESTRICTED TO	
0 PLC ± 1 PLC ± 2 PLC ± 3 PLC ± 4 PLC ± ANGLES ±		APPLICATION SPEC	SIZE A3	CAGE CODE
MATERIAL		WEIGHT	DRAWING NO C- 1855018	
FINISH		CUSTOMER ACCESSIBLE PRODUCTION DRAWING		SCALE
		SHEET 1 OF 2		REV A2

PART NUMBER	REV	FIRST USED	POWER UNIT	FEED TYPE	DESCRIPTION
1855018-1	A	122500-1	LEADMAKER	POST FEED	CUTS CARRIER
1855018-2	A	565435-5	BENCH MODEL K	PRE FEED	CUTS CARRIER
1855018-3	A	354500-1	BENCH MODEL G	PRE FEED	CUTS CARRIER
1855018-6	A	122500-1	LEADMAKER	POST FEED	CONTINUOUS CARRIER
7-1855018-7	A	-	-	-	SPARE PARTS

- △ RECOMMENDED SPARE PARTS
- △ GREASE LIGHTLY
- △ GUARD MUST BE IN PLACE WHEN OPERATING APPLICATOR IN A BENCH MACHINE
- △ GRIND AT ASSEMBLY.
- △ FEED ADJUSTMENT MAY BE REQUIRED.

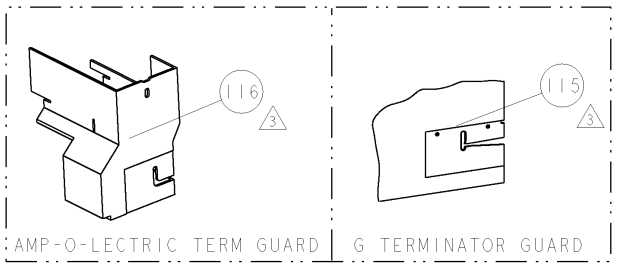

TERMINAL NAME: MALE METRI-PACK 280					
TYCO PN	MFG PN	PACKARD TERMINAL - AMP CRIMP SPECS			
286618	12034047				
△ 286804	12020119	REF SETTING	CRIMP HEIGHT	WIRE SIZE	
-	-	D2	1.25±0.05mm [.049±.002]	0.8mm2	
-	-	D6	1.20±0.05mm [.047±.002]	0.5mm2	
-	-	-	-	-	
-	-	-	-	-	
-	-	CRIMP	SIZE	TYPE	RANGE
-	-	WIRE	.094 [2.39mm]	F	0.5-0.8mm2
-	-	INSUL	.135 [3.43mm]	F	∅.079-.106
WIRE STRIP LENGTH	TERM APPL SPEC	FEED	APPL INSTRUCTIONS	SET UP GAGE	
.187 -.202	NONE	.488	408-8040	458637-1	

LOC	SIST	REV	DESCRIPTION	DATE	OWN	APPD
A	66	1	RELEASED	23FEB2006	ROW	TE
		1	ECR-06-008661	10APR2006	MY	TE

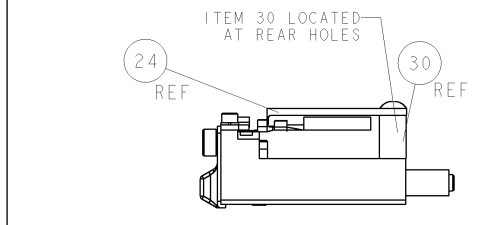
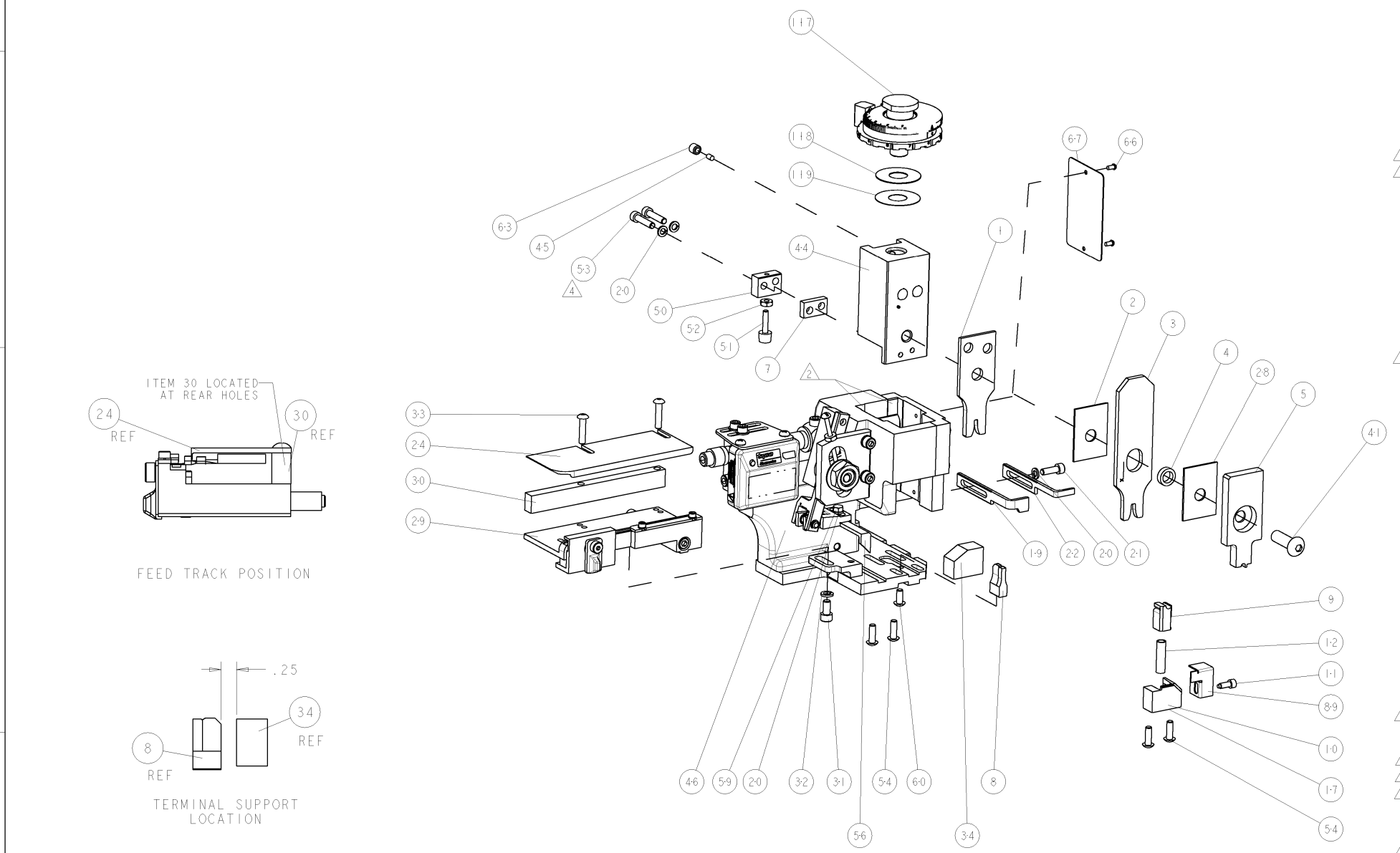

FEED TRACK POSITION

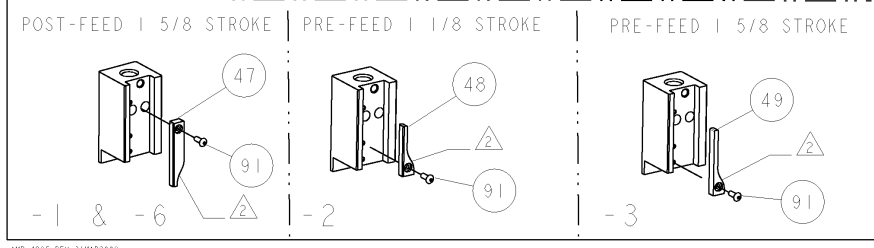
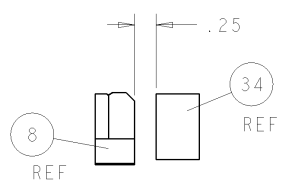

-	1	1	1	1	-	690125-1	SHIM SUB-ASSY	119
-	1	1	1	1	-	469367-9	SHIM	118
-	1	1	1	1	-	879103-3	FINE ADJUST HEAD SUBASSY	117
-	-	-	REF	-	..	455749-1	GUARD WINDOW	116
-	-	-	REF	-	..	679532-1	INSERT, GUARD	115
-	1	1	1	1	-	1-21002-7	SCR, BTN SKT HD CAP 6-32 X .375	91
-	1	1	1	1	-	318563-1	GUARD, FRONT CHIP	89
-	1	1	1	1	-	4088040	SF APPL INST 408-8040	72
-	1	1	1	1	-	217238-1	GENERAL INSTRUCTION PKG	71
-	1	1	1	1	-	461264-5	PLATE, IDENTIFICATION	67
-	2	2	2	2	-	21017-2	SCREW, DRIVE	66
-	1	1	1	1	-	21009-2	SCR, SET, SELF LOCKING 1/4-20 X .250	63
-	1	1	1	1	-	22733-8	SCR, BHSC, SELF-LOCKING, 8-32 X .375	60
-	1	1	1	1	-	2-22603-0	SCR, HEX HD CAP 8-32 X .312	59
-	1	1	1	1	-	458537-2	PAWL, FEED	56
-	4	4	4	4	-	2-21002-2	SCR, BTN SKT HD CAP 8-32 X .500	54
-	2	2	2	2	-	2-21000-9	SCR, SKT HD CAP 8-32 X .750	53
-	1	1	1	1	-	21018-5	NUT, HEX, REG 6-32	52
-	1	1	1	1	-	811242-2	BUMPER, HOLD DOWN	51
-	1	1	1	1	-	690753-1	SPACER, TONKER	50
-	-	-	-	-	..	690602-6	CAM, PRE FEED, 1/8	49
-	-	-	-	-	..	690602-5	CAM, PRE FEED, 1/8	48
-	1	-	-	-	-	690501-4	CAM, POST FEED, 1/8	47
-	1	1	1	1	-	459456-1	APPL. BASIC SUB ASSY (SIDE WISE MOCA)	46
-	1	1	1	1	-	690191-1	PLUG, NYLON	45
-	1	1	1	1	-	455673-1	RAM, SIDE FEED	44
-	1	1	1	1	-	7-21002-9	SCR, BTN SKT HD CAP 5/16-24 X 1.00	41
-	1	1	1	1	-	690786-3	TERMINAL SUPPORT	34
-	2	2	2	2	-	2-21002-4	SCR, BTN SKT HD CAP 8-32 X .750	33
-	1	1	1	1	-	21024-5	WASHER, SPRG LOCK, REG NO 10	32
-	1	1	1	1	-	3-21000-4	SCR, SKT HD CAP 10-32 X .375	31
-	1	1	1	1	-	1320908-1	SPACER, STRIP GUIDE	30
-	1	1	1	1	-	1633091-7	ASSEMBLY, STRIP GUIDE	29
-	1	1	1	1	-	1-455888-0	SPACER, CRIMPER	28
-	1	1	1	1	-	1320928-3	PLATE, STRIP GUIDE	24
-	1	-	-	-	-	690472-2	STRIPPER	22
-	1	1	1	1	-	2-21000-7	SCR, SKT HD CAP 8-32 X .500	21
-	4	4	4	4	-	21024-4	WASHER, SPRG LOCK, REG NO 8	20
-	-	-	-	-	-	691353-1	STRIPPER	19
-	1	-	-	-	-	679625-1	SHEAR HOLDER, FRONT (NO CUT)	17
-	1	1	1	1	-	3-22280-3	SPRING, COMPRESSION	12
-	1	1	1	1	-	690461-1	STOP, SHEAR	11
-	-	-	-	-	-	690459-1	SHEAR HOLDER, FRONT	10
-	1	1	1	1	-	462006-7	FLOATING SHEAR, FRONT	9
1	1	1	1	1	-	5-1633116-0	ANVIL, COMBINATION	8
-	1	1	1	1	-	1-240641-0	SPACER	7
-	1	1	1	1	-	2-455889-0	DEPRESSOR, SHEAR	5
-	1	1	1	1	-	3-238011-1	BLOCK, CRIMPER SPACER	4
1	1	1	1	1	-	7-683453-6	CRIMPER, INSULATION PREMIUM	3
-	1	1	1	1	-	455888-9	SPACER, CRIMPER	2
1	1	1	1	1	-	1-1752057-9	CRIMPER, WIRE PREMIUM, STEPPED	1

DIMENSIONS: INCHES		TOLERANCES UNLESS OTHERWISE SPECIFIED:		DRAWN: R. O. WILSON 09FEB2006		CHECKED: R. O. WILSON 09FEB2006		APPROVED: T. ELRIN 09FEB2006		NAME: SID FEED HDM APPLICATOR	
0.001		0.001		0.001		0.001		0.001		SIZE: A1	
0.001		0.001		0.001		0.001		0.001		CASE CODE: 00779	
0.001		0.001		0.001		0.001		0.001		DRAWING NO: 1855018	
0.001		0.001		0.001		0.001		0.001		RESTRICTED TO: -	
0.001		0.001		0.001		0.001		0.001		SCALE: 3:5	
0.001		0.001		0.001		0.001		0.001		SHEET 1 OF 1	
0.001		0.001		0.001		0.001		0.001		REV A1	

# Mouser Electronics

Authorized Distributor

Click to View Pricing, Inventory, Delivery & Lifecycle Information:

[TE Connectivity:](#)

[1855018-3](#)