

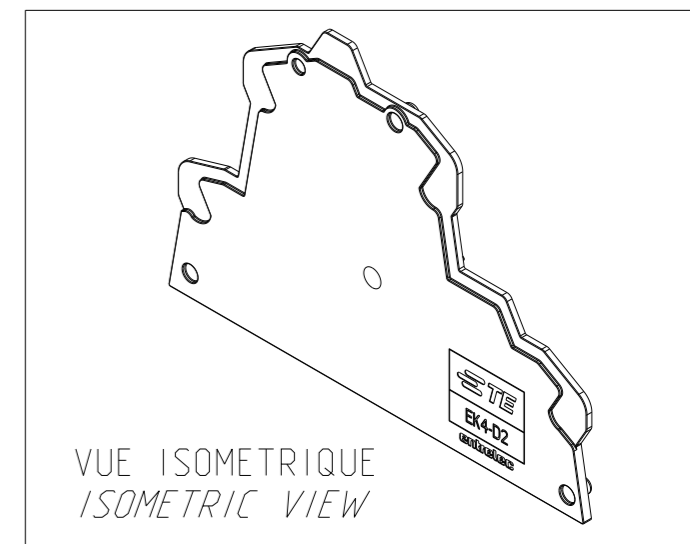

| P | LTR | DESCRIPTION | DATE | DWN | APVD |
|---|-----|----------------|-----------|-----|------|
| | 1 | First Released | 18FEB2022 | CD | |
| | | | | | |
| | | | | | |

ECHELLE 3:2
SCALE 3:2

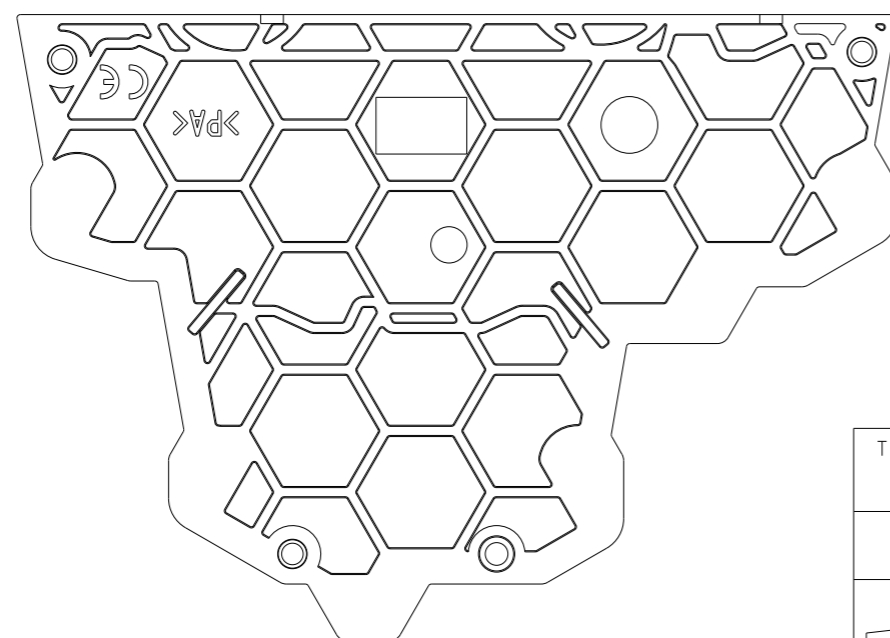
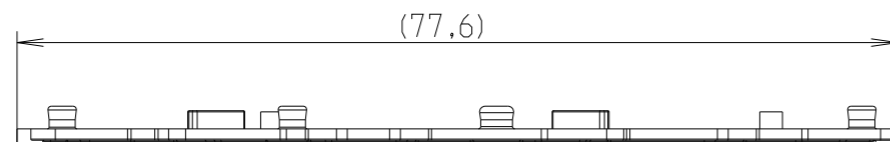
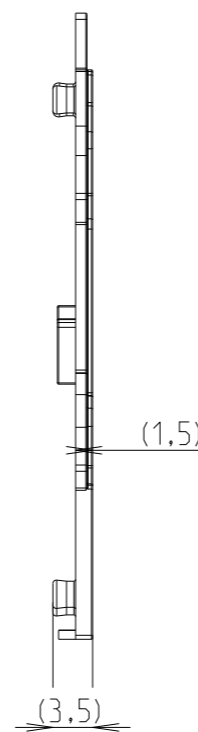
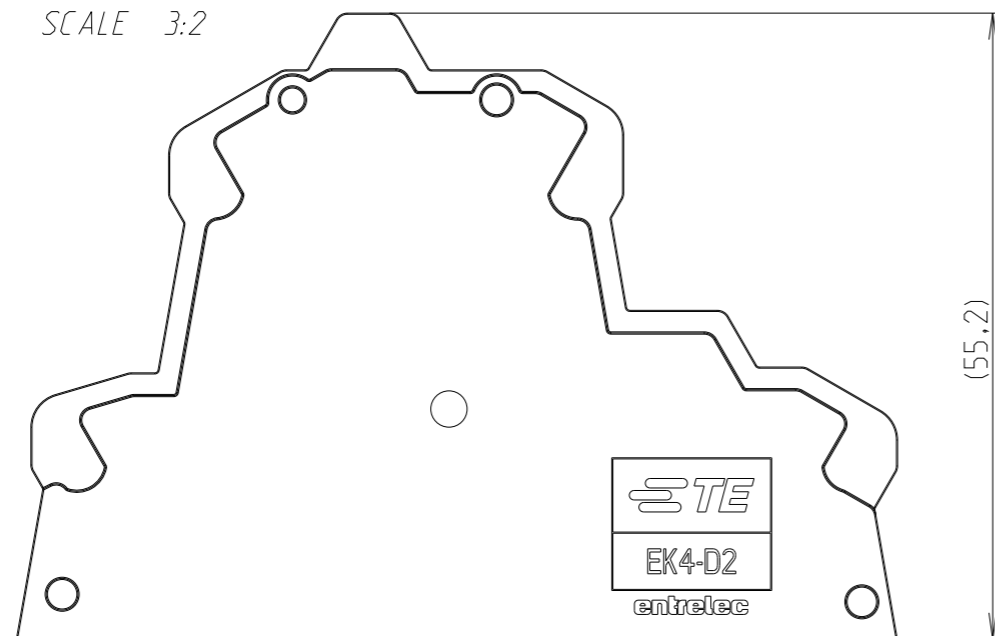

| | | | | | |
|---|--|--|---------|---|-------------------------------|
| THIS DRAWING IS A CONTROLLED DOCUMENT. | | DWN - Jan-23 10:36:51 AM Deligny, Charlotte | |  TE Connectivity | |
| DIMENSIONS: mm | | TOLERANCES UNLESS OTHERWISE SPECIFIED: | | | |
|  | | 0 PLC | ± | APVD | NAME EK4-D2 |
| | | 1 PLC | ±0.1 | PRODUCT SPEC | 1SNK706960R0000 |
| MATERIAL 1SBA581601P712X | | 2 PLC | ±0.01 | APPLICATION SPEC | SIZE A3 |
| | | 3 PLC | ±0.005 | WEIGHT | CAGE CODE 00779 |
| FINISH finish_spec_2 | | 4 PLC | ±0.0001 | CUSTOMER DRAWING; RESTRICTED CUSTOMER | DRAWING NO 1SNP201532-0100 |
| | | ANGLES | ± | SCALE | 1:1 |
| | | | | SHEET | 1 OF 1 |
| | | | | REV | 3 |

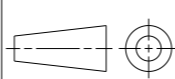
Mouser Electronics

Authorized Distributor

Click to View Pricing, Inventory, Delivery & Lifecycle Information:

[TE Connectivity:](#)

[1SNK706960R0000](#)