

MicroSpeed POWER MODULES & POWER CONNECTORS



MicroSpeed POWER MODULES- HIGH-POWER. INTERCONNECT. SOLUTIONS.

This complementary range of Power Module connectors, with 2.0 mm contact pitch, fulfils the need for miniaturized and high reliability power systems, and offers a large number of options for mezzanine applications. One of its features is its high current-carrying capacity in comparison to its small size. Therefore, the system is excellently suited for use with small, high performance devices such as CPUs, drives, LCD panels, etc.

Providing a variety of height versions of the male and female connectors, the Power Module series enables stacking heights from 5 mm to 20 mm. Subsequently, almost every need for different Printed Circuit Board (PCB) arrangements can be addressed. Another major advantage is the multiple-connector mating capability, which allows the mating of more than one connector pair at the same time.

The Surface Mount Technology (SMT) connectors meet all the needs of fast automatic assembly machines. They are manufactured and 100% inline quality checked by machine to provide high coplanarity and optimized soldering. The layout is designed with an enhanced solder pad size to provide high retention forces. The integrated 3-point double beam female contact provides durable low-contact resistance over the whole lifecycle.

The contacts are post plated, leaving no bare edges in the contact and solder areas. The connectors are equipped with polarized positioning pegs, and the connector plating is lead free, complying with the European RoHS directive.

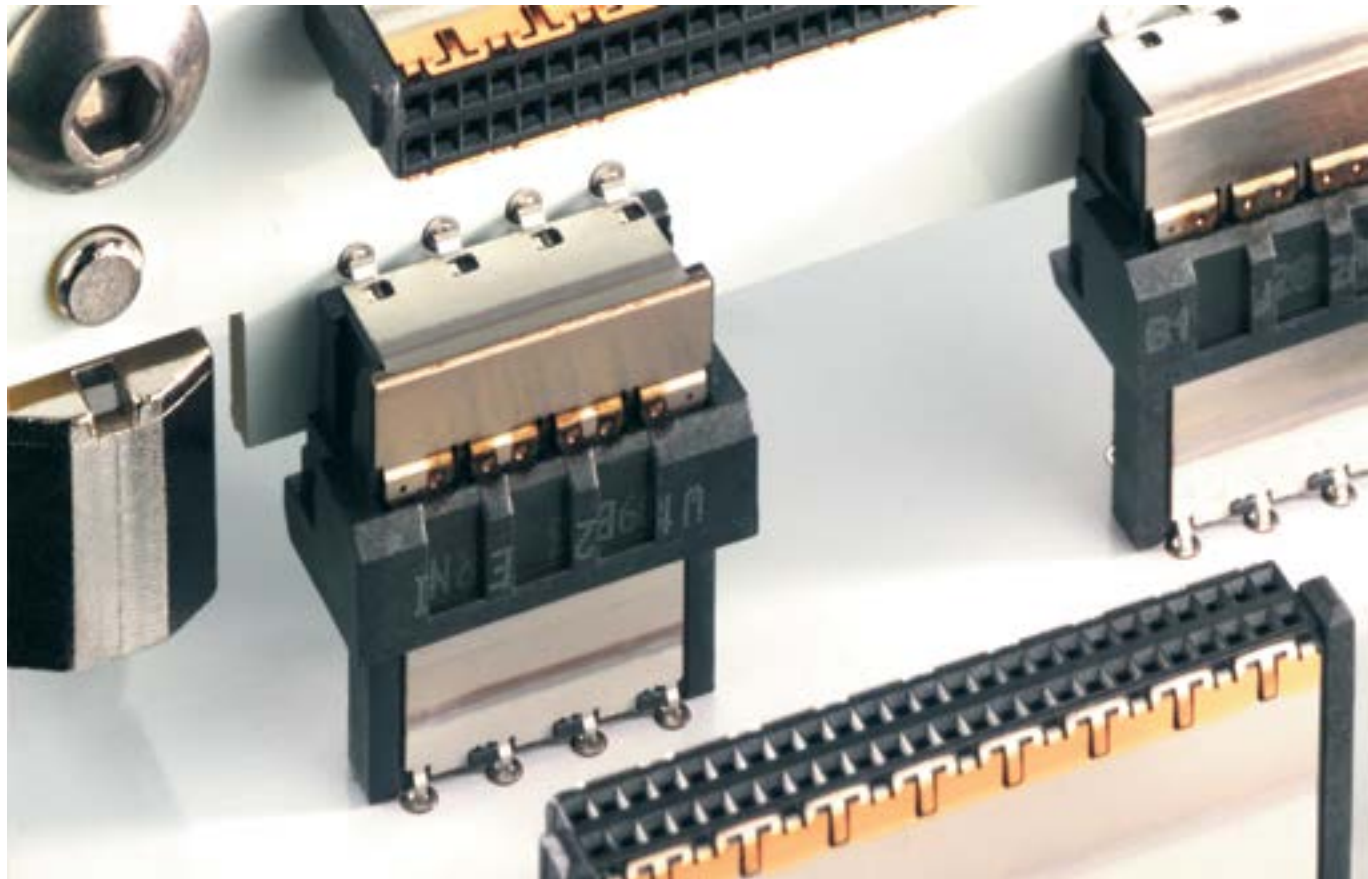

FEATURES

No. of Pins	5
Current rating per contact	up to 18 A
Temperature range	-55 °C to 125 °C
Board-to-Board heights	5 - 20 mm
Termination technology	SMT, SMT/ Through Hole Reflow (THR) and THR
Applications	orthogonal
	mezzanine
	coplanar
Variants	male and female connectors
	vertical and right angle
	Non-Blind Mate and Blind Mate shielded



CAPABILITIES

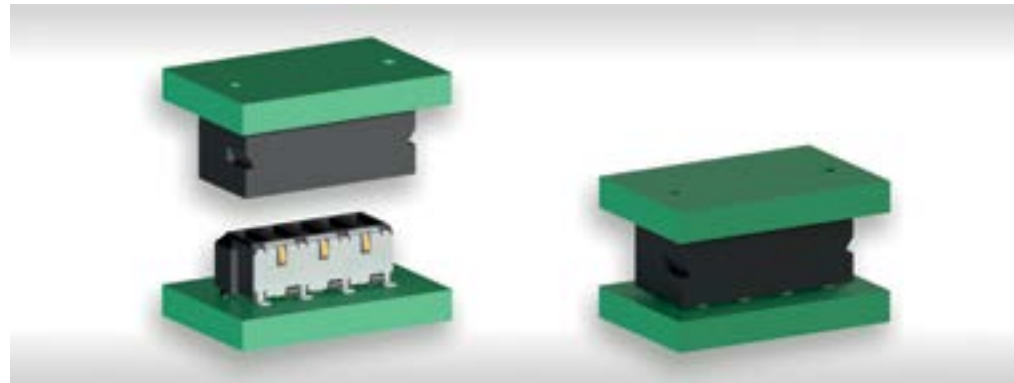

- stacked boards (mezzanine)

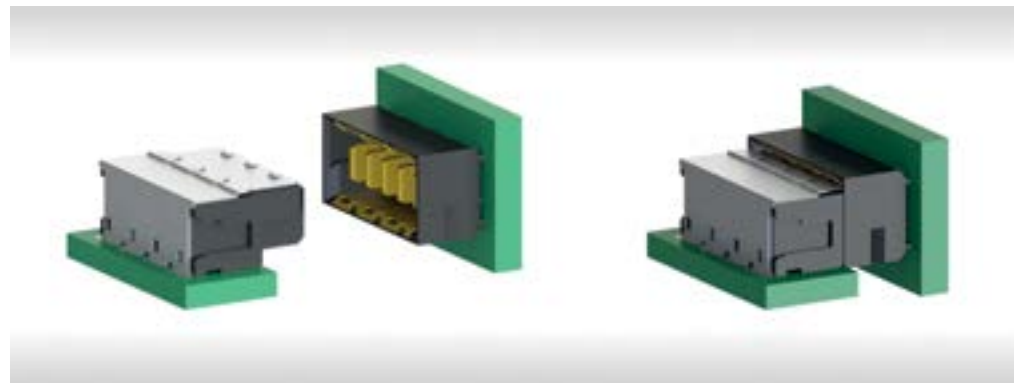

- orthogonal boards

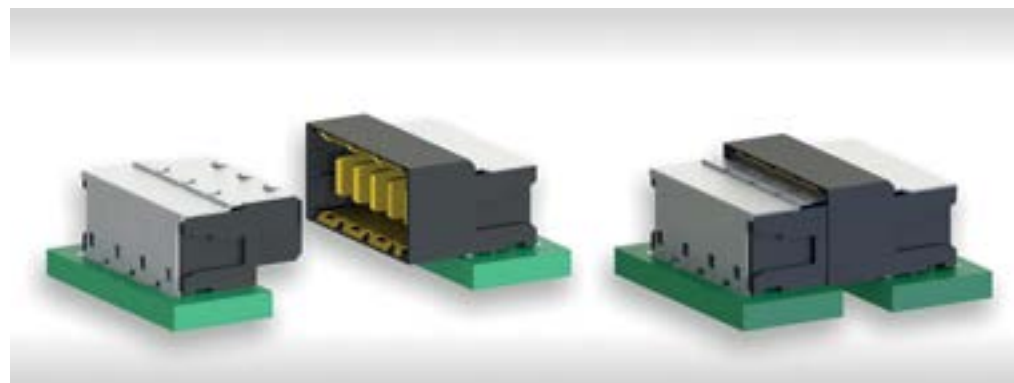

- extender card (coplanar)

ADVANTAGES

Blind Mate Design

- Blind Mate versions feature
 - a distinctive polarization of the mating face
 - extended guides to capture the mating connector
 - increased wall thickness
 - slightly larger footprint
- self-aligning feature, guide the Blind Mate connectors into correct mating position
- designed to provide consistent and reliable mating even in difficult conditions
- robust connectors for harsh environments
- shrouded housing protect contacts; high-temperature resistant materials
- distinctive polarization significantly reduces mismatching



Contact Design

- superior reliability due to dual-beam female contact design:
 - 3-point dual-beam female contact
 - homogeneous, rolled surface provides for more secure contact
 - wide contact surface between mated pair
 - low surface roughness minimizes abrasion
 - low contact resistance
- provides excellent misalignment tolerance/ tolerance compensation
- wipe length 1,5 mm
- durability: > 500 mating cycles
- contact finish: Au plating



Pick & Place Pad

- pick and place pad for vacuum pick-up nozzles provided for straight connectors
- high-temperature plastic to resist reflow solder temperatures
- right angled versions are commonly picked-up at the smooth shield surface



Termination

- SMT: SMT high power blade contacts, SMT shield terminals
 - double sided board assembly
 - 100% machine tested by TE coplanarity of ≤ 0.1 mm leads to excellent soldering results
- SMT/THR: SMT high power blade contacts, THR shield terminals
 - THR shield terminals provide strong mechanical solder joint for demanding applications
- THR: THR high power blade contacts, THR shield terminals
 - THR shield terminals provide strong mechanical solder joint for demanding applications



PROCESSING

Tape and Reel Packaging

- transport safe packaging
- automatic assembly

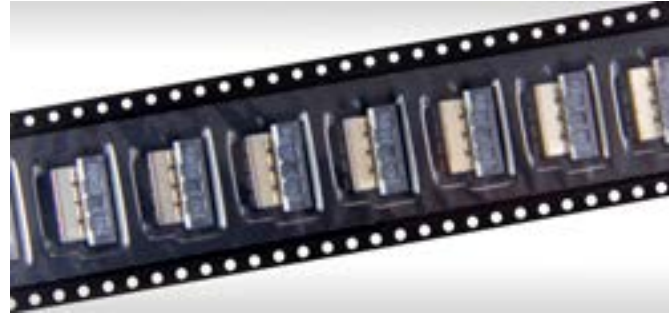

Automatic Assembly and Reflow Soldering

- for efficient processing on modern assembly lines



WIPE LENGTH AND TOLERANCES

Wipe Length

- 1.5 mm
- Blind Mate version

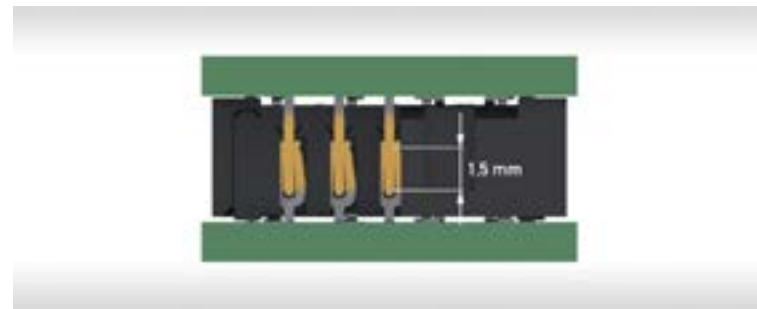

Allowed Inclination for Secure Self-Centering

- angular inclination longitudinal 4° (1° in combination with misalignment)
- angular inclination transverse 2°
- Blind Mate version

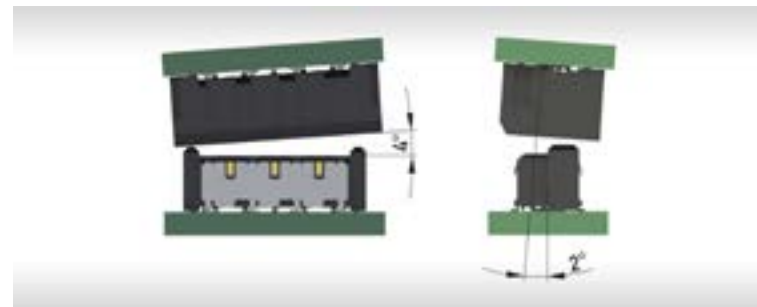

Allowed Misalignment for Secure Self-Centering

- misalignment tolerance of 0,7 mm
- Blind Mate version

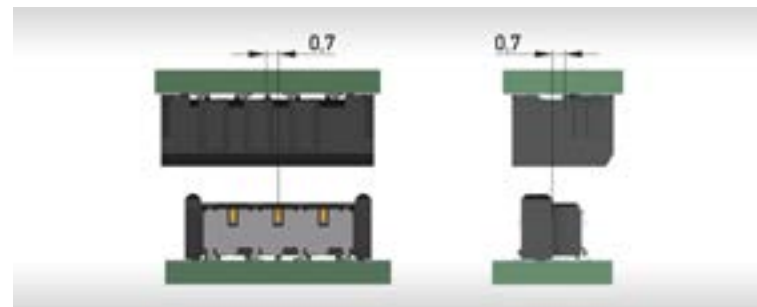

BOARD-TO-BOARD HEIGHT

Flexible Board Stacking

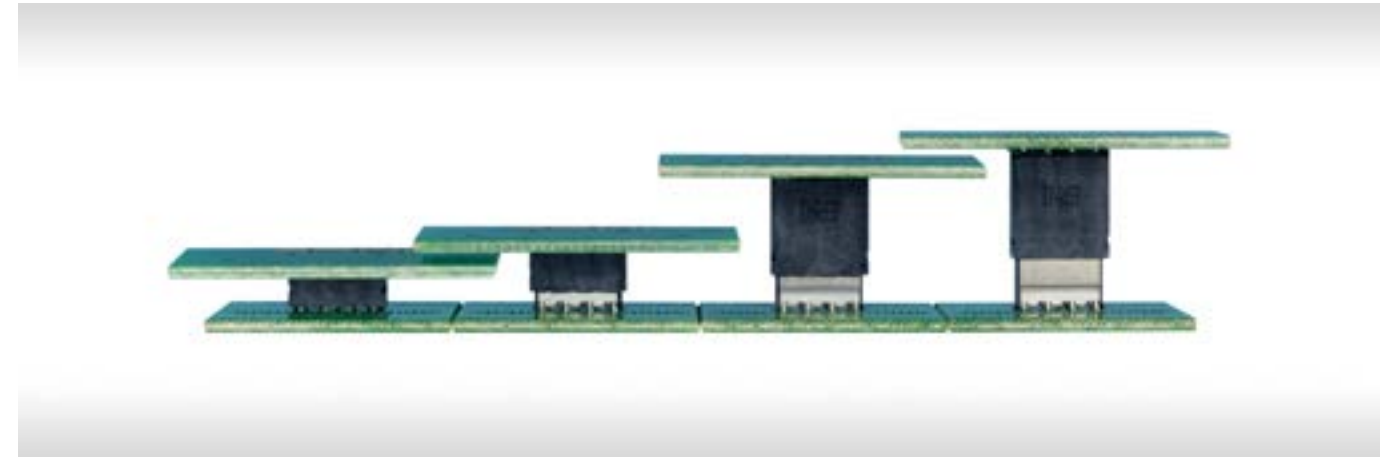

Board-to-Board Height	Male Stacking Height	Female Stacking Height
5 - 6 mm	1 mm	4 mm
6 - 7 mm	2 mm	4 mm
7 - 8 mm	1 mm	6 mm
8 - 9 mm	2 mm	6 mm
9 - 10 mm	1 mm	8 mm
10 - 11 mm	2 mm	8 mm
11 - 12 mm	1 mm	10 mm
12 - 13 mm	2 mm	10 mm
13 - 14 mm	9 mm	4 mm
14 - 15 mm	10 mm	4 mm
15 - 16 mm	9 mm	6 mm
16 - 17 mm	10 mm	6 mm
17 - 18 mm	9 mm	8 mm
18 - 19 mm	10 mm	8 mm
19 - 20 mm	9 mm	10 mm
20 - 21 mm	10 mm	10 mm

ELECTRICAL AND MECHANICAL CHARACTERISTICS

Technical Data

Description	Standard	MicroSpeed Power Modules
Climate category	DIN EN 60068-1 test b	55 / 125 / 56
Temperature range		-55 / 125 °C
Current rating per contact	IEC60512 test 5b	up to 18 A / 10 A per shield
Air- and creepage (min.)		contact - contact 1.5 mm contact - ground 0.9 mm
Operating voltage	IEC 60664	The permissible operating voltages depends on the customer application and on the applicable or specified safety requirements. Insulation coordination according to IEC 60664-1 has to be regarded for the complete electrical device. Therefore, the maximum creep- age and clearance distances of the mated connectors are specified for consideration as a part of the whole current path. In practice, reductions in creepage or clearance distances may occur due to the conductive pattern of the printed board or the wiring used, and have to be taken into account separately. As a result the creepage and clearance distances for the application may be reduced compared to those of the connector.
Dielectric strength	IEC 60512 test 4a	contact - contact 500 V _{rms} contact - ground 500 V _{rms}
Contact resistant	IEC 60512 test 2a	< 4 mΩ
Insulation resistant	IEC 60512 test 3a	> 10 ⁴ MΩ
Vibration, sine	IEC 60512 test 6d	10 - 2000 Hz 20 g
Contact disturbance (while vibration test)	IEC 60512 test 2e	< 1 μs
Shock, halvesine	IEC 60512 test 6c	50 g 11 ms
Contact disturbance (while shock test)	IEC 60512 test 2e	< 1 μs
Mechanical operation	IEC 60512 test 9a	500 mating cycles
Insertion and withdrawal force	IEC 60512 test 13b	< 5 N
Gauge retention force	IEC 60512 test 16e	> 0.5 N
Processing Conditions		
Reflow soldering temperature max.	JEDEC J-STD-020	10 s at 260 °C
Coplanarity		< 0.1 mm

ELECTRICAL AND MECHANICAL CHARACTERISTICS

Technical Data

Description	Standard	MicroSpeed Power Modules
Housing Material		
Insulation body		LCP
CTI value	IEC 112	175
UL flame rating	UL 94	V-0
UL file plastic material		E83005
MSL	JEDEC J-STD-020	Level 1
Contact Material		
Base material		Cu alloy
Mating area		Gold plating
Termination area		Sn
Environment Compatibility		
Recycling		no flame-retardant additives, no toxic additives allow easy recycling
Product Approval		
UL/CSA		E84703

RIGHT ANGLE FEMALE

Product Specification

- MicroSpeed Power Module
- 5 pin
- current rating up to 18 A per contact
- SMT or THR termination
- tape and reel packaging
- for available part numbers please refer to our website



Dimensional Drawings

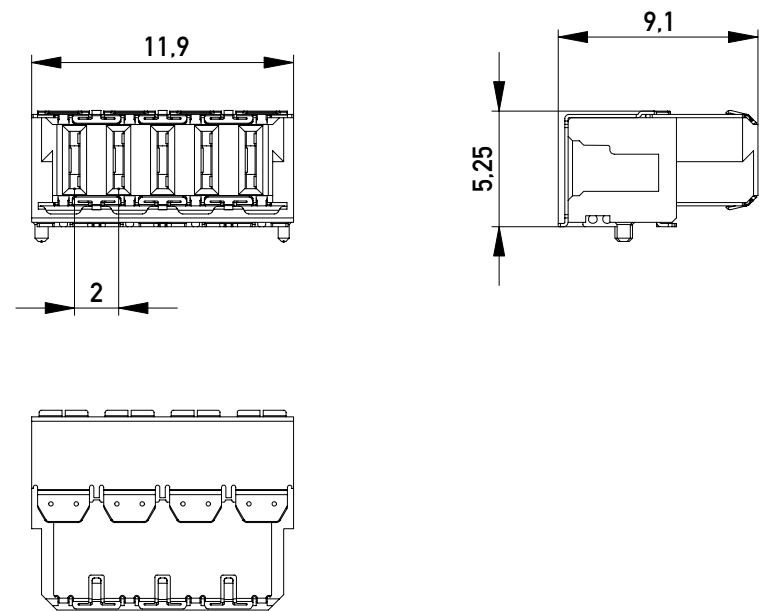

Recommended Layout

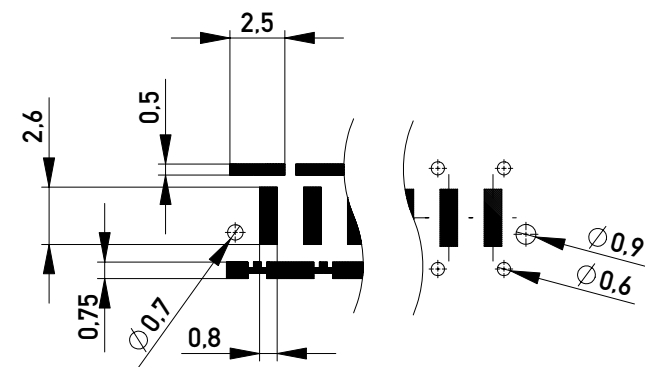

All dimensions in mm

BLIND MATE, RIGHT ANGLE FEMALE

Product Specification

- MicroSpeed Power Module
- 5 pin
- current rating up to 18 A per contact
- SMT or THR termination
- for robust applications (reinforced side walls)
- tape and reel packaging
- for available part numbers please refer to our website



Dimensional Drawings

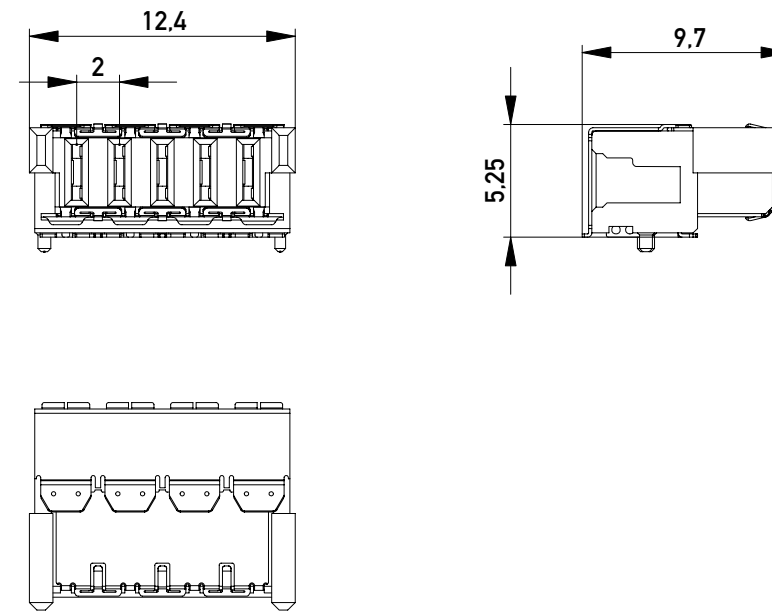

Recommended Layout

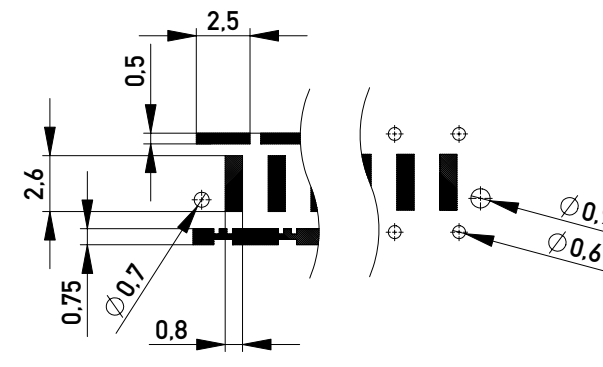

All dimensions in mm

VERTICAL FEMALE

Product Specification

- MicroSpeed Power Module
- 5 pin
- current rating up to 18 A per contact
- SMT or THR termination
- tape and reel packaging
- heights: 4, 6, 8, 10 mm
- for available part numbers please refer to our website



Dimensional Drawings

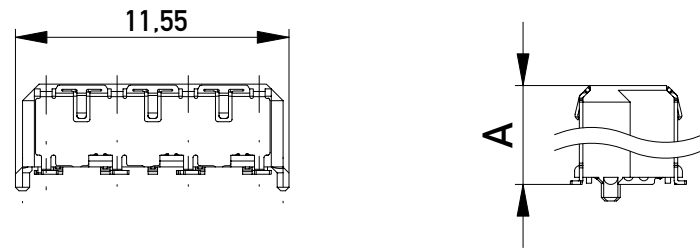

Stacking Height	A
4 mm	3.80
6 mm	5.80
8 mm	7.80
10 mm	9.80

All dimensions in mm

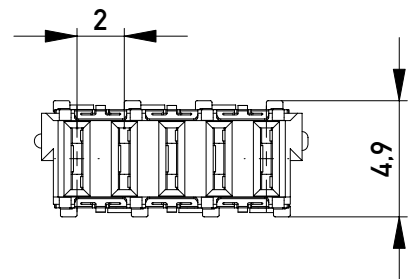

Recommended Layout

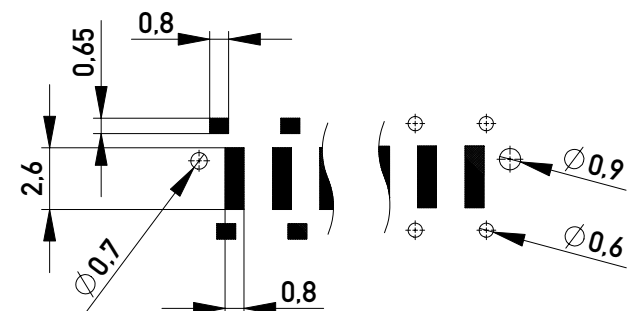

All dimensions in mm

BLIND MATE, VERTICAL FEMALE

Product Specification

- MicroSpeed Power Module
- 5 pin
- current rating up to 18 A per contact
- SMT or THR termination
- for robust applications (reinforced side walls)
- tape and reel packaging
- heights: 4, 6, 8, 10 mm
- for available part numbers please refer to our website



Dimensional Drawings

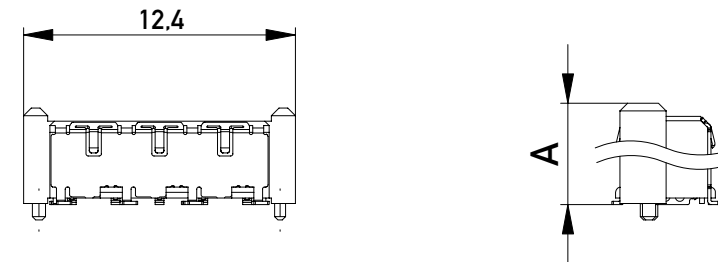

Stacking Height	A
4 mm	3.80
6 mm	5.80
8 mm	7.80
10 mm	9.80

All dimensions in mm

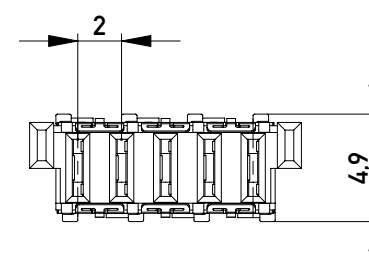

Recommended Layout

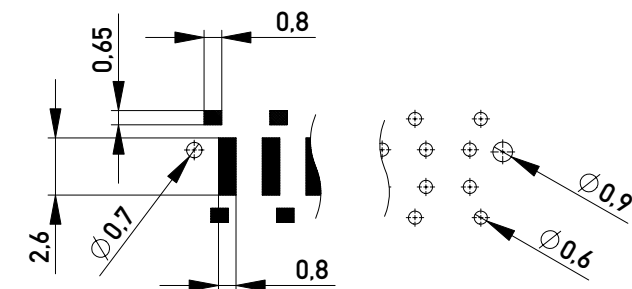

All dimensions in mm

RIGHT ANGLE MALE

Product Specification

- MicroSpeed Power Module
- 5 pin
- current rating up to 18 A per contact
- SMT or THR termination
- tape and reel packaging
- for available part numbers please refer to our website



Dimensional Drawings

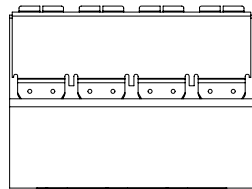
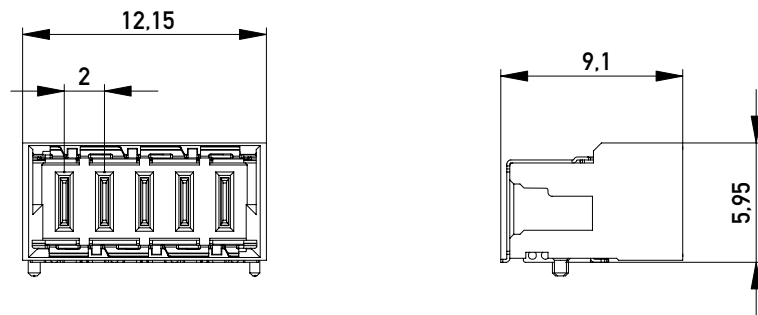

Recommended Layout

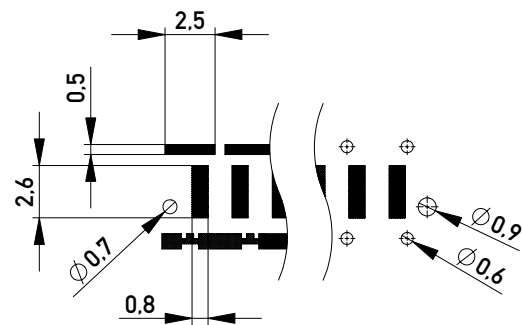

All dimensions in mm

BLIND MATE, RIGHT ANGLE MALE

Product Specification

- MicroSpeed Power Module
- 5 pin
- current rating up to 18 A per contact
- SMT or THR termination
- for robust applications (reinforced side walls)
- tape and reel packaging
- for available part numbers please refer to our website



Dimensional Drawings

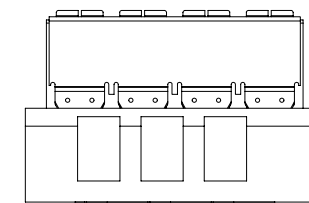
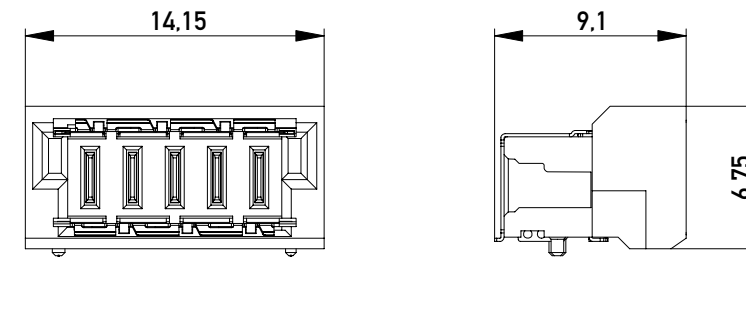

Recommended Layout

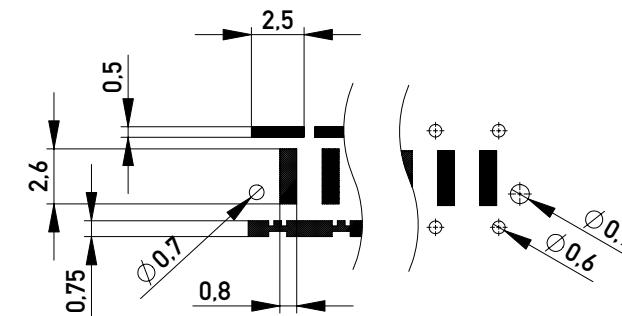

All dimensions in mm

VERTICAL MALE

Product Specification

- MicroSpeed Power Module
- 5 pin
- current rating up to 18 A per contact
- SMT or THR termination
- tape and reel packaging
- heights: 1, 2, 9, 10 mm
- for available part numbers please refer to our website

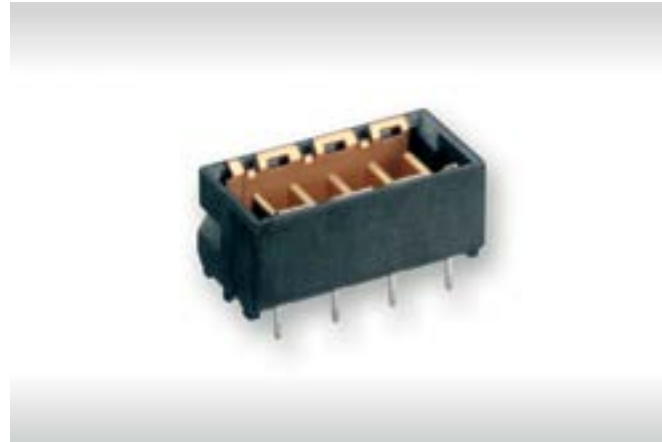

Dimensional Drawings

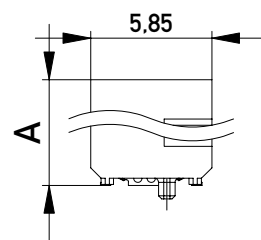
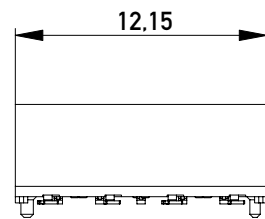

Stacking Height	A
1 mm	6.30
2 mm	7.30
9 mm	14.30
10 mm	15.30

All dimensions in mm

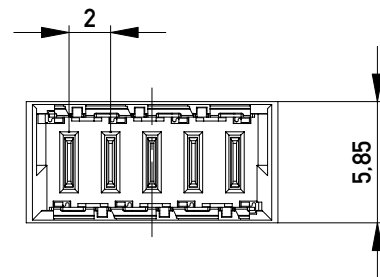

Recommended Layout

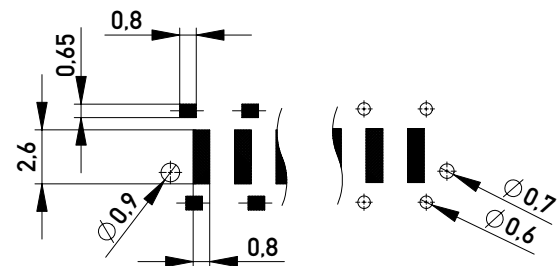

All dimensions in mm

BLIND MATE, VERTICAL MALE

Product Specification

- MicroSpeed Power Module
- 5 pin
- current rating up to 18 A per contact
- SMT or THR termination
- for robust applications (reinforced side walls)
- tape and reel packaging
- heights: 1, 2, 9, 10 mm
- for available part numbers please refer to our website



Dimensional Drawings

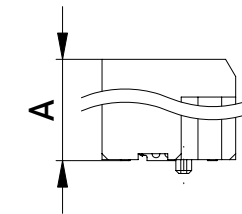
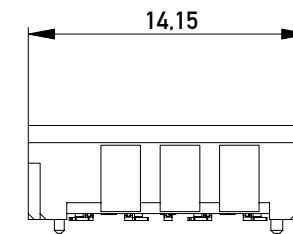

Stacking Height	A
1 mm	6.30
2 mm	7.30
9 mm	14.30
10 mm	15.30

All dimensions in mm

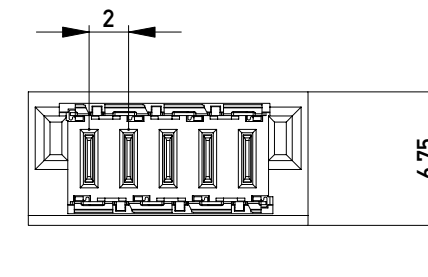

Recommended Layout

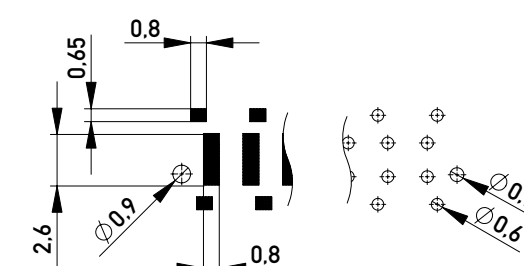

All dimensions in mm

POWER CONNECTORS

Power Connectors and MicroSpeed Power Modules share the common characteristic of having a high current carrying capacity compared to their small size. Therefore, both systems are excellently suited for use with small, high-performance devices. With the integrated 3-point double beam female contact they provide durable low-contact resistance over the whole lifecycle.

The power connectors as well as the SMT version of microspeed power modules meet the needs of fast automatic assembly machines. They are delivered with a pre-assembled pick&place pad.

Power connectors and MicroSpeed power modules differ based on the pins. This unshielded connector can supply up to 32 pins and is available as 1 or 2-row version. Higher operating voltages are possible due to a variable distance between the contacts. This provides high flexibility in the applications.

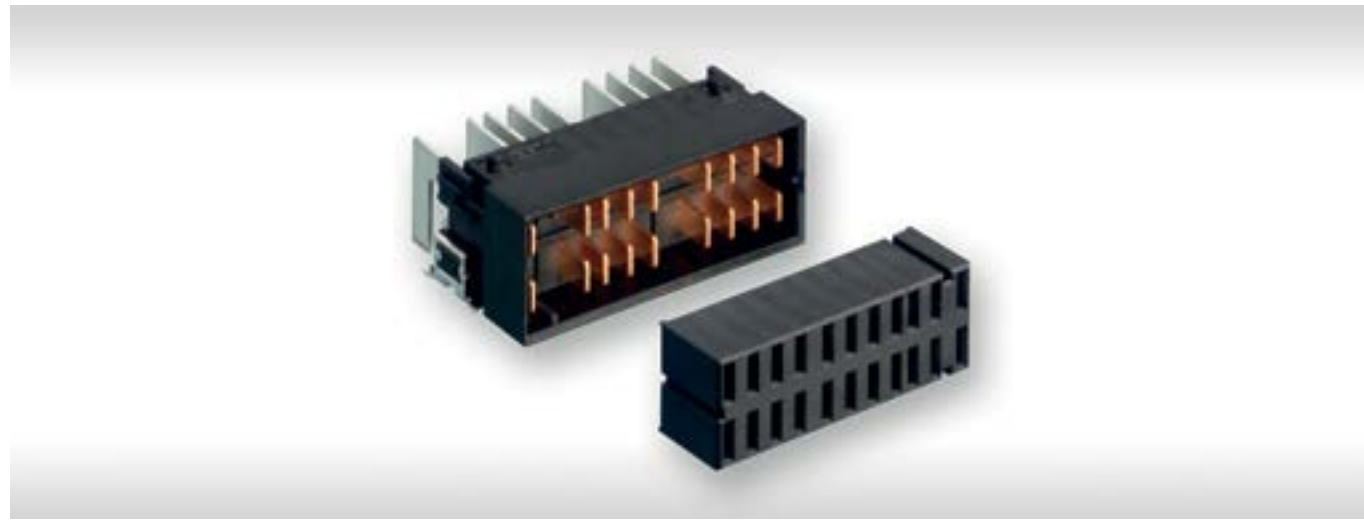

FEATURES

Description	MicroSpeed Power Modules	Power Connectors
No. of Pins	5	- 7 (up to 10 possible) - 9 (up to 22 possible) - 18 (up to 22 possible) - 20 - 32 (up to 44 possible)
Current rating per contact	up to 18 A	up to 15 A
Temperature range	-55 °C to 125 °C	-55 °C to 125 °C
Board-to-Board heights	5 - 20 mm	-
Termination technology	SMT, SMT/ THR and THR	SMT
Applications	orthogonal mezzanine coplanar	orthogonal
Variants	male and female connectors vertical and right angle Non-Blind Mate and Blind Mate shielded	right angle male vertical female

CONCEPT

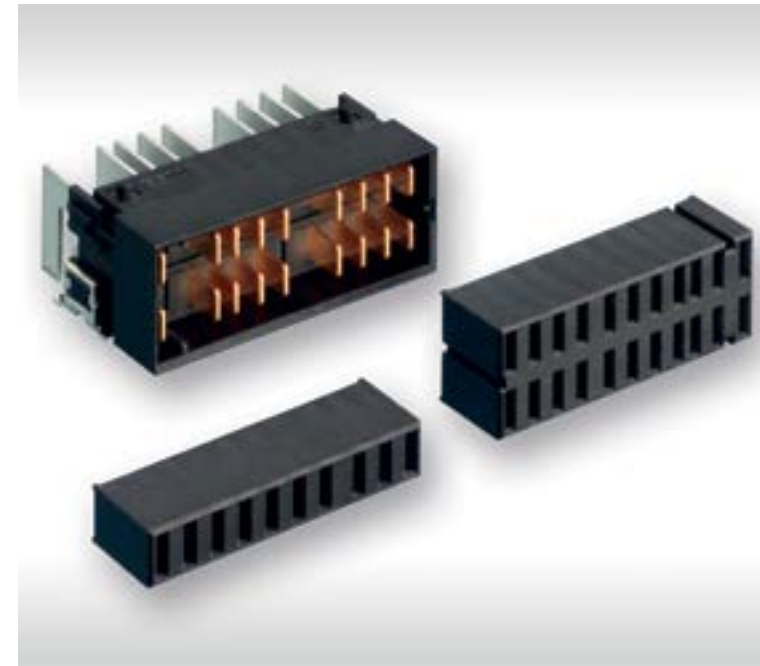

Various Types

- no. of pins:
 - 7 (up to 10 possible)
 - 9 (up to 22 possible)
 - 18 (up to 22 possible)
 - 20
 - 32 (up to 44 possible)
- durability: orthogonal
- unshielded
- current rating up to 15 A per contact at 125 °C limit temperature
- variable contact distance, thus higher operating voltages are possible
- possible selective placement for higher flexibility in the applications

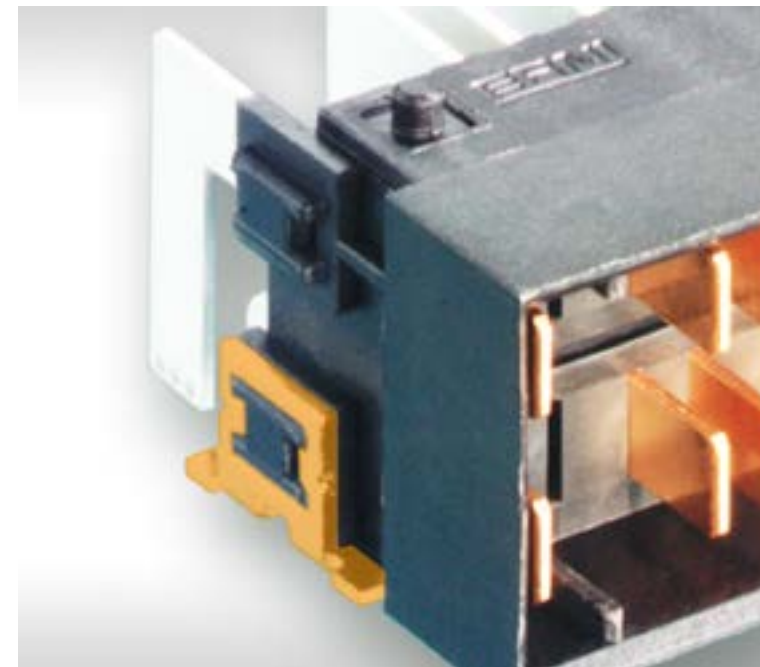

Solder Clips

- robust SMT solder clips for 90° male connectors
- extremely high shear forces due to form-fit mounting in the housing
- strain relief

ELECTRICAL AND MECHANICAL CHARACTERISTICS

Technical Data

Description	Standard	Power Connectors
Climate category	DIN EN 60068-1 test b	55 / 125 / 56
Temperature range		-55 / 125 °C
Current rating per contact	IEC60512 test 5b	up to 15 A
Air- and creepage (min.)		variable
Operating voltage	IEC 60664	The permissible operating voltages depends on the customer application and on the applicable or specified safety requirements. Insulation coordination according to IEC 60664-1 has to be regarded for the complete electrical device. Therefore, the maximum creep- age and clearance distances of the mated connectors are specified for consideration as a part of the whole current path. In practice, reductions in creepage or clearance distances may occur due to the conductive pattern of the printed board or the wiring used, and have to be taken into account separately. As a result the creepage and clearance distances for the application may be reduced compared to those of the connector.
Dielectric strength	IEC 60512 test 4a	contact - contact 750 V _{rms}
Contact resistant	IEC 60512 test 2a	< 4 mΩ
Insulation resistant	IEC 60512 test 3a	> 10 ⁶ MΩ
Vibration, sine	IEC 60512 test 6d	10 - 2000 Hz 20 g
Contact disturbance (while vibration test)	IEC 60512 test 2e	< 1 μs
Mechanical operation	IEC 60512 test 9a	500 mating cycles
Insertion and withdrawal force	IEC 60512 test 13b	< 5 N
Gauge retention force	IEC 60512 test 16e	> 0.5 N
Processing Conditions		
Reflow soldering temperature max.	JEDEC J-STD-020	20 - 40 s at 260 °C
Coplanarity		< 0.1 mm

ELECTRICAL AND MECHANICAL CHARACTERISTICS

Technical Data

Description	Standard	Power Connectors
Housing Material		
Insulation body		PPA
CTI value	IEC 112	600
UL flame rating	UL 94	V-0
UL file plastic material		E53898
MSL	JEDEC J-STD-020	Level 2
Contact Material		
Base material		Cu alloy
Mating area		Gold plating
Termination area		Sn
Environment Compatibility		
Recycling		no flame-retardant additives, no toxic additives allow easy recycling

VERTICAL FEMALE

Product Specification

- unshielded power connectors
- 7, 9, 18, 20, 28, 32 pins
- 1- and 2-row
- current rating up to 15 A per contact
- SMT termination
- tape and reel packaging
- for available part numbers please refer to our website



Dimensional Drawings

20 pin version

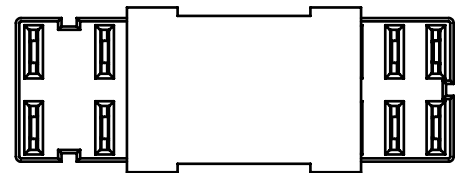
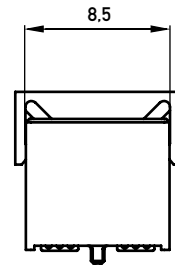
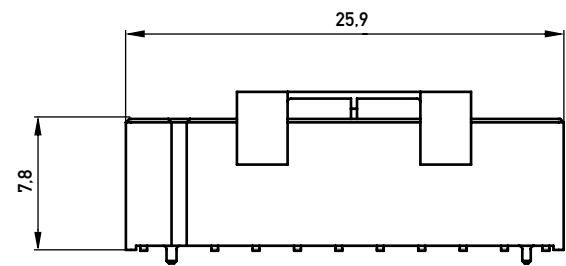

All dimensions in mm

RIGHT ANGLE MALE

Product Specification

- unshielded power connectors
- 7, 9, 18, 20, 28, 32 pins
- 1- and 2-row
- current rating up to 15 A per contact
- SMT termination
- tape and reel packaging
- for available part numbers please refer to our website

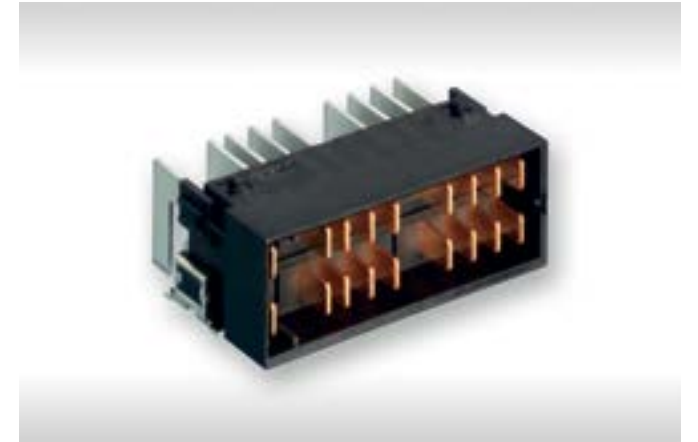

Dimensional Drawings

20 pin version

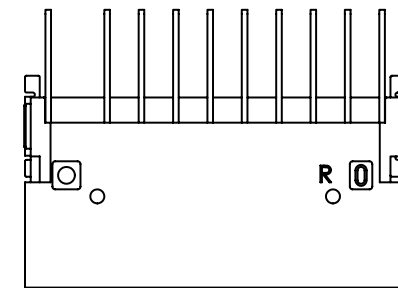
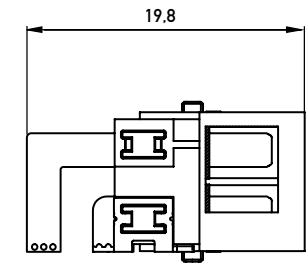
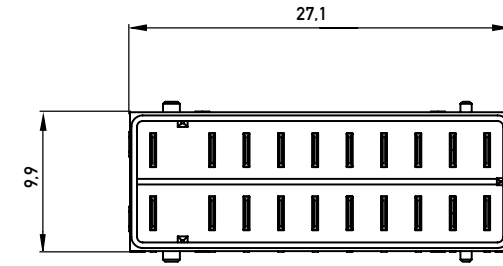

All dimensions in mm

Connect With Us

We make it easy to connect with our experts and are ready to provide the support you need. Visit www.te.com/support to chat with a Product Information Specialist.

te.com

2022 TE Connectivity. All Rights Reserved.

TE Connectivity, TE connectivity (logo) ERNI, MicroSpeed and Every Connection Counts are trademarks owned or licensed by the TE Connectivity family of companies. All other logos, products and/or company names referred to herein might be trademarks of their respective owners.

The information given herein, including drawings, illustrations and schematics which are intended for illustration purposes only, is believed to be reliable. However, TE Connectivity makes no warranties as to its accuracy or completeness and disclaims any liability in connection with its use. TE Connectivity's obligations shall only be as set forth in TE Connectivity's Standard Terms and Conditions of Sale for this product and in no case will TE Connectivity be liable for any incidental, indirect or consequential damages arising out of the sale, resale, use or misuse of the product. Users of TE Connectivity products should make their own evaluation to determine the suitability of each such product for the specific application.

074587 03/22 Original

CATALOG

TE Connectivity

ERNI Electronics GmbH & Co. KG
a TE Connectivity Ltd. company
Seestraße 9
73099 Adelberg
Germany

Tel +49 7166 50-0
www.te.com
www.erni.com

Mouser Electronics

Authorized Distributor

Click to View Pricing, Inventory, Delivery & Lifecycle Information:

[TE Connectivity:](#)

[524551-E](#)