

Type 3522 Series

Key Features

**3 Watts at
70°C**

**Small size to
power ratio**

**Supplied on
tape**

**Value marked
on resistor**

**Available via
distribution**

**500 volt
maximum
overload**

**250 volt
working
voltage**

**Terminal finish
matte Sn over
Ni**

**AEC-Q200
Qualified**



TE Connectivity is pleased to announce that our 3522 series resistor is now AEC-Q200 qualified. This low cost high power device, suitable for auto placement in volume and for most applications, including high frequency operations, owing to the short lead structure is supplied as standard on 7 inch Reels of 2000 pieces per reel.

Characteristics – Electrical

Power rating at 70°C	3W
Rated current (Jumper)	2.5A
Max. overload current (Jumper)	10A
Max working voltage	250V
Max overload voltage	500V
Dielectric withstand voltage	500V
Temperature range	-55°C ~ +155°C
Ambient temperature	70°C

* Rated continuous working voltage (RCWV) shall be determined from

$RCWV = \sqrt{\text{Rated Power} \times \text{Resistance Value}}$, or Maximum RCWV listed above, whichever is less

**Recommended Circuit Board Design - If this device is anticipated to run at full continuous power then action to improve the cooling should be taken. This can be a metal substrate, copper pad left under the chip, an opening in the PCB or enlarged silver conductor pads each end.

Power derating curve

For resistors operated in ambient temperatures above 70°C, power rating must be derated in accordance with this curve.

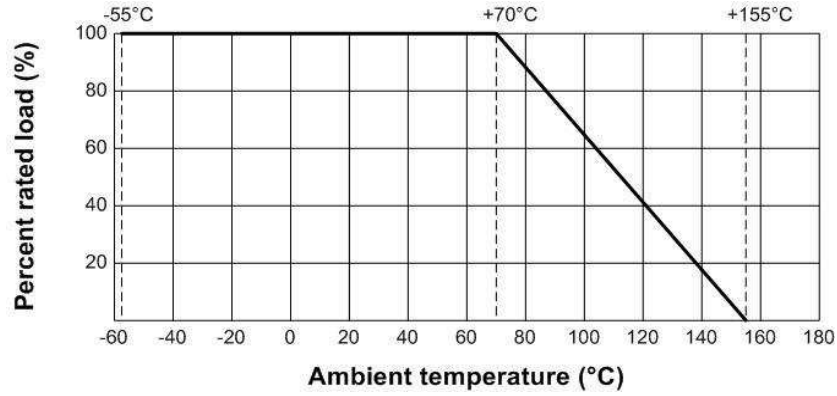

Construction and dimensions

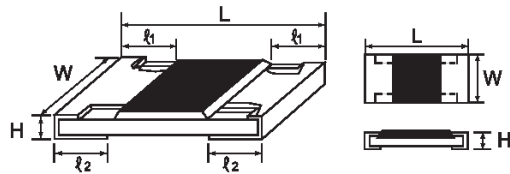
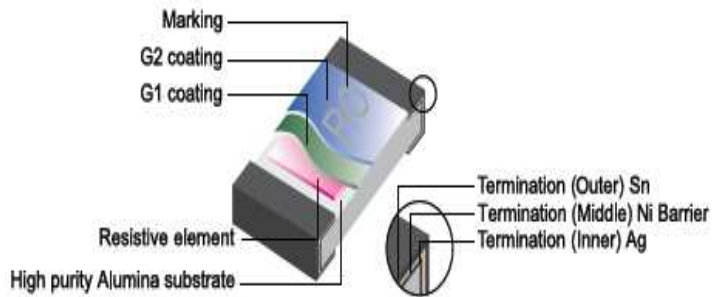

$L \pm 0.10$	$W \pm 0.15$	$H \pm 0.10$	$\ell_1 \pm 0.25$	$\ell_2 \pm 0.20$
6.35	3.20	1.10	0.60	1.80

Power rating @70°C	Tolerance %	Resistance Range	Standard series
3W	Jumper	<50mΩ	
	± 1%	1Ω - 10MΩ	E96
	± 5%	1Ω - 10MΩ	E24

Performance specification

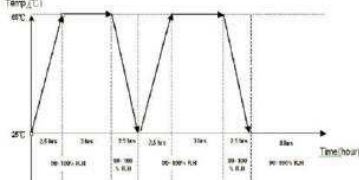
Characteristics	Limits	Test Methods
Operational life	$\pm(1\%+0.1\Omega)\text{max}$	125 \square , at 35% of operating power, 1000H(1.5 hours "ON", 0.5 hour "OFF"). (MIL-STD-202)
	<100m Ω	Apply to rate current for 0 Ω
Temperature Coefficient of Resistance	$1\Omega \leq R \leq 10\Omega \leq \pm 400\text{PPM}/^\circ\text{C}$ $10\Omega < R \leq 100\Omega \leq \pm 200\text{PPM}/^\circ\text{C}$ $100\Omega < R \leq 10\text{M}\Omega \leq \pm 100\text{PPM}/^\circ\text{C}$	Parametrically test per lot and sample size requirements, summary to show Min, Max, Mean and Standard deviation at room as well as Min and Max operating temperatures. (User Spec)
External Visual	No Mechanical Damage	Electrical test not required. Inspect device construction, marking and workmanship (MIL-STD-883 Method 2009)
Physical dimension	Reference 2.0 Dimension standards	Verify physical dimensions to the applicable device detail specification Note: User(s) and Suppliers spec. Electrical test not required. (JESD22 MH Method JB-100)
Resistance to solvent	Marking Unsmearred	Note: Add Aqueous wash chemical – OKEM Clean or equivalent. Do not use banned solvents. (MIL-STD-202 Method 215)
Terminal Strength	Not broken	Force of 1.8kg for 60 seconds. (JIS-C-6429)
High Temperature Exposure (storage)	$\pm(1\%+0.1\Omega)\text{max}$	1000hrs. @T=155 $^\circ\text{C}$. Unpowered. Measurement at 24 \pm 2 hours after test conclusion. (MIL-STD-202 Method 108)
	<50m Ω	Apply to rate current for 0 Ω
Temperature cycling	Resistance change rate is $\pm(0.5\%+0.1\Omega)$ Max	1000 Cycles (-55 $^\circ\text{C}$ to +155 $^\circ\text{C}$). Measurement at 24 \pm 2 hours after test conclusion (JESD22 Method JA-104)
	<50m Ω	Apply to rate current for 0 Ω
Moisture Resistance	Resistance change rate is $\pm(0.5\%+0.1\Omega)$ Max.	 T=24 hours /cycle. Unpowered. Measurement at 24 \pm 2 hours after test conclusion. (MIL-STD-202 Method 106)
	<50m Ω	Apply to rate current for 0 Ω
Biased Humidity	Resistance change rate is $\pm(1\%+0.1\Omega)$ Max.	10% rated power, 85 $^\circ\text{C}$ /85% RH, 1000H, Measurement at 24 hours after test conclusion (MIL-STD-202 Method 103)
	<100m Ω	Apply to rate current for 0 Ω

Characteristics	Limits	Test Methods
Mechanical Shock	$\pm(1\%+0.1\Omega)\text{max}$	Wave Form: Tolerance for half sine shock pulse. Peak value is 100g's. Normal duration (D) is 6. (MIL-STD-202 Method 213)
Vibration	$\pm(1\%+0.1\Omega)\text{max}$	5g's for 20 min., 12cycle each of 3 orientations Note: Use 8"*5"PCB. 031" thick 7 secure points on one long side and 2 secure points at corners of opposite sides. Parts mounted within 2' from any secure point. Test from 10-2000Hz. (MIL-STD-202 Method 204)
Thermal Shock	$\pm(1\%+0.1\Omega)\text{max}$	-55°C/+155°C, Note: Number of cycles required - 300, Maximum transfer time -20 seconds, Dwell time -15 minutes. Air-Air. (MIL-STD-202 Method 107)
	<50mΩ	Apply to rate current for 0Ω
ESD	$\pm(10\%+0.1\Omega)\text{max}$	With the electrometer in direct contact with the discharge tip, verify the voltage setting at levels of $\pm 500\text{V}$, $\pm 1\text{KV}$, $\pm 2\text{KV}$, $\pm 4\text{KV}$, $\pm 8\text{KV}$, The electrometer reading shall be within $\pm 10\%$ for voltages from 500V to $\leq 800\text{V}$. (AEC-Q200-002)
Solderability	95% coverage Min.	For both leaded & SMD. Electrical test not required. Magnification 50X. Conditions: a) Method B 4hrs at 155°C dry heat, the dip in bath with 245°C, 5s. b) Method B: at 215°C, 5s. c) Method D: at 260°C, 60s. (J-STD-002)
Flammability	No ignition of the tissue paper or scorching of the pinewood board	V-0 or V-1 are acceptable. Electrical test not required. (UL-94)
Board Flex	$\pm(1\%+0.05\Omega)\text{max}$	2mm (Min) (JIS-C-6429)
	<50mΩ	Apply to rate current for 0Ω
Flame Retardance	No flame	Temperature sensing at 500°C, Voltage power subjected to 32VDC current clamped up to 500ADC and decreased in 1.0VDC/hour. (AEC-Q200-001)
Resistance to Soldering Heat	$\pm(1\%+0.05\Omega)\text{max}$.	Condition B No per-heat of samples. Note: Single Wave Solder - Procedure 2 for SMD and Procedure 1 for Leaded with solder within 1.5mm of device body. (MIL-STD-202 Method 210)
	<50mΩ	Apply to rate current for 0 W
* Sulfuration test: H2S 3~5PPM 50 ± 2 91%~93%RH 1000H		

Marking:

Marking for E-96 series in 2512 size: 4 digit marking

First three digits are significant figures of resistance and the fourth digit represents the number of following zeros. N.B. For values below 100Ω the letter R denotes decimal point eg. 1R80 = 1.8Ω

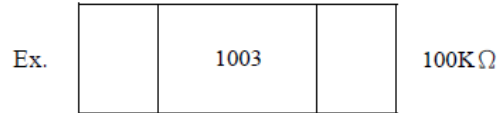

Marking for E-24 series in 2512 size: 3 digit marking

First two digits are significant figures, and the third digit represents the number of zeros

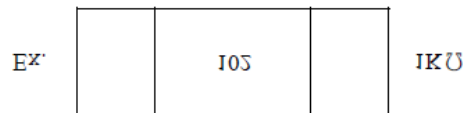

Packing specification:

Taping dimensions (mm)

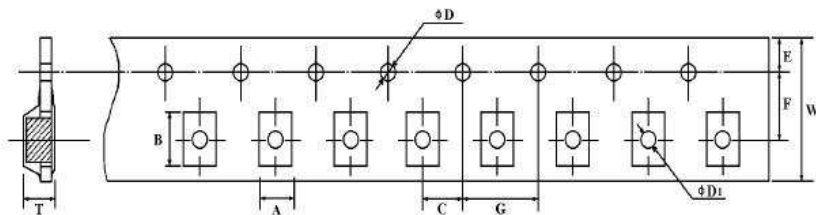

A	B	C	ØD	E	F	G	W	ØD ₁	T
±0.10	±0.10	±0.15	+0.1 -0	±0.10	±0.15	±0.1	±0.30	±0.1	±0.1
3.5	6.7	2.0	1.5	1.75	5.5	4.0	12	1.5	1.35

Peeling strength of Top Cover Tape

Test Condition 0.1 to 0.7 N at a peel-off speed of 300mm / min.

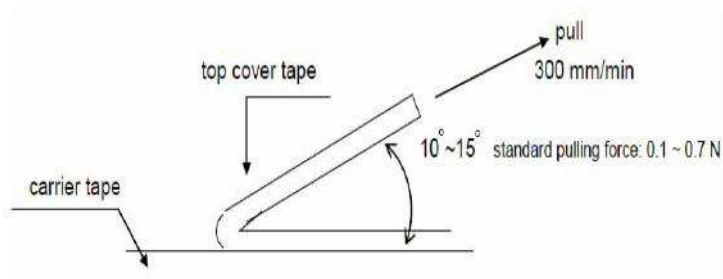

Reel dimension (mm)

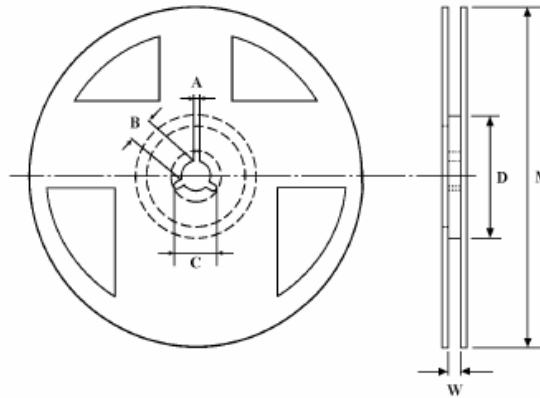

Qty / Reel	A ±0.5	B ±0.5	C ±0.5	D ±1	M ±2	W ±1
2000	2	13	21	60	178	13.5

Environment Related Substance

This product complies to EU RoHS directive, EU PAHs directive, EU PFOS directive and Halogen free.

Ozone layer depleting substances.

Ozone depleting substances are not used in our manufacturing process of this product.

This product is not manufactured using Chlorofluorocarbons (CFCs), Hydrochlorofluorocarbons (HCFCs), Hydrobromofluorocarbons (HBFCs) or other ozone depleting substances in any phase of the manufacturing process.

Storage Condition

The performance of these products, including the solderability, is guaranteed for a year from the date of arrival at your company, provided that they remain packed as they were when delivered and stored at a temperature of $25^{\circ}\text{C} \pm 10^{\circ}\text{C}$ and a relative humidity of $60\%\text{RH} \pm 10\%\text{RH}$, chemical and dust free atmosphere

Even within the above guarantee periods, do not store these products in the following conditions, otherwise, their electrical performance and/or solderability may be deteriorated, and the packaging materials (e.g. taping materials) may be deformed or deteriorated, resulting in mounting failures.

1. In salty air or in air with a high concentration of corrosive gas, such as Cl_2 , H_2S , NH_3 , SO_2 , or NO_2
2. In direct sunlight

Recommended solder pad

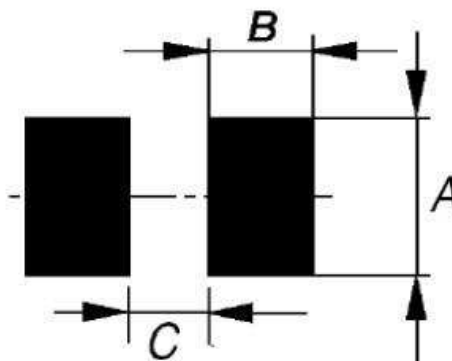

A	B	C
3.70	3.30	2.70

4 layers PCB specification:

- 1) Outside 2 layers (Top and Bottom) with copper foil thickness at 2oz.
- 2) Inside 2 layers (Middle layers) with copper foil thickness at 4 oz.

AEC-Q200

The 3522 series is qualified to AEC-Q200 standard at Grade"4"

How To Order

3522	1K0	F	T
Common Part	Resistance Value	Tolerance	Pack Style
3522	1 ohm 1R0 1K ohm 1000 ohms 1K0 1 Meg ohm 1000000 ohms 1M0	F – 1% J – 5%	T – 2000 reel

Mouser Electronics

Authorized Distributor

Click to View Pricing, Inventory, Delivery & Lifecycle Information:

[TE Connectivity:](#)

[35221K2JT](#)