

85

Compensated

Specifications

- **316L SS Pressure Sensor**
- **Small Profile**
- **0 - 100mV Output**
- **Absolute and Gage**
- **Temperature Compensated**

The 85 compensated is a small profile, media compatible, piezoresistive silicon pressure sensor packaged in a 316L stainless steel housing. The 85 compensated is offered in a weldable package or with a variety of threaded fittings such as 1/4 and 1/8NPT, 1/4BSP as well as custom process fittings.

The 85 compensated is designed for OEM applications where compatibility with corrosive media is required. The sensing package utilizes silicon oil to transfer pressure from the 316L stainless steel diaphragm to the sensing element. A ceramic substrate is attached to the package that contains laser-trimmed resistors for temperature compensation and offset correction. An additional laser trimmed resistor is included which can be used to adjust an external differential amplifier and provide span interchangeability to within $\pm 1\%$.

Please refer to the 85 uncompensated and constant voltage datasheets for more information on different features of the 85

Features

- Weldable/Threaded Process Fittings
- -40°C to +125°C Operating Temperature Range
- Up to $\pm 0.1\%$ Pressure Non-Linearity
- Solid State Reliability
- 1.0% Interchangeable Span (provided by gain set resistor)

Applications

- Medical Instruments
- Process Control
- Fresh & Waste Water Measurements
- Partial Vacuum Gas Measurement
- Pressure Transmitters
- Tank Level Systems (RV & Industrial)

CLICK HERE ›
CONNECT WITH A SPECIALIST

Specifications

Unless otherwise specified, Supply Current: 1.5mA; Ambient Temperature: 25°C

PARAMETERS	005PSI			≥015PSI			UNITS	NOTES
	MIN	TYP	MAX	MIN	TYP	MAX		
Span	50	100	150	75	100	150	mV	1
Zero Pressure Output	-2.0	0	2.0	-1.0	0	1.0	mV	2
Pressure Non-Linearity	-0.20	-	0.20	-0.10	-	0.10	%Span	3
Pressure Hysteresis	-0.10	±0.02	0.10	-0.05	±0.02	0.05	%Span	
Repeatability	-	±0.02	-	-	±0.02	-	%Span	
Input Resistance	2.5K	3.5K	6.5K	2.0K	3.5K	5.8K	Ω	
Output Resistance	4.0K	-	7.0K	4.0K	-	6.0K	Ω	
Temperature Error – Span	-1.0	-	1.0	-0.75	-	0.75	%Span	4
Temperature Error – Offset	-2.5	-	2.5	-0.50	-	0.50	%Span	4, 5
Thermal Hysteresis – Span	-0.25	±0.05	0.25	-0.25	±0.05	0.25	%Span	4
Thermal Hysteresis – Offset	-0.25	±0.05	0.25	-0.25	±0.05	0.25	%Span	4
Long Term Stability – Span	-	±0.10	-	-	±0.10	-	%Span/Year	
Long Term Stability – Offset	-	±0.25	-	-	±0.10	-	%Span/Year	
Supply Current	0.5	1.5	2.0	0.5	1.5	2.0	mA	6
Output Load Resistance	5M	-	-	5M	-	-	Ω	7
Insulation Resistance (50Vdc)	50M	-	-	50M	-	-	Ω	8
Output Noise (10Hz to 1KHz)	-	1.0	-	-	1.0	-	μV p-p	
Response Time (10% to 90%)	-	-	0.1	-	-	0.1	ms	
Pressure Overload	-	-	3X	-	-	3X	Rated	9
Pressure Burst	-	-	4X	-	-	4X	Rated	10
Compensated Temperature	0	-	50	-20	-	85	°C	
Operating Temperature	-20	-	70	-40	-	125	°C	11
Storage Temperature	-50	-	125	-50	-	125	°C	11

Media – Pressure Port

Liquids and Gases compatible with 316/316L Stainless Steel

Notes

- For amplified output circuits, 3.012V ±1% interchangeability with gain set resistor. See application schematic.
- Measured at vacuum for absolute (A), ambient for gage (G).
- Best fit straight line.
- Over the compensated temperature range with respect to 25°C.
- 15psi range sensors have a temperature error – offset of ±0.75% (max).
- Guarantees output/input ratiometricity.
- Load resistance to reduce measurement errors due to output loading.
- Between case and sensing element.
- The maximum pressure that can be applied without changing the transducer's performance or accuracy.
- The maximum pressure that can be applied to a transducer without rupture of either the sensing element or transducer.
- Maximum temperature range for product with standard cable and connector is -20 to +105°C.
- Standard Gage Units are not recommended for vacuum applications. For vacuum applications below 1/2 atmosphere, consult factory.
- Device marking:
Each part shall be identified with Model Number, Pressure Range, Type, lot Number, Serial number and Date Code.
- Shipping/packaging requirements:
The stainless steel diaphragm is protected by a plastic CAP. Each unit will be package individually in a plastic vial with anti-static foam
- Direct mechanical Contact with diaphragm is prohibited. Diaphragm surface must remain free of defects (scratches, punctures, dents, fingerprints, etc.) for device to operate properly. Caution is advised when handling parts with exposed diaphragms. Use protective cap whenever devices are not in use.

Dimensions

Dimensions are in inches [mm]

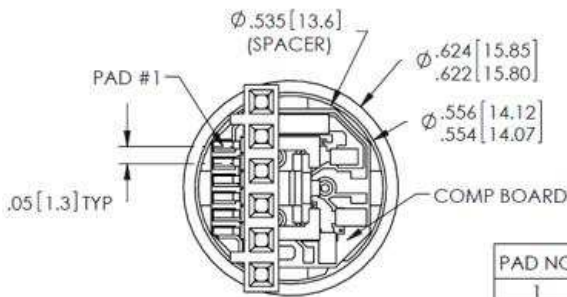
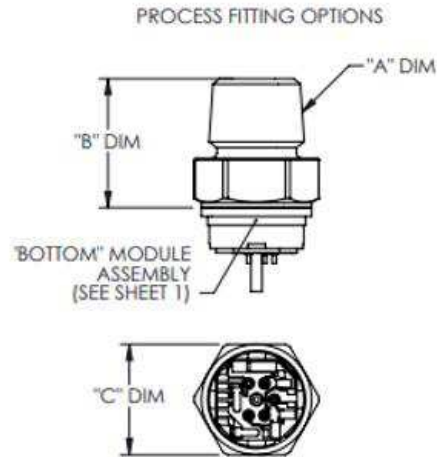
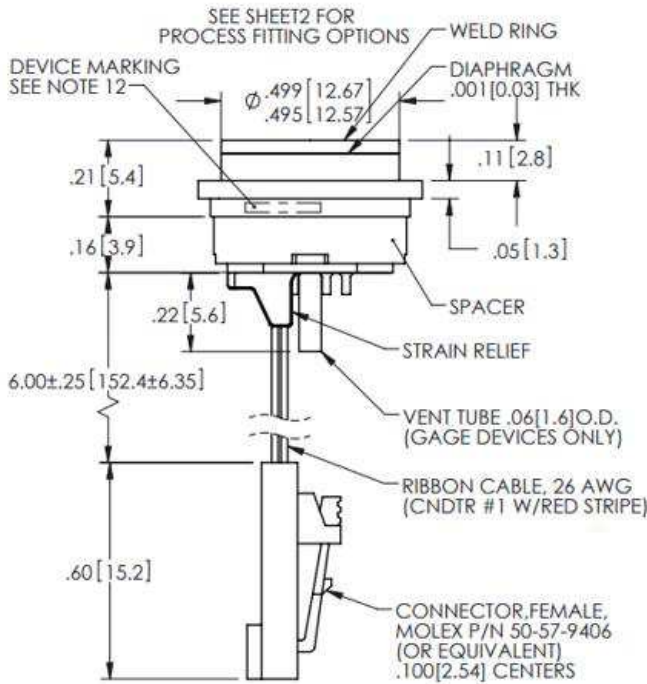

VIEW SHOWN W/O CABLE AND CONNECTOR FOR CLARITY

PAD NO	FUNCTION
1	+OUT
2	-EX
3	+EX
4	-OUT
5	GAIN
6	

FITTING DIMENSIONS			
FITTING TYPE	"A" DIM	"B" DIM	"C" DIM
1	1/4-18 NPT	.99 [25.1]	7/8 [22.2] HEX
2	1/8-27 NPT	.96 [24.4]	7/8 [22.2] HEX
3	7/16-20 UNF	.81 [20.6]	7/8 [22.2] HEX
4	1/4-18 NPT	.73 [18.5]	5/8 [15.9] HEX
5	1/4-19 BSP	.76 [19.3]	3/4 [19.0] HEX
8	1/8-27 NPT	.60 [15.2]	5/8 [15.9] HEX
9	1/4-19 BSP	.94 [23.9]	7/8 [22.2] HEX

NOTE : FTG TYPE '4' ASSEMBLY SHOWN
ALL DIMS ARE FOR REFERENCE

Recommended mounting dimensions

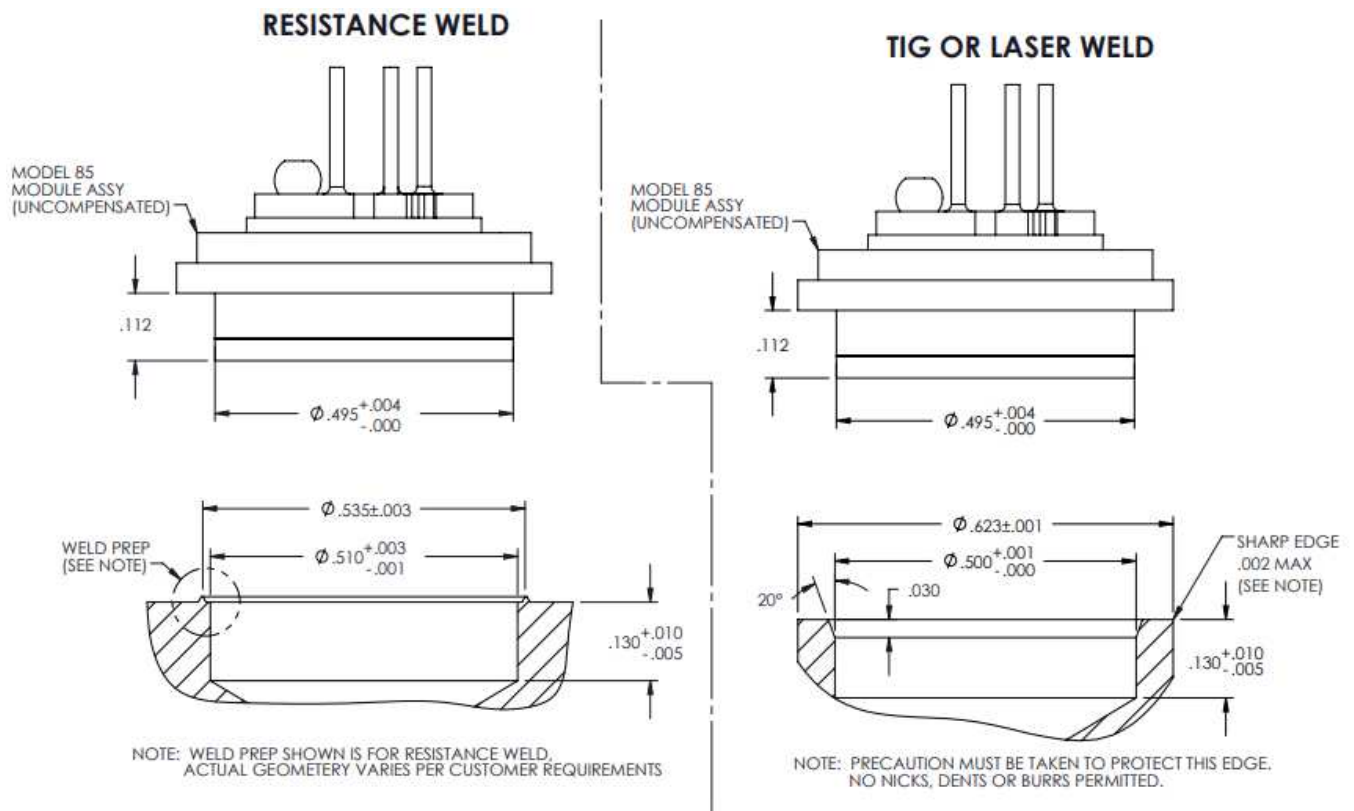

Application schematic

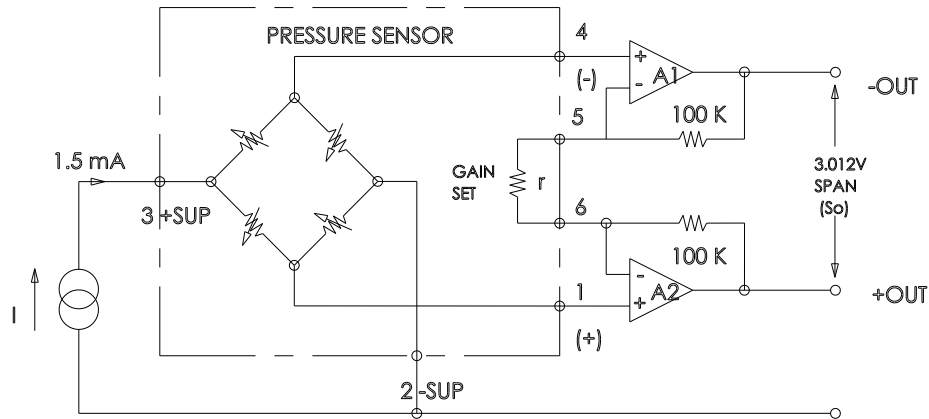

Ordering information

Part Number
85 – 030 G – 8 C I

Pressure Range [psi]	
005	
015	
030	
050	
100	
300	
500	

Pressure Type	
G	Gage
A	Absolute

Vent	
T	Tube
[Blank]	No Tube

Electrical	
R	Ribbon cable
C	Cable W Connector
P	Solder Pads

Fitting Type	
Code	Port Type
0	Weldable, No thread
1	1/4 NPT, 7/8 HEX
2	1/8 NPT, 7/8 HEX
3	7/16 UNF, 7/8 HEX
4	1/4 NPT, 5/8 HEX
5	1/4 BSP, 3/4 HEX
8	1/8 NPT, 5/8 HEX
9	1/4 BSP, 7/8 HEX

Refer to Fitting Table for more information

[CLICK HERE >](#)
CONNECT WITH A SPECIALIST

NORTH AMERICA
Tel +1 800 522 6752

EUROPE
Tel +31 73 624 6999

ASIA
Tel +86 0400 820 6015

te.com/sensors

TE Connectivity, TE, TE Connectivity (logo) and Every Connection Counts are trademarks. All other logos, products and/or company names referred to herein might be trademarks of their respective owners

The information given herein, including drawings, illustrations and schematics which are intended for illustration purposes only, is believed to be reliable. However, TE Connectivity makes no warranties as to its accuracy or completeness and disclaims any liability in connection with its use. TE Connectivity's obligations shall only be as set forth in TE Connectivity's Standard Terms and Conditions of Sale for this product and in no case will TE Connectivity be liable for any incidental, indirect or consequential damages arising out of the sale, resale, use or misuse of the product. Users of TE Connectivity products should make their own evaluation to determine the suitability of each such product for the specific application.

© 2021 TE Connectivity Corporation. All Rights Reserved.

Version A7 02/2021



Mouser Electronics

Authorized Distributor

Click to View Pricing, Inventory, Delivery & Lifecycle Information:

[TE Connectivity:](#)

[85-100A-4R](#)