

AVH Series –Anti-Vandal High Current Pushbutton Switches

Applications

- Machinery.
- Automotive Electronics.
- Strict Access Control Systems.
- Shipping Equipment.
- Medical Equipment.
- Horticulture.
- Bath Accessories.



The AVH Series addresses high current applications. These high-quality Anti-Vandal switches are available in 19mm, 22mm and 25mm diameter bushings for a wide range of possible applications. In addition, AVH Series provide more options for operating, LED light types, light colors and LED voltages to fulfill the variety requirements.

The AVH Switches are characterised by contact rating of 16A, 26A/ 125, 250VAC.

Reference TE Customer Drawing for application instructions.

Features

- High current, 16A & 26A are available.
- Flat Button Type.
- Momentary and Locking Actuation Available.
- Independent LED Control (7 color options).
- Bushing sizes, 19, 22 & 25mm are available.
- UL Recognized.

AVH Series – Type Classification

Type	AVH19	AVH22	AVH25
Bushing Size	19mm	22mm	25mm
Actuation	Momentary / Locking		
Rating	16A, 26A/ 125, 250VAC		
Contact Resistance	50mΩ Max.		
Operation Temperature	-25°C to 85°C		
Mechanical Life	1,000,000 cycles, Momentary 500,000 cycles, Locking		
Electrical Life	50,000 cycles, 16A 10,000 cycles, 26A		
Sealing	Silicone		
Operation Force	3.5±1.5N		
Travel	3.2mm		
Ingress Protection	IP67, IK08		
Pollution Degree	2, Marco and Micro		

s

Bushings Types:

19mm

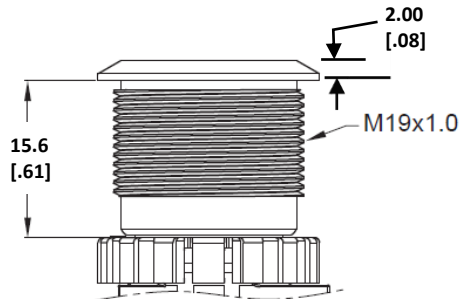

Panel Cut-out

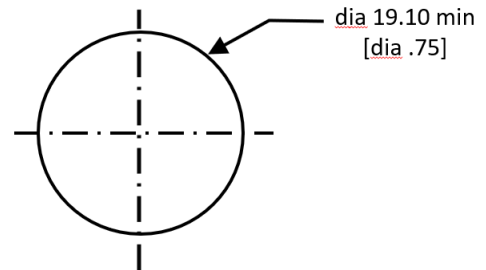

Panel Thickness: 10.0mm [.39] Maximum.

22mm

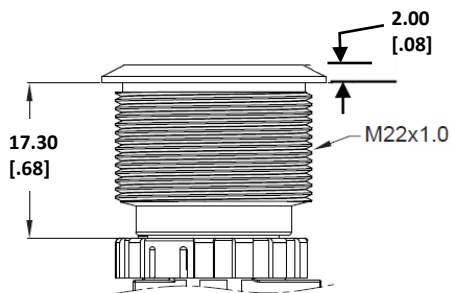

Panel Cut-out

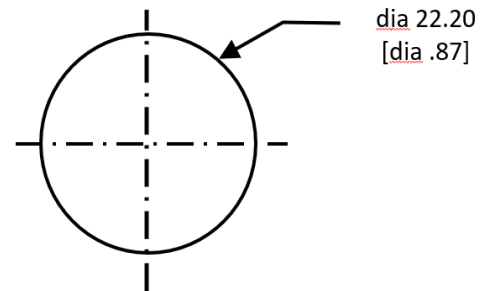

Panel Thickness: 10.0mm [.39] Maximum.

25mm

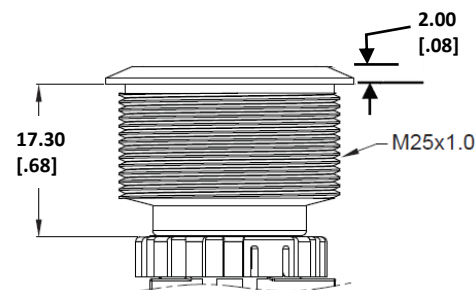

Panel Cut-out

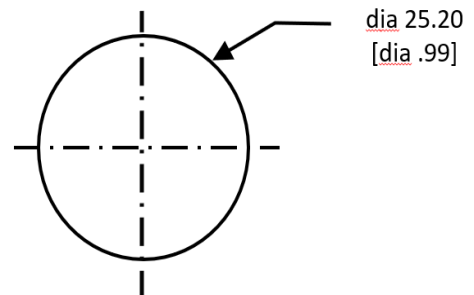

Panel Thickness: 10.0mm [.39] Maximum.

LED Light Types:

19mm

“O” Without LED

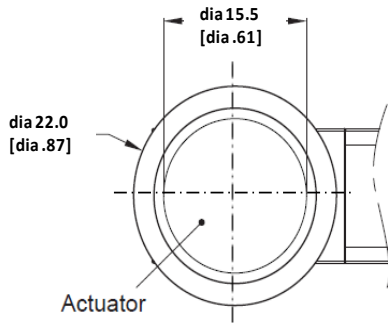

“R” Ring, moving

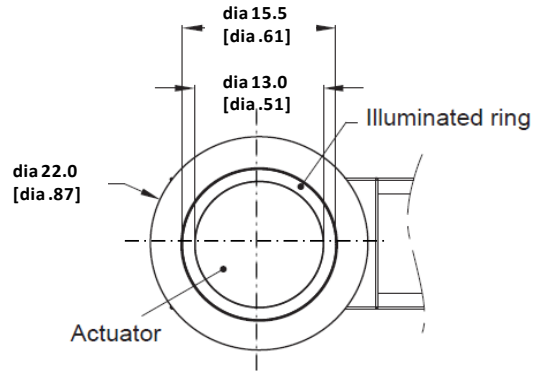

“P” Power Symbol

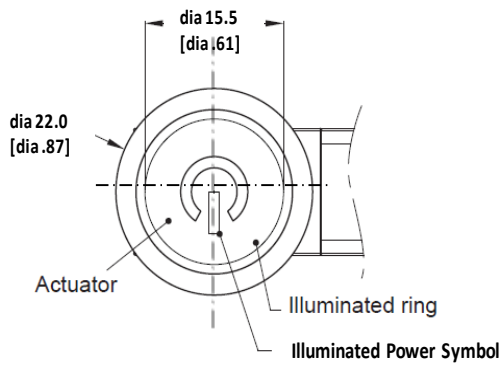

“E1” Ring + Power Symbol

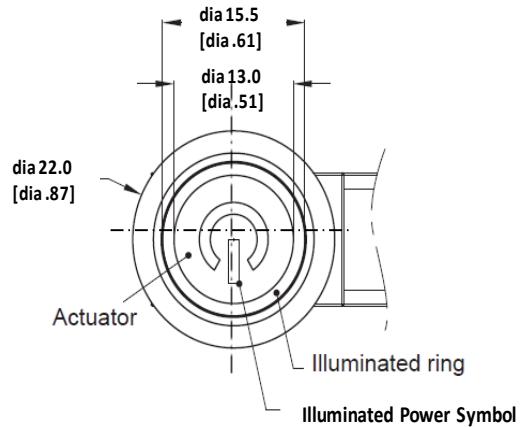

22mm

“O” Without LED

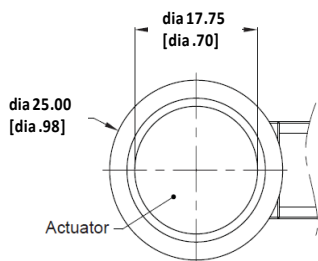

“R” Ring

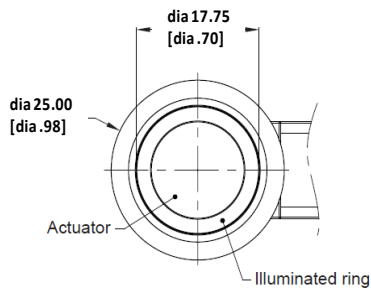

“P” Power Symbol

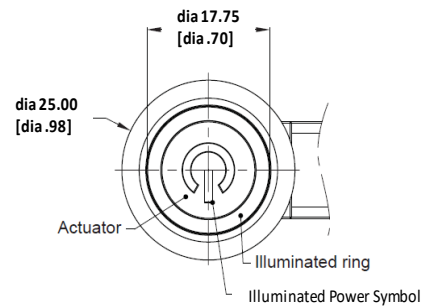

25mm

“O” Without LED

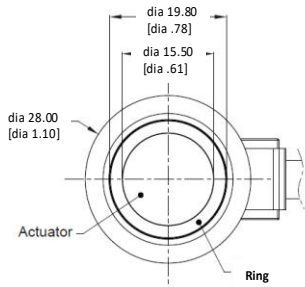

“R” Ring

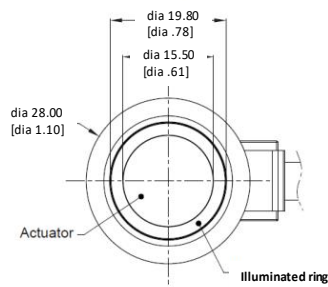

“P” Power Symbol

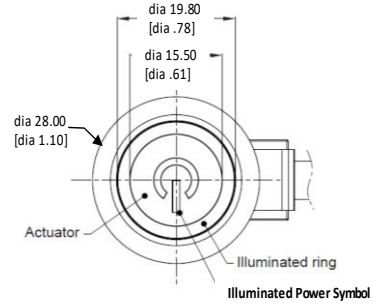

Terminal Types:

“16” #187 terminal, 16A

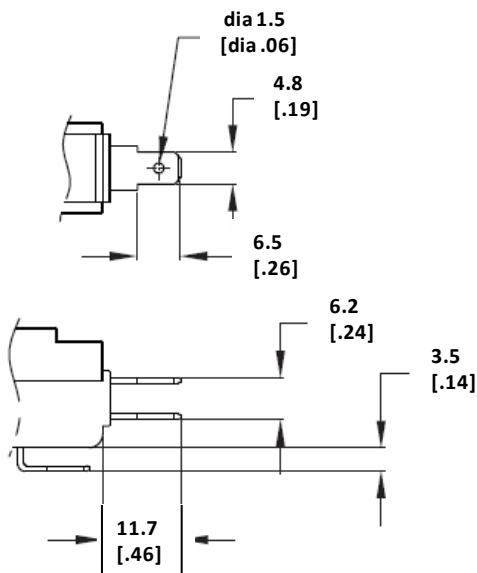

“26” #250 terminal, 26A

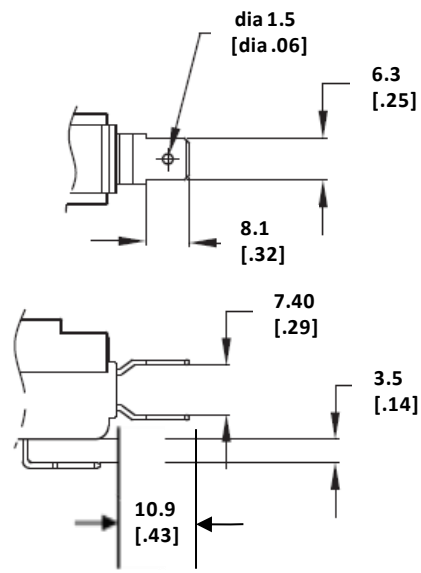

Circuit Types:

No LED



Position 1

LED

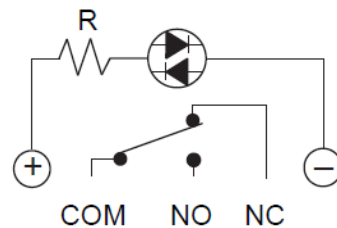

Position 1



Part numbering – How to order

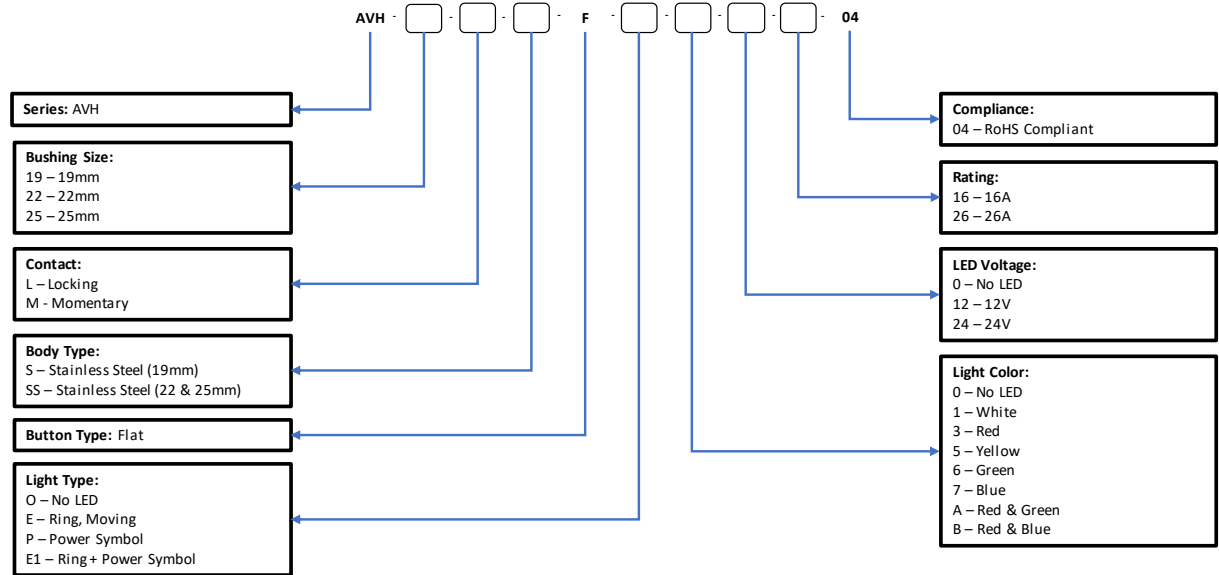

-Example PN: AVH19MSFE3122604

Mouser Electronics

Authorized Distributor

Click to View Pricing, Inventory, Delivery & Lifecycle Information:

[TE Connectivity:](#)

[AVH19MSFE5241604](#)