



# 69XXN SERIES WIRELESS LORAWAN PRESSURE TRANSDUCER

## General Description

The 69XXN is a high accuracy wireless transducer that eliminates hard wiring and provides remote monitoring via LoRaWAN™ wireless communication with simple device configuration through Bluetooth Low Energy connection. This series is suitable for measurement of liquid or gas pressure, even for difficult media such as contaminated water, steam, and mildly corrosive fluids.

The 69XXN is certified to:

IS Class I, Division 1 Groups A, B, C, D, T4

Class I Zone 0, AEx ia IIC T4 Ga

Ex ia IIC T4 Ga; Ta / Process Temp: -30 °C to +75 °C

The wetted material of the pressure port is made of 316L stainless steel and the transducer's durability is excellent with no O-rings or organics exposed to the pressure media. The 69XXN is weatherproof and exceeds the latest heavy industrial CE requirements.



## Features

- Multiple wireless communications options including LoRaWAN™ (868 MHz (EU) / 915 MHz (NA) and Bluetooth Low Energy
- Lightweight and small form factor
- Programmable thresholds for event detection
- Easy device configuration via TE SensorConnect smartphone application
- Explosive atmosphere certified
- Programmable and customer configurable
- BSPP / NPT thread options available

## Applications

- Oil well monitoring
- Pipeline monitoring
- Corrosive fluids and gas measurement systems
- Condition monitoring

## Key Specifications

- Supports pressure ranges from 2 to 350 bar (30 to 5000 PSI)
- 18-month typical battery life @ 1 min Tx / measure intervals in temperatures from 0°C to 40°C
- 12-month typical battery life @ 1 min Tx / measure intervals in temperatures from -20°C to 40°C
- 8-year typical battery life @ 10 min Tx / measure intervals in temperatures from 0°C to 40°C
- Max weight: 170g (with battery)
- Accuracy as high as ±0.1%FS
- 868MHz (EU) /915MHz (USA) frequencies
- Weatherproof (IP66/IP67)
- Wide operating temperature range from -30°C to 75°C
- Rugged construction can withstand 50g shock/ 8g vibration.

[CLICK HERE >](#)  
**CONNECT WITH A SPECIALIST**

# 1 PERFORMANCE SPECIFICATIONS

## 1.1 Standard ranges:

Pressure Range (Bar)	Pressure range (psi)	Absolute
0 to 2	0 to 30	•
0 to 7	0 to 100	•
0 to 20	0 to 300	•
0 to 35	0 to 500	•
0 to 200	0 to 2900	•
0 to 350	0 to 5000	•

## 1.2 Absolute maximum ratings <sup>(1)</sup>:

Parameter	Symbol	Min	Typ.	Max	Unit	Notes/Conditions
Supply voltage	VDD			3.6	V	Reference to Ground
VDD to GND		-0.3		3.9	V	
Shock limit	$g_{max}$		50		g	Half sine shock per MIL-STD-202F, Method 213B, Condition A
ESD			4		kV	Contact Discharge

<sup>(1)</sup> Maximum limits which the sensor will withstand without damage

## 1.3 Operation specification:

Unless otherwise specified, all parameters are measured at 25°C @ 3.0V applied.

Parameter	Symbol	Min	Typ.	Max	Unit	Notes/Conditions
Accuracy 0 to 35 bar		-0.1%		+0.1%	%Span	RSS combined linearity, hysteresis, and repeatability.
Accuracy 0 to 350 bar		-0.25%		+0.25%	%Span	
Pressure cycles		1.00E+06			0-FS Cycles	
Burst pressure		4X			Rated	
Proof Pressure		3X			Rated	
Long term stability			±0.1		%Span/ year	
Total error band		-1		1	%Span	
Resolution			16		bits	

## 1.4 Environmental specifications:

Parameter	Symbol	Min	Typ.	Max	Unit	Notes/Conditions
Operating temperature	T°	-30		+75	°C	
Ambient humidity	%RH	0		95	%	
Atmosphere pressure		250		1400	mbar	
Ingress protection	IP	IP66/67				
EMI/RFI/ESD protection		IEC61000-4-2, ICE61000-4-6				
Storage temperature		According to IEC 60721-3-1:2018 Class 1K22				Without battery/ 85 %RH Max
Vibration		8g 7Hz-200Hz				

**1.5 Communication specification (BLE):**

Parameter	Symbol	Min	Typ.	Max	Unit	Notes/Conditions
Wireless protocol		BLE 5.0				
Operating frequency BLE		2.4			GHz	
Receiver sensitivity		-129		-127	dBm	
Advertising interval			1		sec	Factory default configuration
Transmit power	Max	+4			dBm	

**1.6 Communication specification (LoRa):**

Parameter	Symbol	Min	Typ.	Max	Unit	Notes/Conditions
Wireless protocol		LoRaWAN™ class A				
Operating frequency LoRaWAN™		868 (EMEA) 915 (USA)			MHz	
Transmit power	Max	+8			dBm	

**1.7 Physical:**

Parameter	Symbol	Min	Typ.	Max	Unit	Notes/Conditions
Media compatibility		External exposed surfaces: 316 stainless steel PET GF EPDM O-ring				
Weight	Max	155±10			g	(without battery)
Dimension		See section 7			mm	
Mounting		Wrench size: 1-7/16in or 36mm				Refer to the installation manual (Doc# 20027955-01)

**1.8 Compliance/regulatory:**

Compliance Type	Notes/Conditions
Bluetooth Signal Compliance	Worldwide application
LoRaWAN™ Certification	North America 915 MHz Europe and middle east (EMEA) 868 MHz
FCC Certified	United States
ISED Certified	Canada
RED Compliance	Europe (EU)
RoHS Compliance	
REACH Compliance	
Explosive Atmospheres Certifications	United States, Canada, ATEX, IECEx
CE Certification	Europe (EU)
UKCA Certification	Great Britain
NCC Certification	Nigeria (Refer to the Order TCPN for the references with Nigerian certification)

## 2 INTRINSIC SAFETY MODELS:

This equipment is certified for Intrinsic Safety when model code “EX” is selected during the ordering process. Please see ordering information in section 8 for details:

Intrinsic Safety approval is as follows:

IS Class I, Div1, Groups A, B, C, and D;  
 Class I Zone 0, AEx ia IIC T4 Ga;  
 Ex ia IIC T4 Ga;



## 3 GENERAL DESCRIPTION:

Refer to the User Manual (Doc# 20027955-11) for a detailed explanation of all sensors features and functions.

- **Block diagram/schematic:**

The system operates as a smart device. It offers sensor acquisition, data processing, analysis, and wireless communication capabilities.

Processing and analysis functions offer the end user flexibility and cover most applications.

The device computes pressure data in a smart way:

- Delta detection
- Raw data

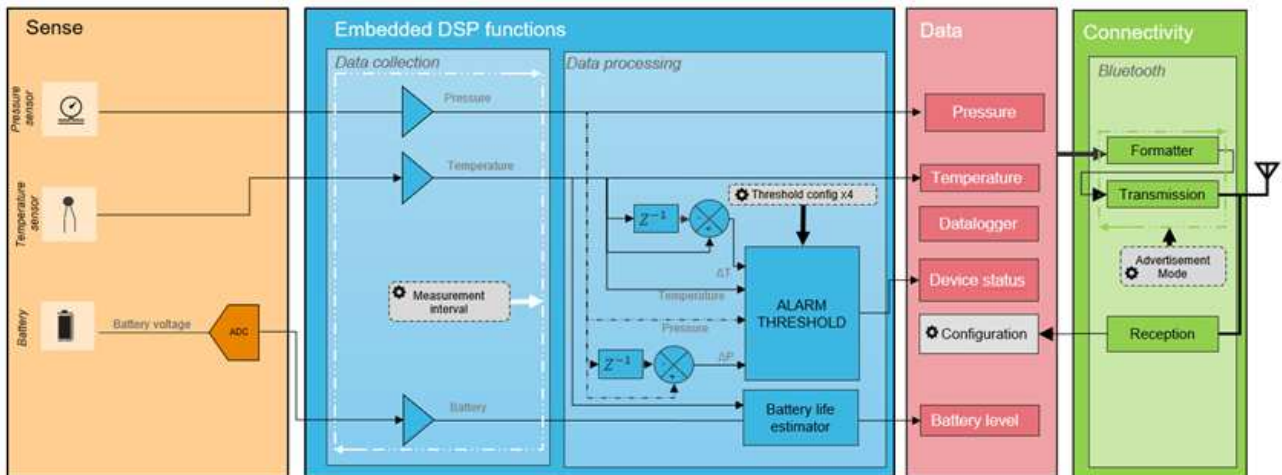

BLE can be used for local configuration for 1 hour.

LoRaWAN™ connectivity will be used to send sensor data periodically. Once configured and connected to a LoRaWAN™ network, the downlink frame can then be used to configure the sensor.

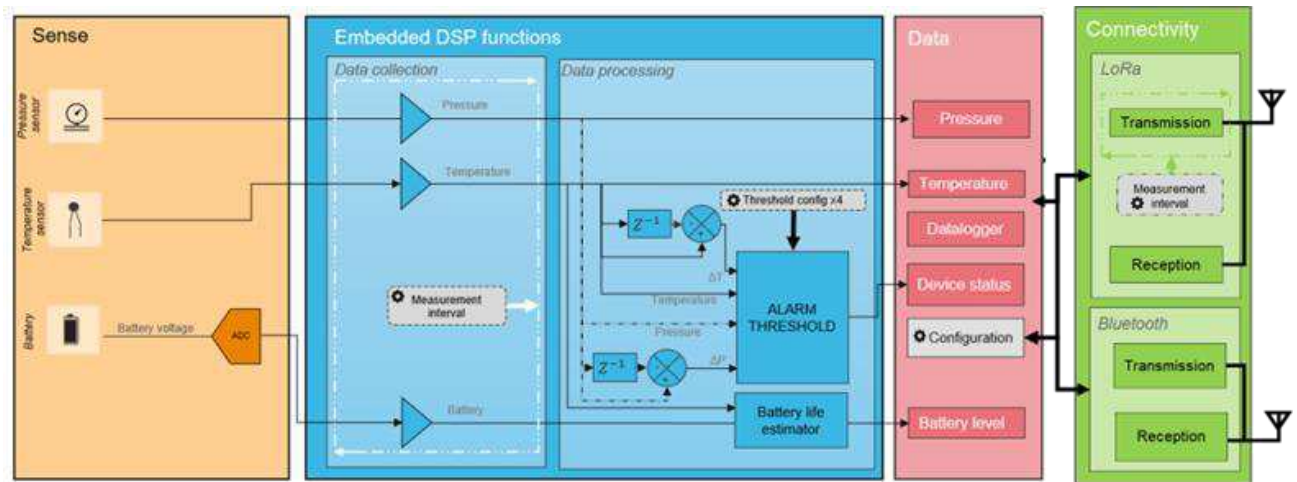

**!The temperature provided is used for internal processing and should not be used as accurate temperature data!**

## 4 BATTERY:

### 4.1 Saft LS17330:

The system should be exclusively powered with an LS17330 battery.

Parameters	Typical value
Manufacturer	SAFT
Reference	LS 17330
Technology	Primary lithium-thionyl chloride (Li-SOCl <sub>2</sub> )
Nominal voltage	3.6 V
Capacity at 20°C	2100 mA

### 4.2 Battery life:

The 69XXN Pressure sensor is designed to use battery power in the most efficient ways possible. Battery quality, long term ambient temperature conditions, data collection and transmission intervals, and spreading factor will impact overall battery life.

- **Battery Quality** – Batteries for the sensor must be acquired from authorized distributors and sources. This ensures that batteries have been stored and transported in temperature conditions that do not exceed the manufacturer’s recommended limits. End users must also store batteries within these temperature limits. If batteries are exposed to temperatures exceeding recommended limits, battery life will be affected.
- **Ambient Temperature Conditions** – Optimum battery life can be expected when the ambient temperature is near 25°C. In most applications, the temperature will vary within the specified limits. These variations can shorten battery life.
- **Data Collection and Transmission Intervals** – The sensor consumes the most power when it is taking measurements, processing the data, and transmitting the information via radios. The user can select the intervals for these actions. Longer intervals will consume less battery power and result in longer battery life.
- **Spreading Factor** – This impacts communication performance of the LoRaWAN™ radio. A larger spreading factor increases the time on air, increases receiver sensitivity, reduces data rate, all to improve communication range. Higher spreading factors will consume more battery energy shortening battery life.
- Under the most ideal conditions, a battery life of 8 years is expected. However, each application will have conditions that are something less than ideal.

### 4.3 Battery replacement:

The 69XXN's battery must be replaced if depleted.

N.B.: It is only allowed to replace the battery in non-hazardous areas.

- Remove the plastic cover following the opening direction
- Use the orange ribbon to pull out the battery
- Put the orange ribbon back in the cavity before installing the new battery. Note that it MUST be replaced by the same battery reference 3.6 V SAFT battery LS17330.
- Put the spacer on the negative terminal and install the battery positive upward
- Pull the spacer out
- Install the plastic cover and tighten it following the locking direction. Refer to the Installation Manual or the Quick start guide for details of battery installation and replacement.

Once the battery replacement is completed, the battery life estimator in the firmware must be reset to a “full” battery status. The battery status can be reset using the TE SensorConnect App available from Apple App Store or Google Play Store.

!This action is mandatory otherwise the battery level will stay at 0%!

## 5 MAGNETIC SWITCH:

If the user wants to make an asynchronous data acquisition, or access to BLE connected mode, they can use the magnet. The magnet event will trigger a measurement, then the sensor will be in Preliminary Phase.

The magnetic switch location is indicated by the magnet drawing on the plastic cover.

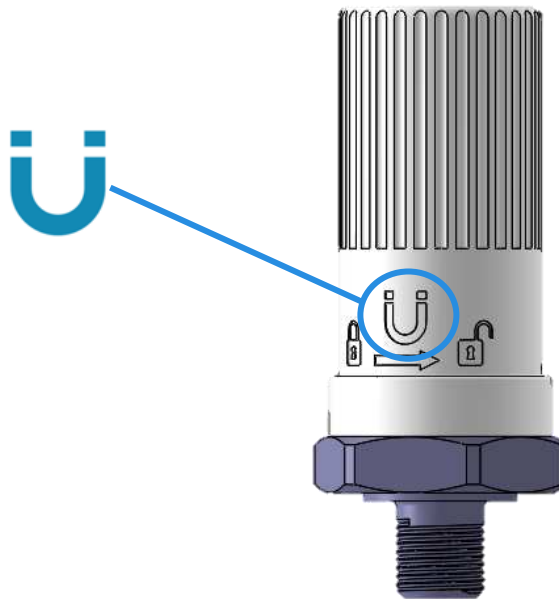

The magnet must be of sufficient strength and proximity to create a magnetic field of 25 mT at the switch location.

Two different functions are available depending on the user action:

Function	User action	LED
Activates BLE for another one hour plus triggers a new measurement.	Short tap	One fast blink. If user holds the magnet close to the switch for a longer duration, the LED will blink faster. Remove the magnet to only initiate a transmission, or else a sensor reset will be initiated.
Resets the sensor	Hold the magnet for 10 seconds.	Wait for at least 10 seconds, to see the very fast blink. Release the magnet once a very long orange LED appears

## 6 LED:

A yellow LED is used to indicate to the user a specific event:

		LED Behavior
Battery insertion		ON for 2s
Magnet event		ON for 200ms
Maintaining Magnet	<3s	Slow blinking
	[3s-10s]	Fast blinking
	>10s	OFF -> reboot

LED Location  
(Inside translucent cover)

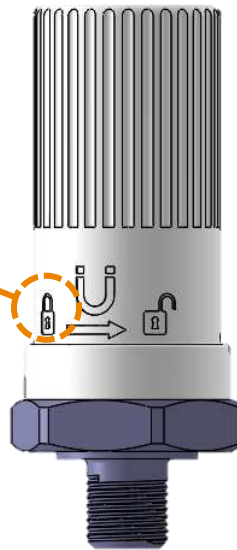

## 7 DIMENSIONS:

Dimensions units: Inches [Millimeter]

### COMPOUND TYPE CRITICAL DIMENSIONS

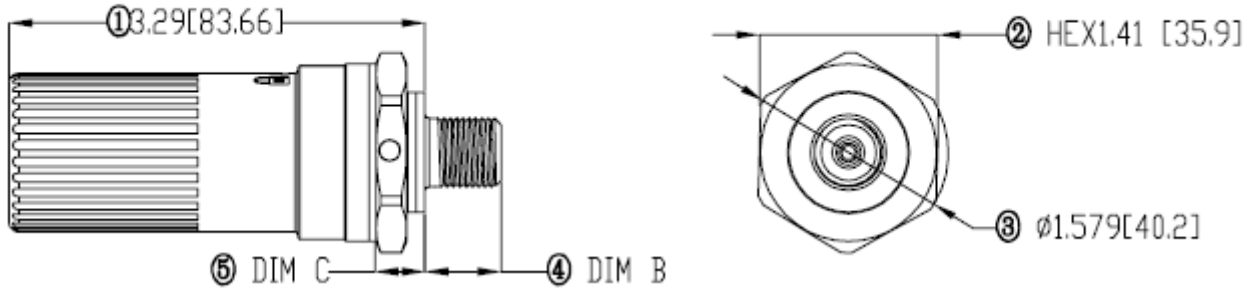

### ABSOLUTE TYPE CRITICAL DIMENSIONS

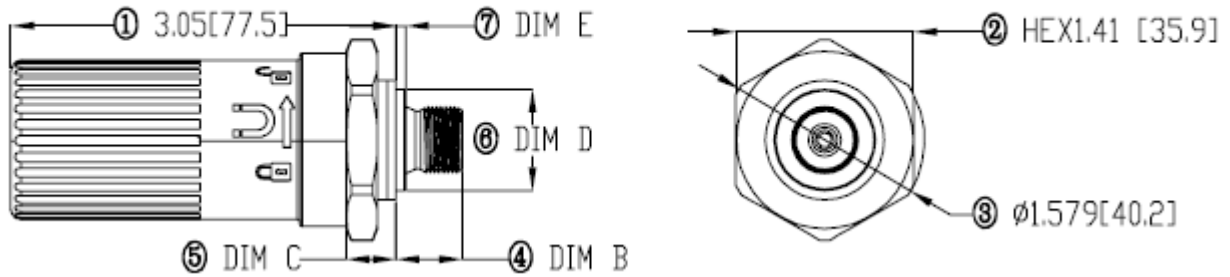

PORT TYPE	PRESSURE RANGE	DIM B TYP.	DIM D TYP.	DIM E TYP.
1/4-18 NPT	2 BAR	0.60 [15.24]	NA	NA
	7 BAR			
	20 BAR			
	35 BAR			
	200 BAR			
1/4-19 BSPP	2 BAR	0.526 [13.36]	0.80 [20.32]	0.075 [1.905]
	7 BAR			
	20 BAR			
	35 BAR			
	200 BAR			

Pressure Range	PRESSURE REF	DIM C TYP.
2, 7, 20, 35 BAR	ABSOLUTE	0.397 [10.08]
	COMPOUND	0.391 [9.92]
200, 350 BAR	ABSOLUTE COMPOUND	0.397 [10.08]



## 8 ORDERING INFORMATION:

### LoRa + BLE Sensor Model Number

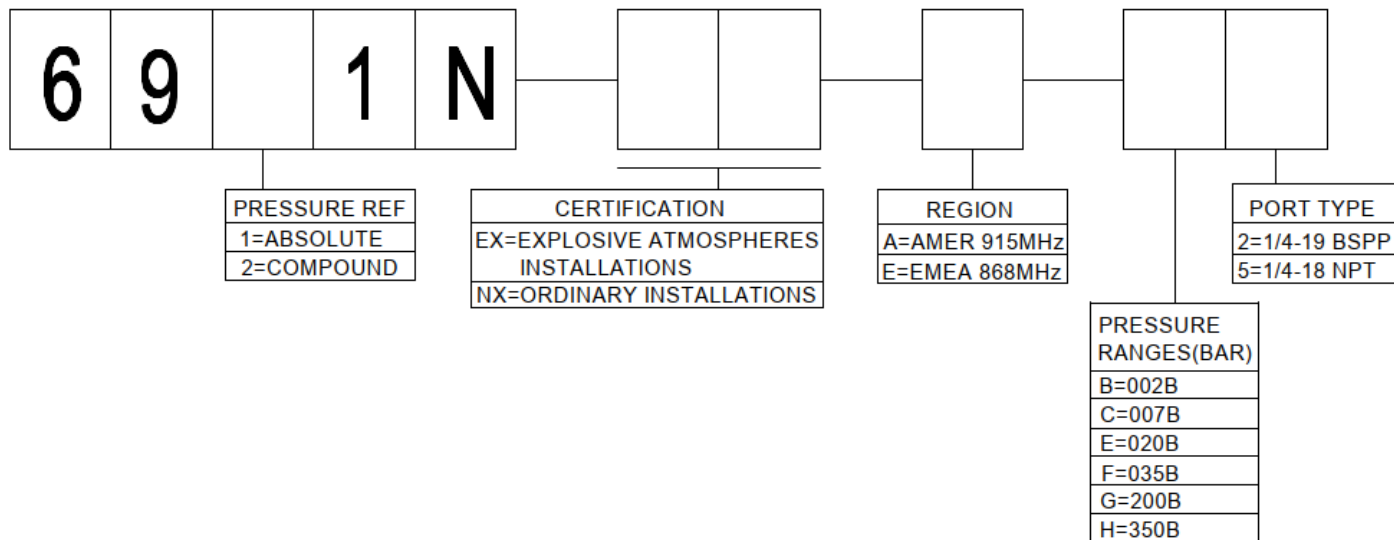

## 9 PART NUMBERING KEY:

The 69XXN is packaged in kits that contain a battery and a battery insertion tool. Use the TCPN number when ordering to ensure that you receive the proper kit.

Order TCPN	Sensor Model Number	Sensor Description	Battery (Saft 17330)	Battery Insert Tool
20023435-42	<b>6911N-EX-A-E5</b>	6911N-EX LoRa 915MHz US AB 20B NPT battery	•	•
20023435-43	<b>6911N-EX-A-F5</b>	6911N-EX LoRa 915MHz US AB 35B NPT battery	•	•
20023435-44	<b>6911N-EX-A-H5</b>	6911N-EX LoRa 915MHz US AB 350B NPT battery	•	•
20023435-45	<b>6911N-EX-A-C5</b>	6911N-EX LoRa 915MHz US AB 7B NPT battery	•	•
20023435-48	<b>6911N-NX-A-E5</b>	6911N-NX LoRa 915MHz US AB 20B NPT battery	•	•
20023435-49	<b>6911N-NX-A-F5</b>	6911N-NX LoRa 915MHz US AB 35B NPT battery	•	•
20023435-50	<b>6911N-EX-E-E2</b>	6911N-EX LoRa 868MHz EU AB 20B BSP battery	•	•
20023435-51*	<b>6911N-EX-E-H2</b>	6911N-EX LoRa 868MHz EU AB 350B BSP battery	•	•
20023435-52*	<b>6911N-EX-E-E5</b>	6911N-EX LoRa 868MHz EU AB 20B NPT battery	•	•
20023435-56	<b>6911N-NX-E-E2</b>	6911N-NX LoRa 868MHz EU AB 20B BSP battery	•	•
20023435-57	<b>6911N-EX-A-H2</b>	6911N-NX LoRa 868MHz EU AB 350B BSP battery	•	•
20029310-42	<b>6911N-NX-A-C5</b>	6911N-NX LoRa 915MHz US AB 7B NPT battery	•	•
20029310-50	<b>6911N-EX-E-H5</b>	6911N-EX LoRa 868MHz EU AB 350B NPT battery	•	•
20030511-40	<b>6911N-NX-A-H2</b>	6911N-NX LoRa 915MHz US AB 350B BSP battery	•	•

(\*) NCC certified sensor

# 69XXN WIRELESS PRESSURE SENSOR

## Revision History

Revision Number	Revision Date	Description	Pages Changed
1	19/01/2024	Initial release	-

[CLICK HERE >](#)  
**CONNECT WITH A SPECIALIST**

**NORTH AMERICA**  
Tel +1 800 522 6752

**EUROPE**  
Tel +31 73 624 6999

**ASIA**  
Tel +86 0400 820 6015

## [te.com/sensors](https://te.com/sensors)

TE Connectivity, TE, and TE connectivity (logo) are trademarks owned or licensed by the TE Connectivity Ltd. family of companies.

Apple, Google and Google Play are trademarks.

All other logos, products and/or company names referred to herein might be trademarks of their respective owners.

The information given herein, including drawings, illustrations and schematics which are intended for illustration purposes only, is believed to be reliable. However, TE Connectivity makes no warranties as to its accuracy or completeness and disclaims any liability in connection with its use. TE Connectivity's obligations shall only be as set forth in TE Connectivity's Standard Terms and Conditions of Sale for this product and in no case will TE Connectivity be liable for any incidental, indirect, or consequential damages arising out of the sale, resale, use or misuse of the product. Users of TE Connectivity products should make their own evaluation to determine the suitability of each such product for the specific application.

© 2024 TE Connectivity Corporation. All Rights Reserved

Published 01-2024



# Mouser Electronics

Authorized Distributor

Click to View Pricing, Inventory, Delivery & Lifecycle Information:

[TE Connectivity:](#)

[20023435-50](#) [6911N-NX-E-E2](#)