

Type 3560 Series

Key Features

6W@70°C in
4527 size
package

Suitable for
auto
placement

Available
from
distribution

Terminal
finish matte
sn over ni
barrier

AEC-Q200
Qualified



TE Connectivity is pleased to announce that our 3560 high power Thick Film Chip Resistor is now AEC-Q200 Qualified. This sister to our popular 3522 series is suitable for auto placement in volume and for most applications. Supplied as standard on 7 inch Reels of 1000 pieces per reel.

Characteristics – Electrical

Power Rating @ 70°C	6W
Resistance Range	1Ω ~ 10MΩ
Resistance Tolerance	±1%, ±5%
Temperature Coefficient of Resistance (TCR)	1Ω ≤ R ≤ 10Ω ± 400PPM/°C
	10Ω < R ≤ 100Ω ± 200PPM/°C
	100Ω < R ≤ 10MΩ ± 100PPM/°C
Max. Working Voltage	300V
Max. Overload Voltage	600V
Dielectric Withstanding Voltage	600V
Operating Temperature Range	-55°C ~ 155°C

Resistors shall have a rated direct-current (DC) continuous working voltage or an approximate sine-wave root-mean-square (RMS) alternating-current (AC) continuous working voltage at commercial line frequency and waveform corresponding to the power rating, as determined from the following formula :

$$RCWV = \sqrt{P \times R}$$

Where the calculated RCWV is greater than the stated Max. Working Voltage, the Max. Working Voltage will apply.

Power Rating and Derating

Resistors shall have a power rating based on continuous load operation at an ambient temperature of 70 °C . For temperature in excess of 70 °C , The load shall derate as shown in chart below.

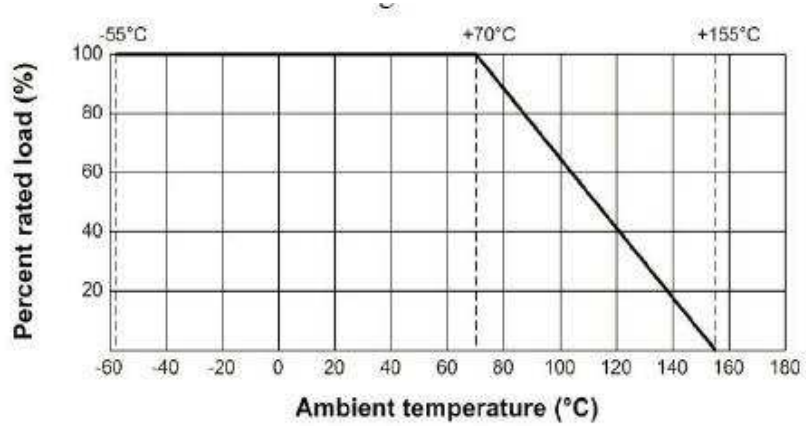

Construction and Dimensions:

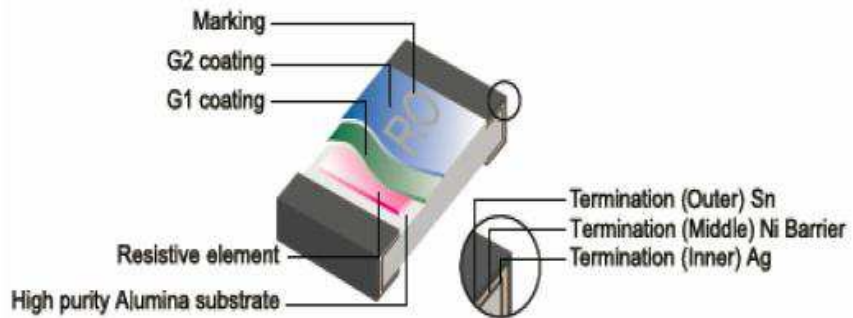

Type	Dimensions (mm)				
	L	W	H	ℓ1	ℓ2
3560	11.6 ± 0.30	6.85 ± 0.25	1.10 ± 0.10	1.00 ± 0.20	2.50 ± 0.20

Environmental Characteristics

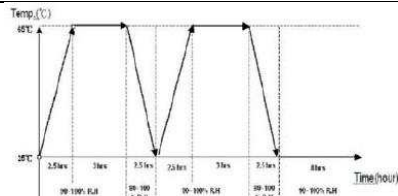
Characteristics	Limits	Test Methods
Operational Life	$\pm (1.0\% + 0.1\Omega)$ Max	125°C, at 35% of operating power, 1000H(1.5 hours "ON", 0.5 hour "OFF"). (MIL-STD-202)
	<100m Ω	Apply to rate current for 0 Ω
Electrical Characterization	$1\Omega \leq R \leq 10\Omega \leq \pm 400\text{PPM}/^\circ\text{C}$ $10\Omega < R \leq 100\Omega \leq \pm 200\text{PPM}/^\circ\text{C}$ $100\Omega < R \leq 10\text{M}\Omega \leq \pm 100\text{PPM}/^\circ\text{C}$	Parametrically test per lot and sample size requirements, summary to show Min, Max, Mean and standard deviation at room as well as Min and Max operating temperatures. (User spec)
External Visual	No Mechanical Damage	Electrical test not required. Inspect device construction, marking and workmanship (MIL-STD-883 Method 2009)
Physical Dimension	Reference Dimension Chart.	Verify physical dimensions to the applicable device detail specification. Note: User(s) and Suppliers spec. Electrical test not required (JESD22 MH Method JB-100)
Resistance To Solvent	Marking Unsmearred	Note: Add aqueous wash chemical-OKEM Clean or equivalent. Do not use banned solvents. (MIL-STD-202 Method 215)
Terminal Strength	Not Broken	Force of 1.8kg for 60 seconds. (JIS-C-6429)
High Temperature Exposure (storage)	$\pm (1.0\% + 0.1\Omega)$ Max	1000hrs. @T=155°C. Unpowered. Measurement at 24 \pm 2 hours after test conclusion. (MIL-STD-202 Method 108)
	<50m Ω	Apply to rate current for 0 Ω
Temperature Cycling	Resistance change rate is: $\pm (0.5\% + 0.1\Omega)$ Max.	1000 Cycles (-55°C to 155°C). Measure at 24 \pm hours after test conclusion. (JESD22 Method JA-104)
	<50m Ω	Apply to rate current for 0 Ω
Moisture Resistance	Resistance change rate is: $\pm (0.5\% + 0.1\Omega)$ Max.	 <p>T=24 hours / cycle. Unpowered. Measurement at 24\pm2 hours after test conclusion. (MIL-STD-202 Method 106)</p>
	<50m Ω	Apply to rate current for 0 Ω
Biased Humidity	Resistance change rate is: $\pm (1.0\% + 0.1\Omega)$ Max.	10% rated power, 85°C/85%RH, 1000H, Measurement at 24 hours after test conclusion. (MIL-STD-202 Method 103)
	<100m Ω	Apply to rate current for 0 Ω

Environmental Characteristics (cont.)

Characteristics	Limits	Test Methods
Mechanical Shock	$\pm (1.0\% + 0.1\Omega)$ Max.	Wave Form: Tolerance for half since shock pulse. Peak value is 100g's. Normal duration (D) is 6. (MIL-STD-202 Method 213)
Vibration	$\pm (1.0\% + 0.1\Omega)$ Max.	5g's for 20 min., 12 cycles each of 3 orientations. Note: Use 8"*5"PCB. 031" thick 7 secure points (on one) long side and 2 secure points at corners of opposite sides. Parts mounted within 2' from any secure point. Test from 10-2000Hz. (MIL-STD-202 Method 204)
Thermal Shock	$\pm (1.0\% + 0.1\Omega)$ Max.	-55°C to 155°C. Note: Number of cycles required -300, Maximum transfer time -20 seconds, Dwell time -15 minutes. Air-Air. (MIL-STD-202 Method 107)
	<50mΩ	Apply to rate current for 0Ω
ESD	$\pm (10.0\% + 0.1\Omega)$ Max.	With the electrometer in direct contact with the discharge tip, verify the voltage setting at levels of $\pm 500V$, $\pm 1KV$, $\pm 2KV$, $\pm 4KV$, $\pm 8KV$. The electrometer reading shall be within $\pm 10\%$ for voltage from 500V to $\leq 800V$. (AEC-Q200-002)
Solderability	95% Coverage Min.	For both leaded and SMD. Electrical test not required. Magnification 50X. Conditions: Method B 4hrs at 155°C dry heat, then dip in bath at 245°C, 5s. Method B: at 215°C, 5s. Method D: at 260°C, 60s. (J-STD-202)
Flammability	No ignition of the tissue paper or scorching of the pinewood board	V-0 or V-1 are acceptable. Electrical test not required. (UL-94)
Board Flex	$\pm (1.0\% + 0.05\Omega)$ Max.	2mm (Min) (JIS-C-6429)
	<50mΩ	Apply to rate current for 0Ω
Flame Retardance	No flame	Temperature sensing at 500°C, Voltage power subjected to 32VDC current clamped up to 500ADC and decreased in 1.0VDC/hour. (AEC-Q200-001)
Resistance To Soldering Heat	$\pm (1.0\% + 0.05\Omega)$ Max.	Condition B No per-heat of samples. Note: Single Wave Solder-Procedure 2 for SMD and Procedure 1 for Leaded with solder within 1.5mm of device body. (MIL-STD-202 Method 210)
	<50mΩ	Apply to rate current for 0W

* Sulfuration test: H2S 3~5PPM 50 ± 2 91%~93%RH 1000H

Marking

A. 4 digit marking for E-96 series:

*The first 3 digits are significant figures of resistance and the 4th digit denoted number of zeros.

Ex.

	1273	
--	-------------	--

 127K Ω

*For ohmic values below 100 Ω , letter "R" is for decimal point.

Ex.

	49R9	
--	-------------	--

 49.9 Ω

B. 3 digit marking for E-24 series:

*The first 2 digits are significant figures of resistance and the 3rd digit denoted number of zeros

Ex.

	124	
--	------------	--

 120K Ω

*For ohmic values below 10 Ω , letter "R" is for decimal point

Ex.

	4R7	
--	------------	--

 4.7 Ω

Soldering

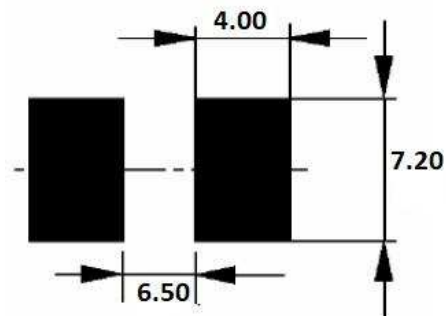

4 layers PCB specification:

- 1) Outside 2 layers (Top and Bottom) with copper foil thickness at 2oz.
- 2) Inside 2 layers (Middle layers) with copper foil thickness at 4 oz.

Soldering (cont.)

Reflow solder profile

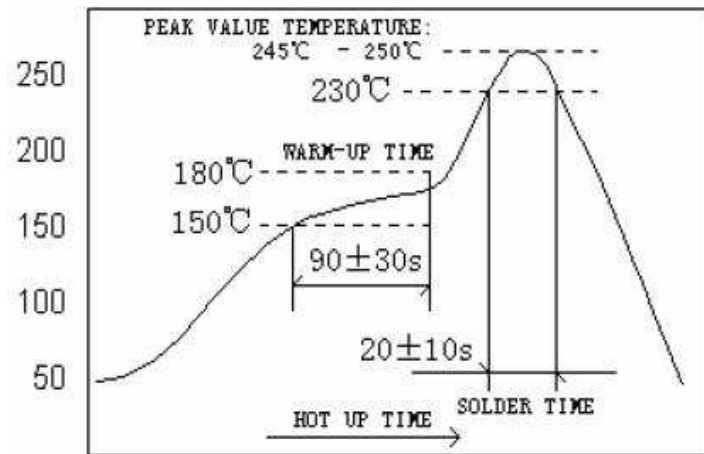

Packaging

Tape and Reel

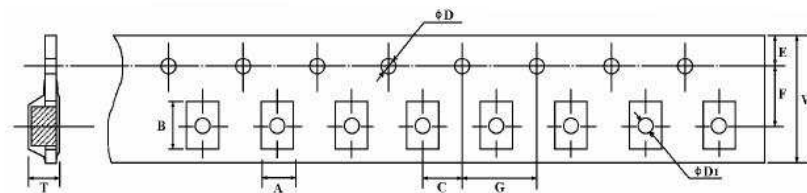

A ±0.1	B ±0.1	C ±0.15	∅D+0.1 -0	E±0.1	F±0.15	G ±0.1	W ±0.3	∅D1 ±0.1	T ± 0.1
7.20	11.9	2.0	1.5	1.75	11.5	4.0	24	-	1.35

Peeling Strength of Top Cover Tape

Test Condition: 0.1 to 0.7 N at a peel-off speed of 300 mm / min.

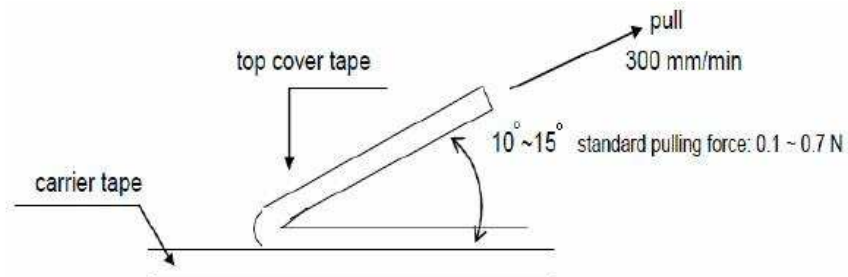

Reel Dimensions

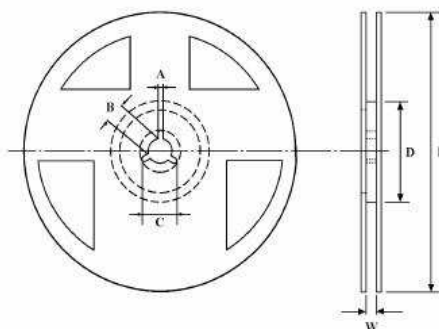

Qty Reel	A±0.5	B±0.5	C±0.5	D±1	M±2	W±1
1000	2.0	13.0	21	60.0	178	25.5

Environment Related Substance

This product complies to EU RoHS directive, EU PAHs directive, EU PFOS directive and Halogen free.

Ozone depleting substances are not used in our manufacturing process of this product. This product is not manufactured using Chloro fluorocarbons (CFCs), Hydrochlorofluorocarbons (HCFCs), Hydrobromofluorocarbons (HBFCs) or other ozone depleting substances in any phase of the manufacturing process.

Storage Condition

The performance of these products, including the solderability, is guaranteed for a year from the date of arrival at your company, provided that they remain packed as they were when delivered and stored at a temperature of $25^{\circ}\text{C} \pm 10^{\circ}\text{C}$ and a relative humidity of $60\%\text{RH} \pm 10\%\text{RH}$, chemical and dust free atmosphere.

Even within the above guarantee periods, do not store these products in the following conditions:

1. In salty air or in air with a high concentration of corrosive gas, such as Cl_2 , H_2S , NH_3 , SO_2 , or NO_2
2. In direct sunlight

How To Order

3540	1R0	F	T
Common Part	Resistance Value	Tolerance	Pack Style
3560 – 6W 4527 Resistor	1 Ω - 1R0 100 Ω - 100R 1K Ω - 1K0	F – 1% J – 5%	T- 1000 per reel

While TE has made every reasonable effort to ensure the accuracy of the information in this Data Sheet, TE does not guarantee that it is error-free, nor does TE make any other representation, warranty or guarantee that the information is accurate, correct, reliable or current. TE reserves the right to make any adjustments to the information contained herein at any time without notice. TE expressly disclaims all implied warranties regarding the information contained herein, including, but not limited to, any implied warranties of merchantability or fitness for a particular purpose. The dimensions in this data sheet are for reference purposes only and are subject to change without notice. Specifications are subject to change without notice. Consult TE for the latest dimensions and design specifications.

Mouser Electronics

Authorized Distributor

Click to View Pricing, Inventory, Delivery & Lifecycle Information:

[TE Connectivity:](#)

[35602K7JT](#)