

P	LTR	DESCRIPTION	DATE	DWN	APVD
A		INITIAL	31MAY2022	F.Z	R.B
B			16APR2024	R.W	R.B

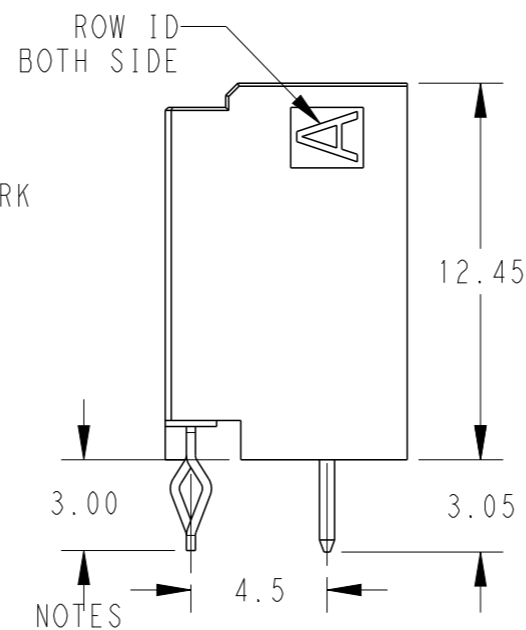

- NOTES
- MATERIAL: HOUSING: GLASS FILLED THERMO PLASTIC POLYSTER(UL94V-0), COLOR: BLACK
CONTACT: COPPER ALLOY
RETENTION LEG: PRE-TIN COPPER ALLOY
 - FINISH (ALL OVER): NICKEL PLATING 1.27umMIN.
 - FINISH (CONTACT TAB): GOLD PLATING: 0.38umMIN.
(CONTACT TAIL): TIN PLATING: 1.0umMIN.
 - THE KEYING ARRANGEMENT OF "Y" IS SYMMETIC WITH "X"
 - THE SHAPE, SIZE AND POSITION OF THE CHARACTER SHOWN THE OUTLINE, AND DON'T SHOWN DETAIL

16	Y	15	30.0	33.0	34.6	2-2394617-3
16	X	15	30.0	33.0	34.6	1-2394617-3
10	Y	9	18.0	21.0	22.6	2-2394617-0
10	X	9	18.0	21.0	22.6	1-2394617-0
8	Y	7	14.0	17.0	18.6	2-2394617-8
8	X	7	14.0	17.0	18.6	1-2394617-8
4	Y	3	6.0	9.0	10.6	2-2394617-4
4	X	3	6.0	9.0	10.6	1-2394617-4
POS	KEY	n	A	B	C	PART NO

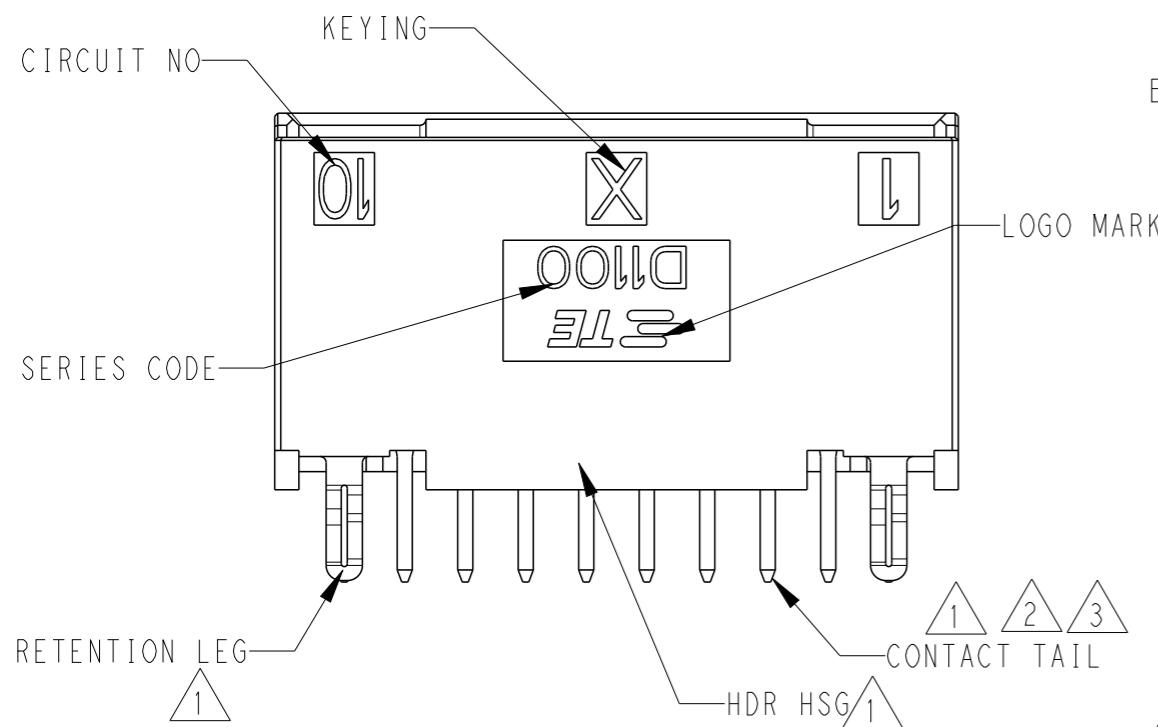
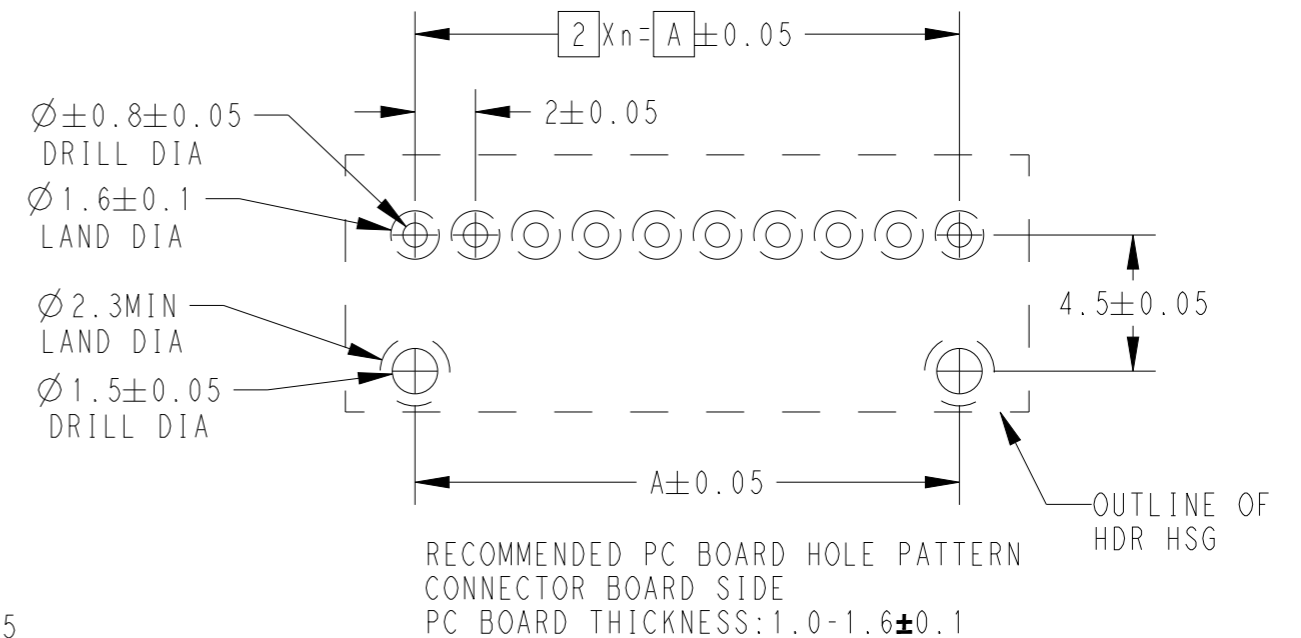
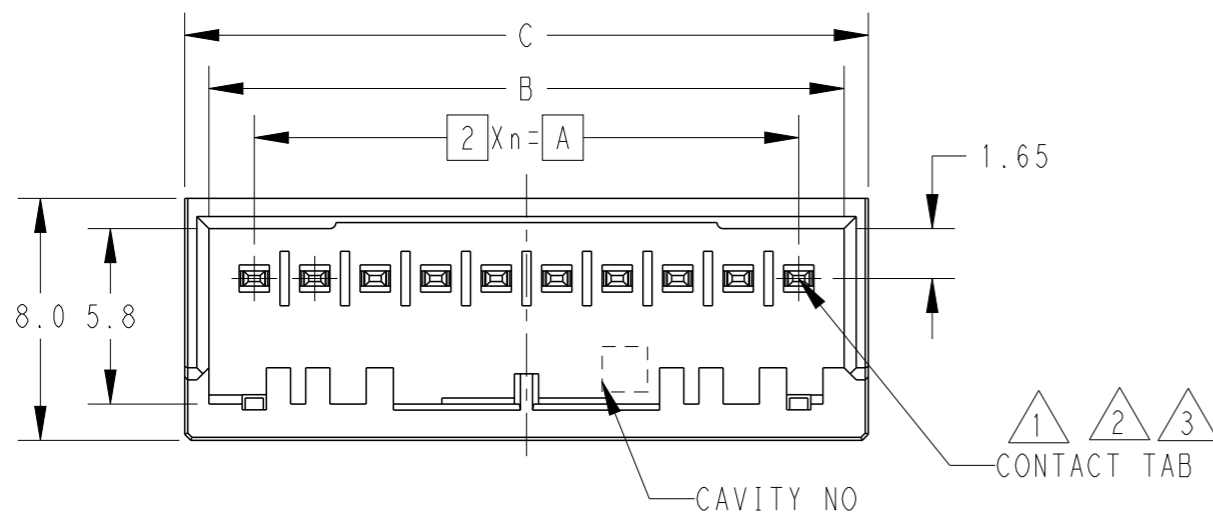
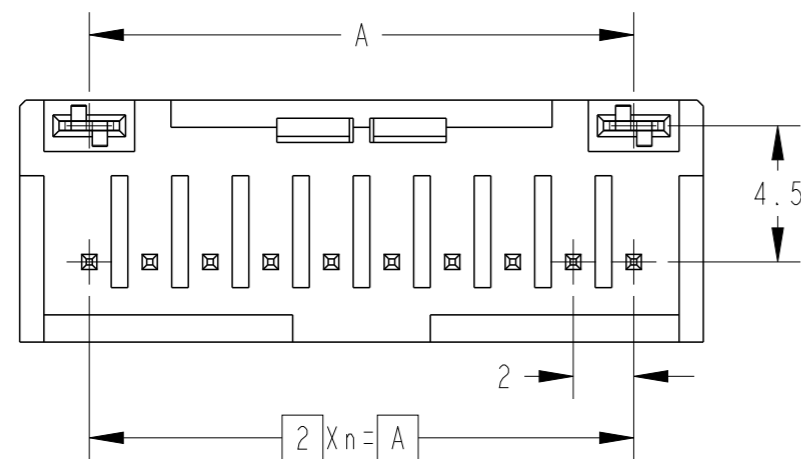

10POS PN: 1-2394617-0

THIS DRAWING IS A CONTROLLED DOCUMENT.

DWN	31MAY2022	 TE Connectivity	NAME DYNAMIC D1100 SERIES HDR ASSY, 4-10POS, V-TYPE, AU-PL							
CHK	31MAY2022									
APVD	31MAY2022									
PRODUCT SPEC	108-78268									
APPLICATION SPEC	114-5377	SIZE	A3	CAGE CODE	00779	DRAWING NO	C-2394617	RESTRICTED TO	-	
MATERIAL	FINISH	WEIGHT	CUSTOMER DRAWING		SCALE	2:1	SHEET	1 OF 3	REV	B

REVISIONS

P	LTR	DESCRIPTION	DATE	DWN	APVD

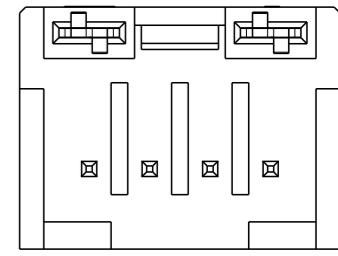
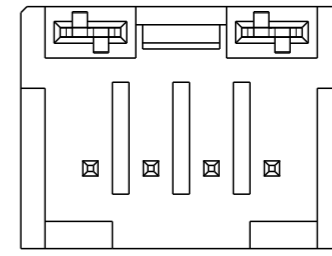
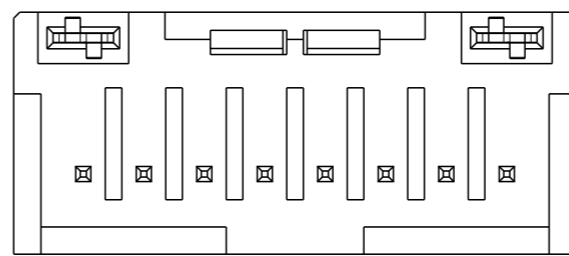
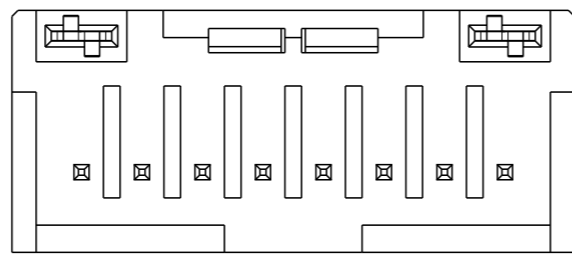
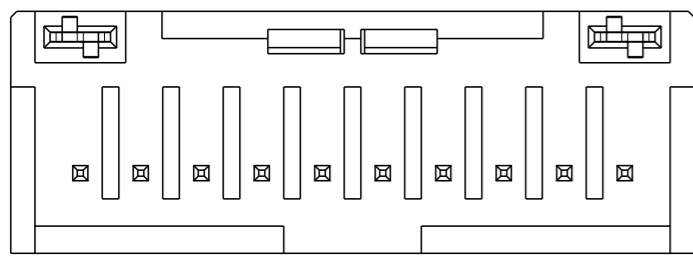
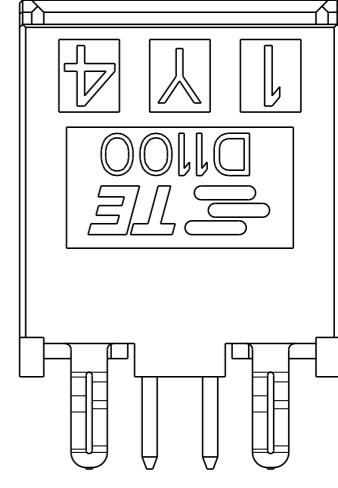
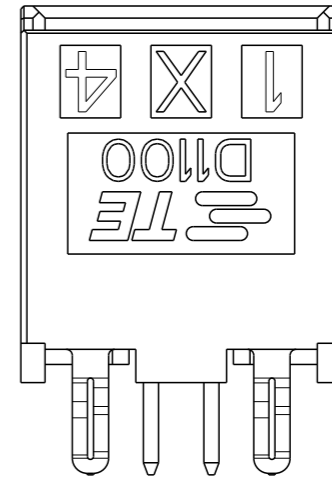
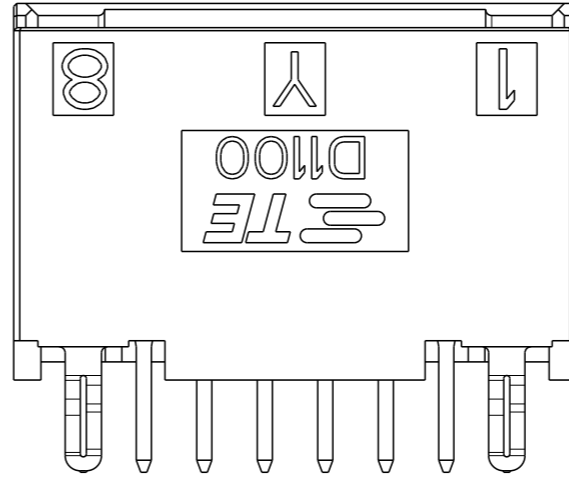
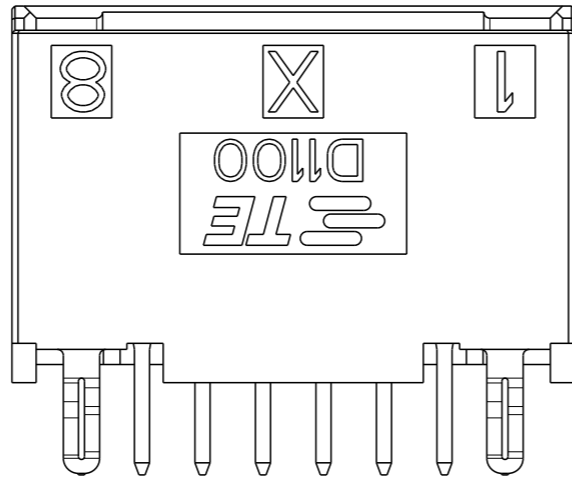
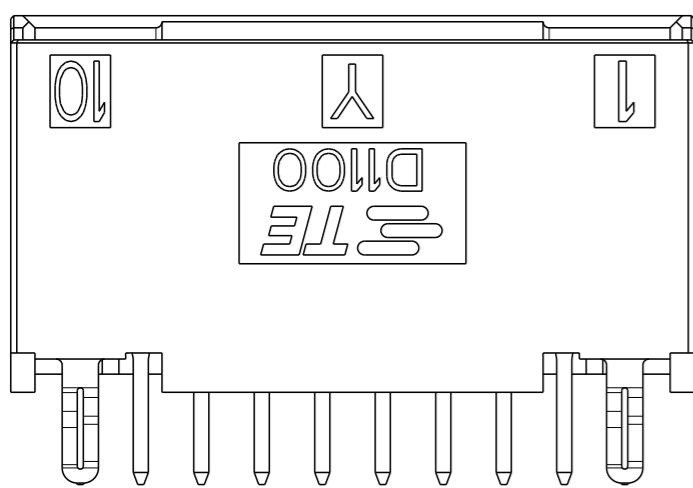
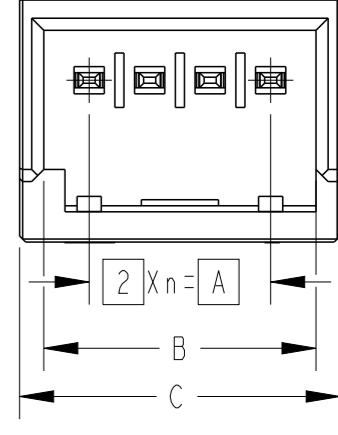
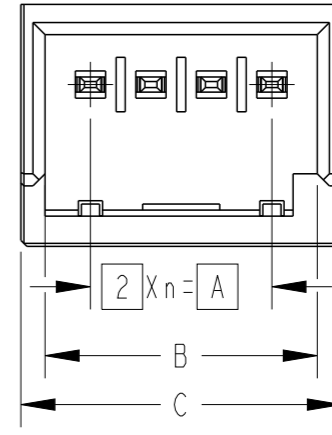
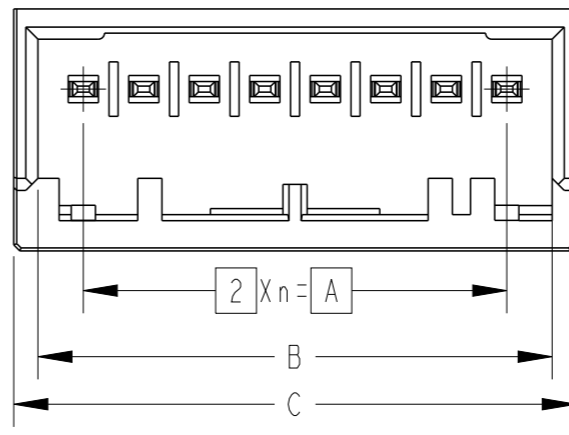
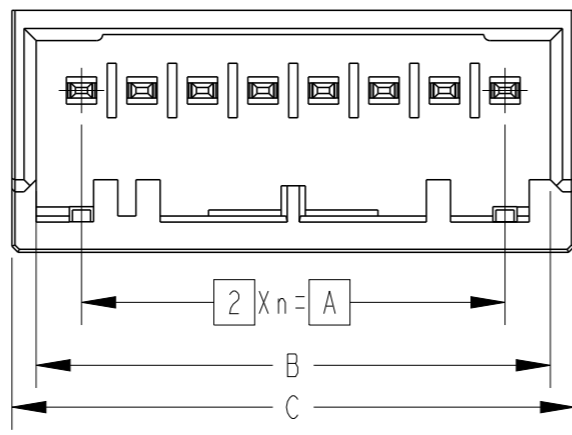
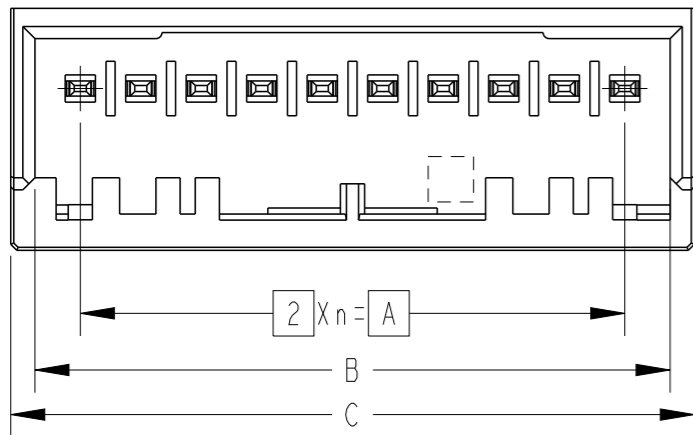

THIS DRAWING IS A CONTROLLED DOCUMENT.

DIMENSIONS:
mm

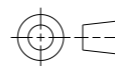

TOLERANCES UNLESS OTHERWISE SPECIFIED:

- 0 PLC ±0.3
- 1 PLC ±0.3
- 2 PLC ±0.3
- 3 PLC ±0.3
- 4 PLC ±0.3
- ANGLES ±3°

MATERIAL

FINISH

DWN 31MAY2022

FISHER ZHU

CHK 31MAY2022

RICK BIAN

APVD 31MAY2022

RICK BIAN

PRODUCT SPEC

SEE SHEET 1/2

APPLICATION SPEC

SEE SHEET 1/2

WEIGHT

CUSTOMER DRAWING



TE Connectivity

NAME
DYNAMIC D1100 SERIES
HDR ASSY, 4-10POS, V-TYPE, AU-PL

SIZE	CAGE CODE	DRAWING NO	RESTRICTED TO
------	-----------	------------	---------------

A3	00779	C-2394617	-
----	-------	-----------	---

SCALE	SHEET	OF	REV
4:1	2	3	B

P	LTR	DESCRIPTION	DATE	DWN	APVD

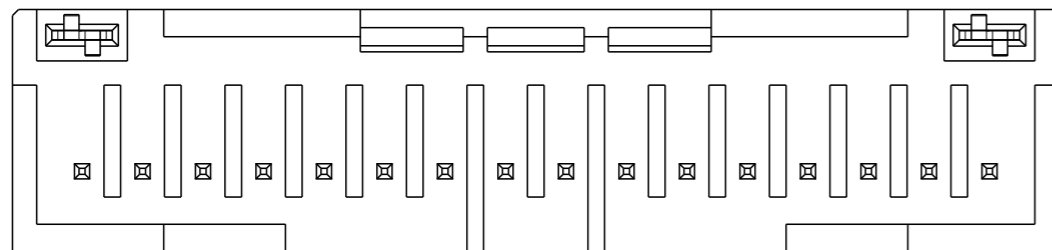
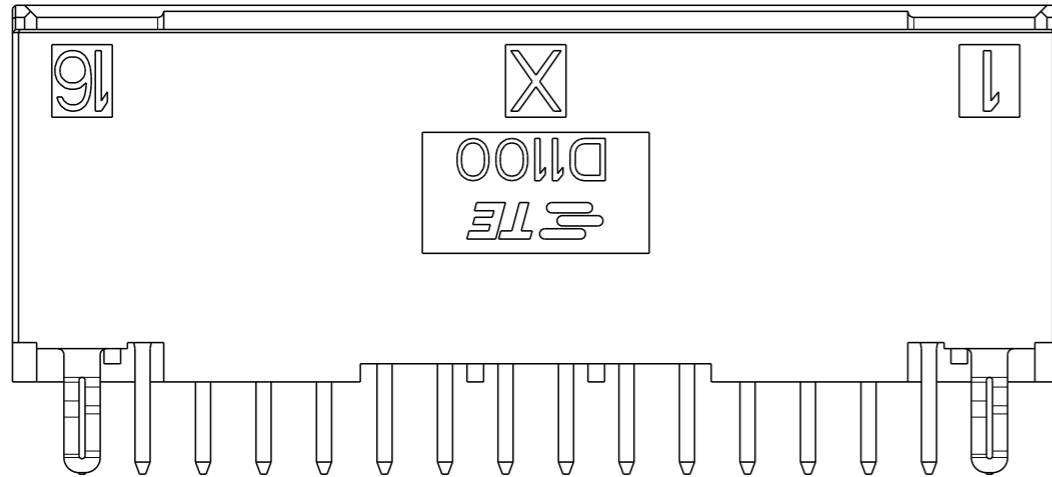
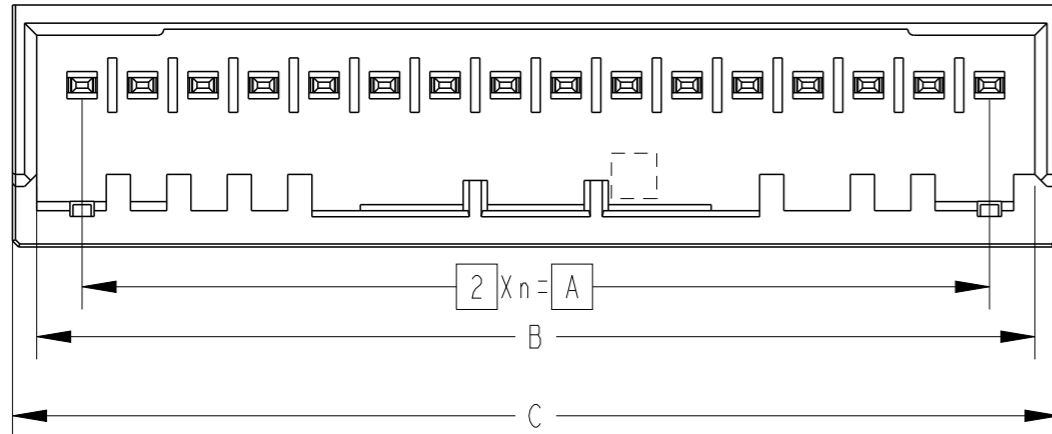

THIS DRAWING IS A CONTROLLED DOCUMENT.

DIMENSIONS:	TOLERANCES UNLESS OTHERWISE SPECIFIED:
mm	
	0 PLC ±0.3
	1 PLC ±0.3
	2 PLC ±0.3
	3 PLC ±0.3
	4 PLC ±0.3
	ANGLES ±3°

MATERIAL FINISH

DWN	31MAY2022
FISHER ZHU	
CHK	31MAY2022
RICK BIAN	
APVD	31MAY2022
RICK BIAN	
PRODUCT SPEC	SEE SHEET1/2
APPLICATION SPEC	SEE SHEET1/2
WEIGHT	

TE Connectivity			
NAME DYNAMIC D1100 SERIES HDR ASSY, 4-10POS, V-TYPE, AU-PL			
SIZE	CAGE CODE	DRAWING NO	RESTRICTED TO
A3	00779	C-2394617	-

CUSTOMER DRAWING SCALE 2:1 SHEET 3 OF 3 REV B

Mouser Electronics

Authorized Distributor

Click to View Pricing, Inventory, Delivery & Lifecycle Information:

[TE Connectivity:](#)

[2-2394617-4](#) [1-2394617-4](#)