

P	LTR	DESCRIPTION	DATE	DWN	APVD
A		INITIAL	30MAY2022	F.Z	R.B
B		REVISED PER ECR-22-162100	23DEC2022	C.C	R.B
C		REVISED PER ECR-23-170031	22MAR2023	C.C	R.B
D		Obsolete 2-2390471-1	29APR2024	R.W	R.B

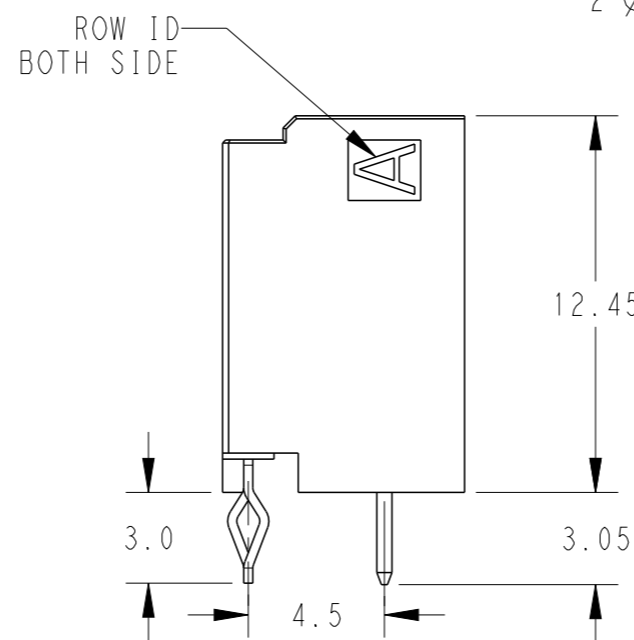
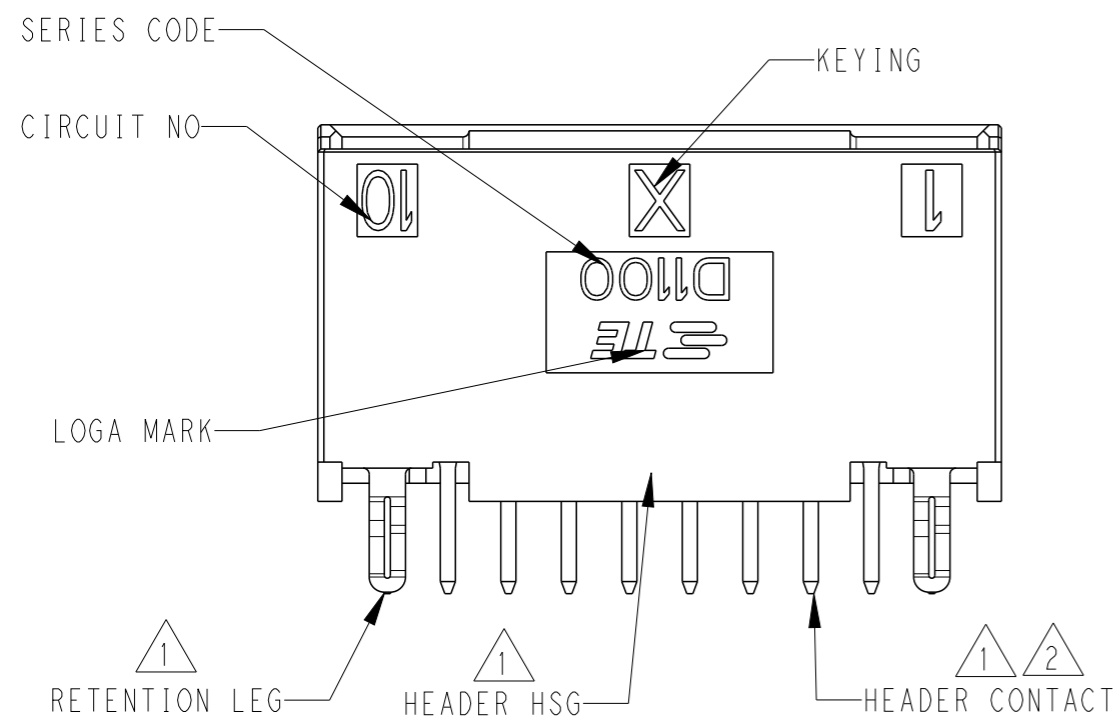
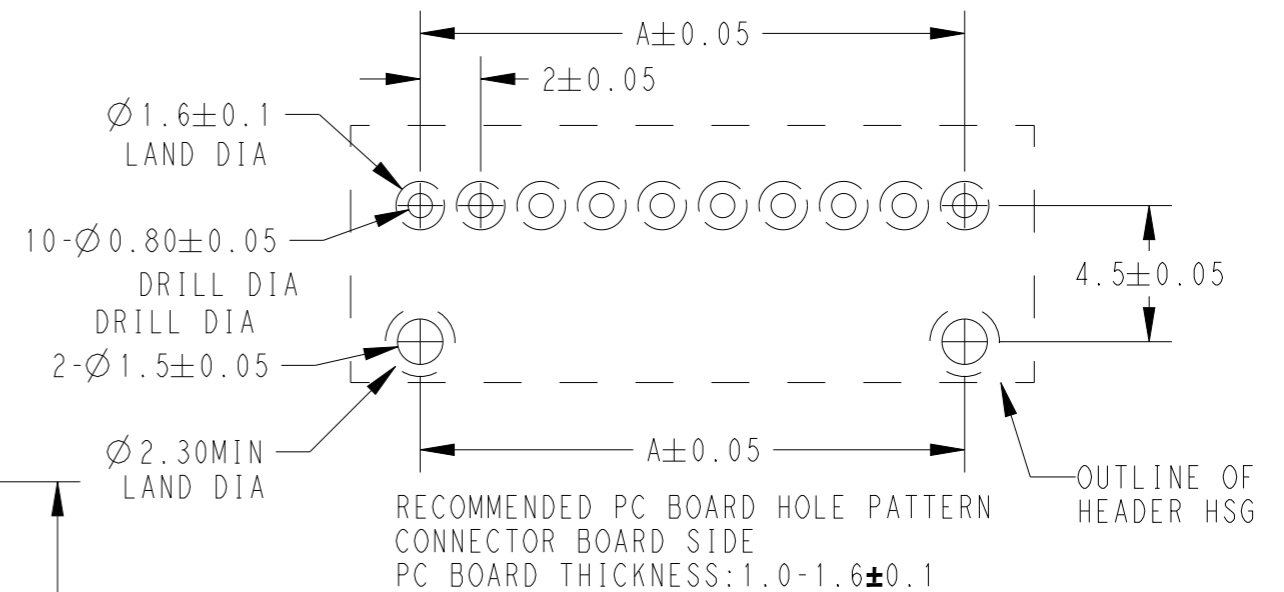
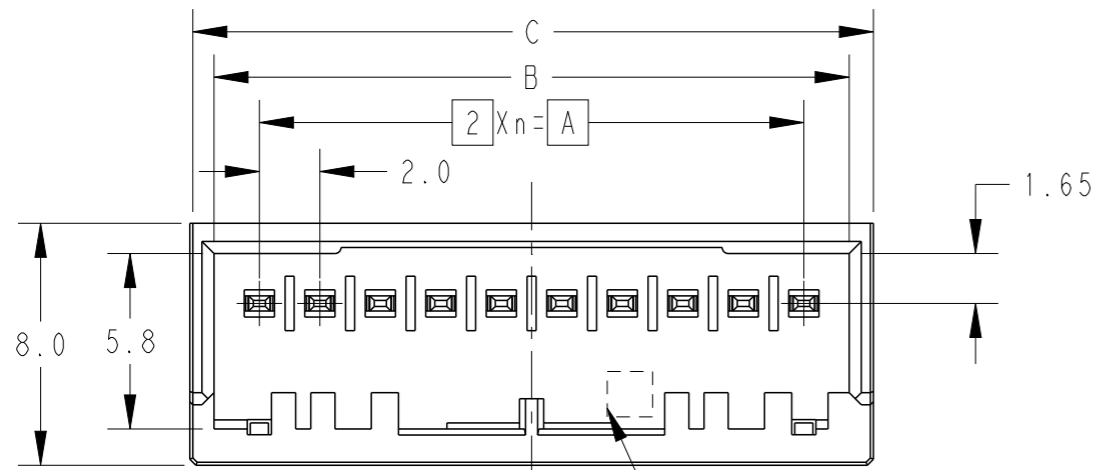

NOTES

- 1 MATERIAL: HOUSING: GLASS FILLED THERMO PLASTIC POLYESTER(UL94V-0), COLOR: BLACK  
CONTACT: COPPER ALLOY  
RETENTION LEG: PRE-TIN COPPER ALLOY
- 2 FINISH (ALL OVER): TIN PLATING: 1.0umMIN  
AFTER NICKEL PLATING WITH 1.27umMIN
- 3. THE KEYING ARRANGEMENT OF "Y" IS SYMMETIC WITH "X"
- 4. THE SHAPE, SIZE AND POSITION OF THE CHARACTER SHOWN THE OUTLINE, AND DON'T SHOWN DETAIL

16	Y	15	30.0	33.0	34.6	2-2390471-3
16	X	15	30.0	33.0	34.6	1-2390471-3
14	Y	13	26.0	29.0	30.6	2-2390471-2
14	X	13	26.0	29.0	30.6	1-2390471-2
12	Y	11	22.0	25.0	26.6	2-2390471-1
12	X	11	22.0	25.0	26.6	1-2390471-1
10	Y	9	18.0	21.0	22.6	2-2390471-0
10	X	9	18.0	21.0	22.6	1-2390471-0
8	Y	7	14.0	17.0	18.6	2-2390471-8
8	X	7	14.0	17.0	18.6	1-2390471-8
4	Y	3	6.0	9.0	10.6	2-2390471-4
4	X	3	6.0	9.0	10.6	1-2390471-4
POS	KEY	n	A	B	C	PART NO

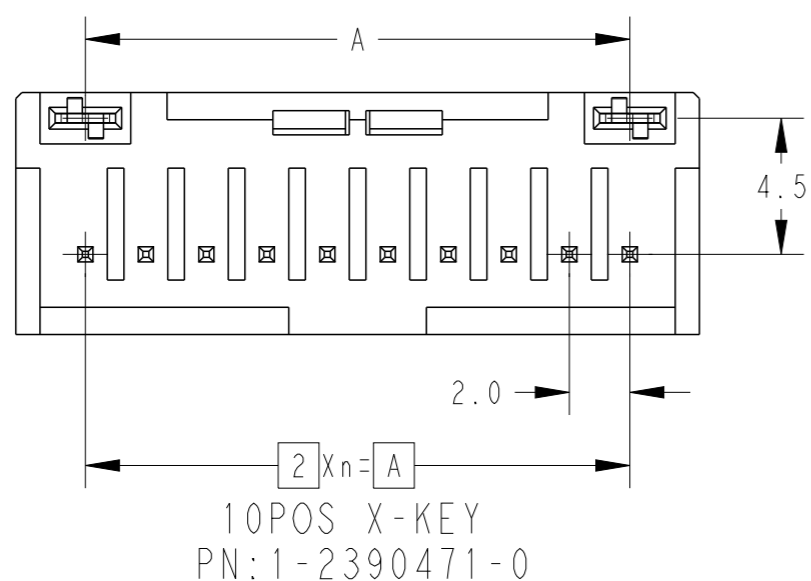

THIS DRAWING IS A CONTROLLED DOCUMENT.

DIMENSIONS:	TOLERANCES UNLESS OTHERWISE SPECIFIED:
mm	
	±0.2
	±0.2
	±0.2
	±0.2
	±0.2
	±3°
MATERIAL	FINISH
1	2

DWN	30MAY2022
FISHER ZHU	
CHK	30MAY2022
RICK BIAN	
APVD	30MAY2022
RICK BIAN	
PRODUCT SPEC	108-78298
APPLICATION SPEC	114-5377
WEIGHT	
CUSTOMER DRAWING	

TE Connectivity		NAME	
		DYNAMIC D1100S SERIES HDR ASSY, V-TYPE, 4-16POS, TIN	
SIZE	CAGE CODE	DRAWING NO	RESTRICTED TO
A3	00779	C-2390471	-
SCALE		SHEET	REV
4:1		1 OF 3	D

REVISIONS

P	LTR	DESCRIPTION	DATE	DWN	APVD
		SEE SHEET 1			

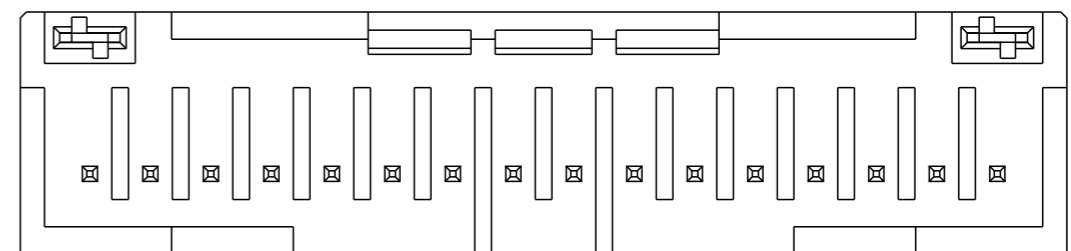
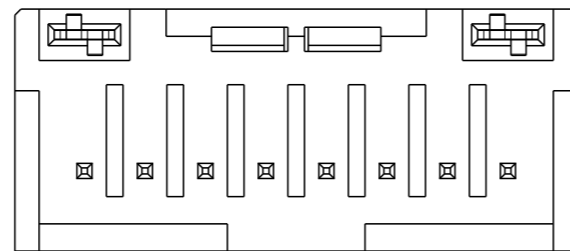
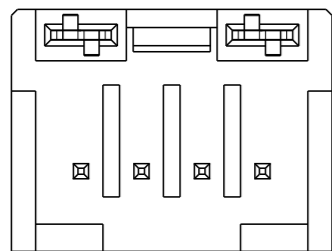
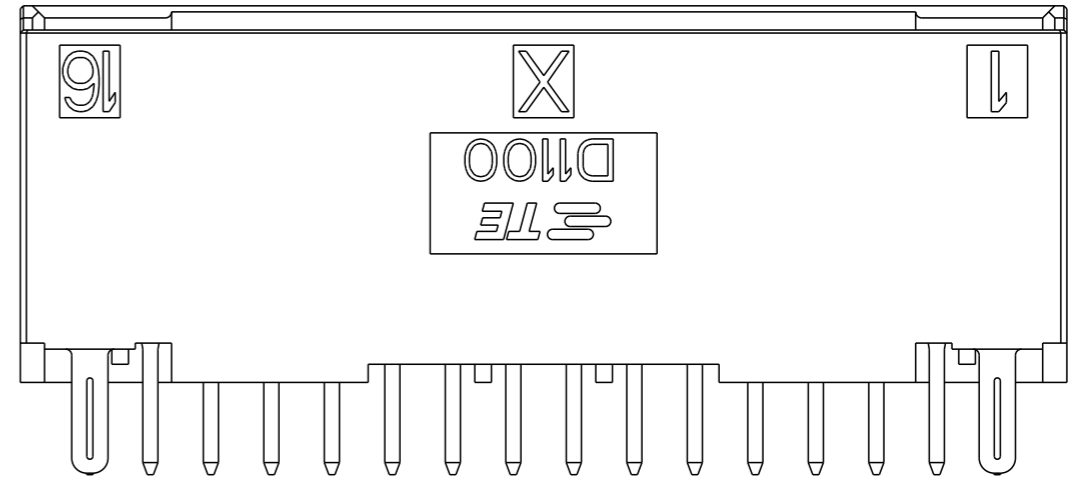
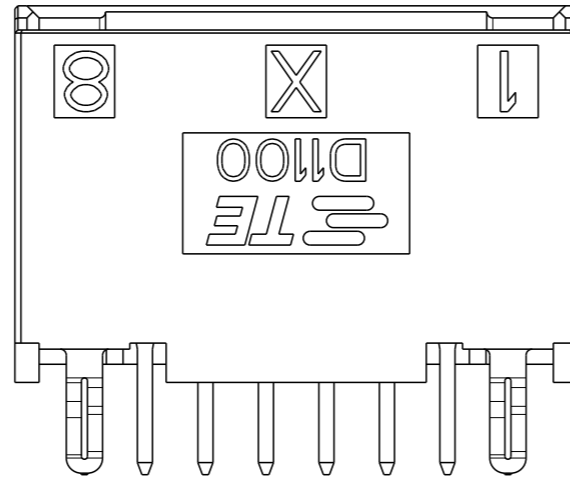
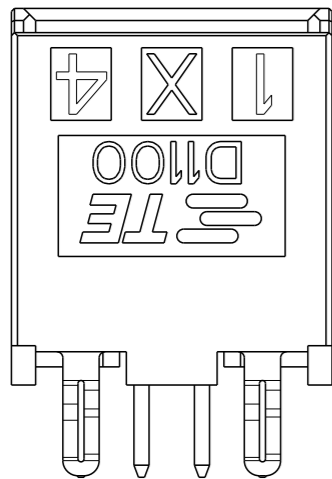
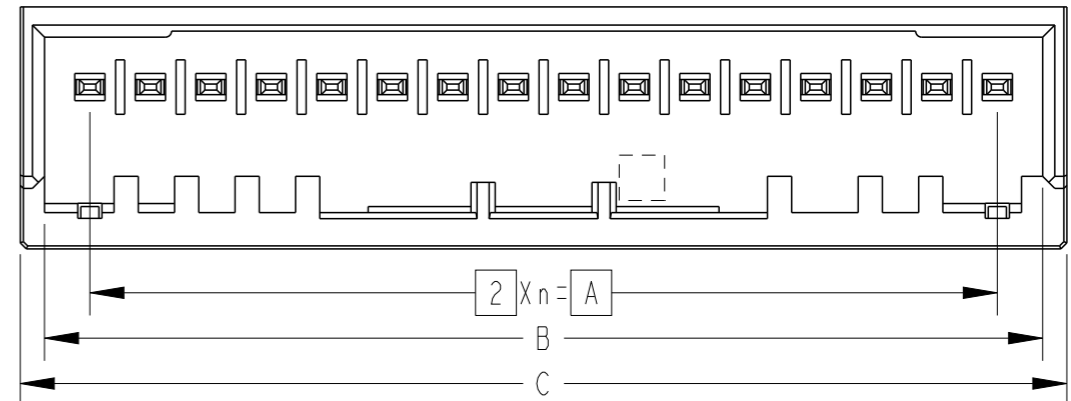
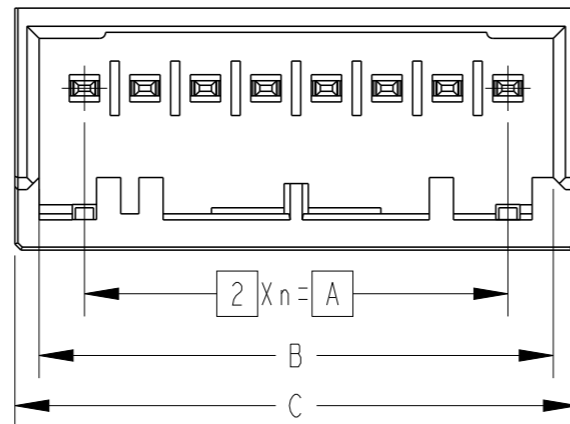
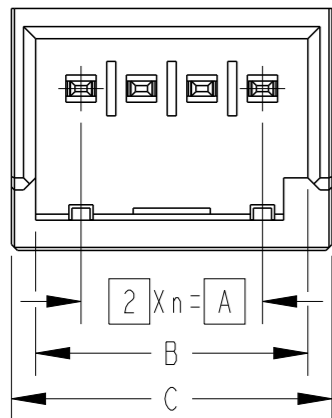

4POS X-KEY  
PN: 1-2390471-4

8POS X-KEY  
PN: 1-2390471-8

16POS X-KEY  
PN: 1-2390471-3

THIS DRAWING IS A CONTROLLED DOCUMENT.

DIMENSIONS: mm	TOLERANCES UNLESS OTHERWISE SPECIFIED: 0 PLC ±0.2 1 PLC ±0.2 2 PLC ±0.2 3 PLC ±0.2 4 PLC ±0.2 ANGLES ±3°
MATERIAL SEE SEET1/3	FINISH SEE SEET1/3

DWN FISHER ZHU 30MAY2022	 TE Connectivity
CHK RICK BIAN 30MAY2022	
APVD RICK BIAN 30MAY2022	
PRODUCT SPEC SEE SEET1/3	
APPLICATION SPEC SEE SEET1/3	NAME DYNAMIC D1100S SERIES HDR ASSY, V-TYPE, 4-16POS, TIN
WEIGHT	SIZE A3
CUSTOMER DRAWING	CAGE CODE 00779
	DRAWING NO C-2390471
	RESTRICTED TO -
	SCALE 4:1
	SHEET 2 OF 3
	REV D

REVISIONS

P	LTR	DESCRIPTION	DATE	DWN	APVD
		SEE SHEET 1			

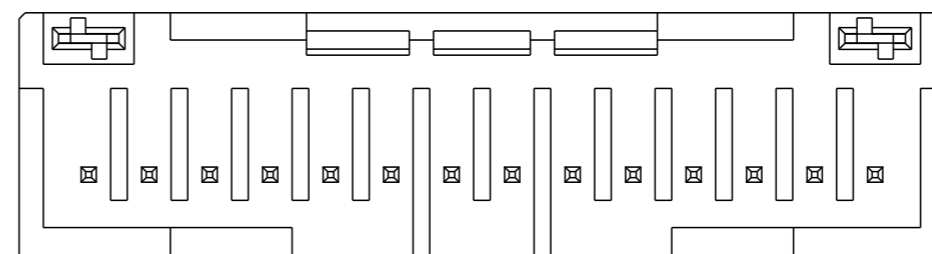
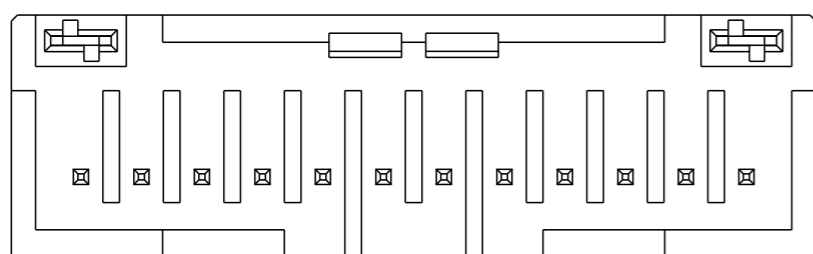
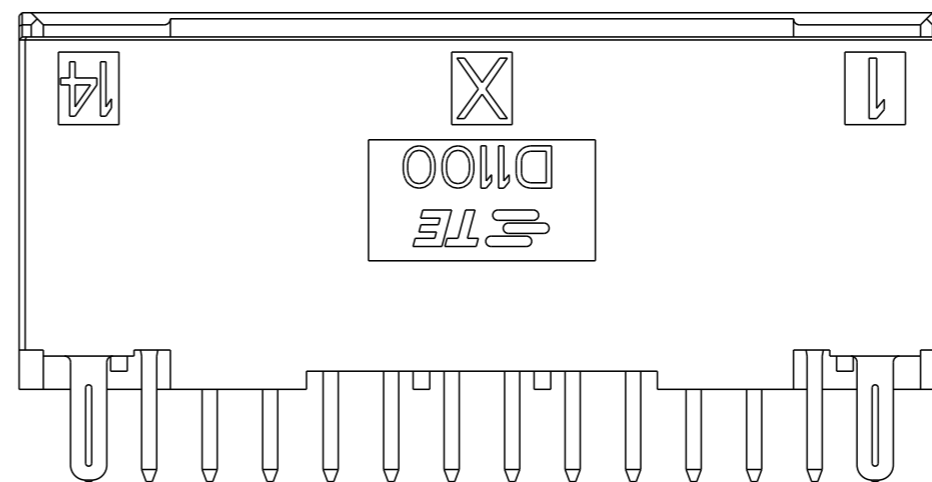
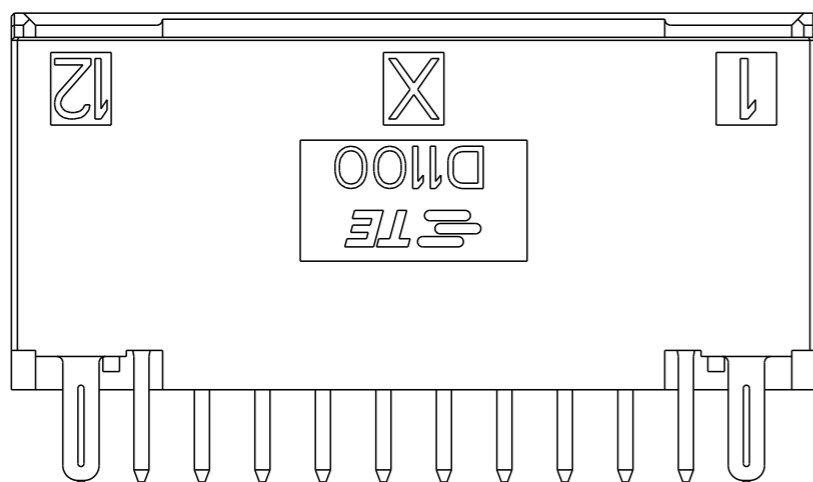
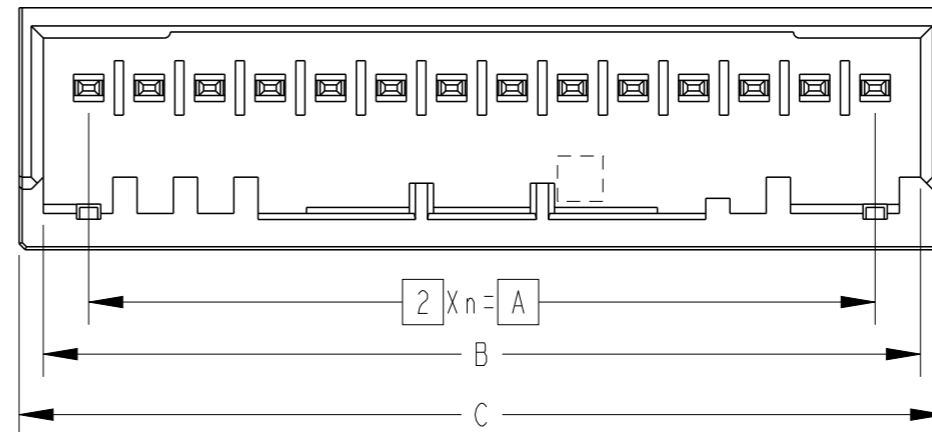
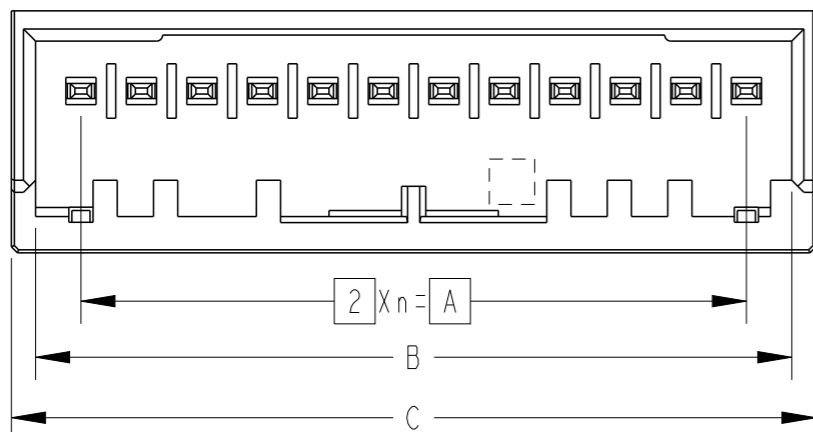

12POS X-KEY  
PN: 1-2390471-1

14POS X-KEY  
PN: 1-2390471-2

THIS DRAWING IS A CONTROLLED DOCUMENT.		DWN FISHER ZHU 30MAY2022	 TE Connectivity	
DIMENSIONS: mm		CHK RICK BIAN 30MAY2022		
TOLERANCES UNLESS OTHERWISE SPECIFIED:		APVD RICK BIAN 30MAY2022	NAME DYNAMIC D1100S SERIES HDR ASSY, V-TYPE, 4-16POS, TIN	
0 PLC ± 0.2		PRODUCT SPEC SEE SEET1/3	SIZE A3	
1 PLC ± 0.2		APPLICATION SPEC SEE SEET1/3	CAGE CODE 00779	DRAWING NO G-2390471
2 PLC ± 0.2		WEIGHT	RESTRICTED TO -	
3 PLC ± 0.2		CUSTOMER DRAWING	SCALE 4:1	SHEET 3 OF 3
4 PLC ± 0.2				REV D
ANGLES ± 3°				
FINISH SEE SEET1/3				
MATERIAL SEE SEET1/3				

# Mouser Electronics

Authorized Distributor

Click to View Pricing, Inventory, Delivery & Lifecycle Information:

[TE Connectivity:](#)

[1-2390471-1](#)