

P	LTR	DESCRIPTION	DATE	DWN	APVD
A		RELEASED PER ECN-22-173278	13SEP2022	N.H	L.C
A1		REVISED PER ECR-24-198337	29JAN2024	N.H	L.C

KEYING A SHOWN FOR 5 POSITION

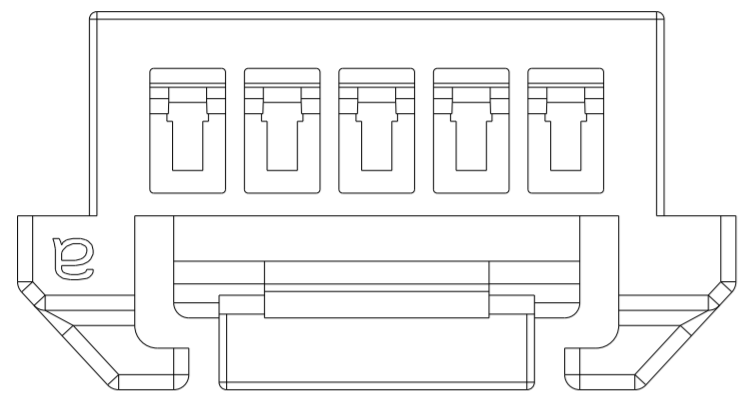

KEYING B SHOWN FOR 5 POSITION

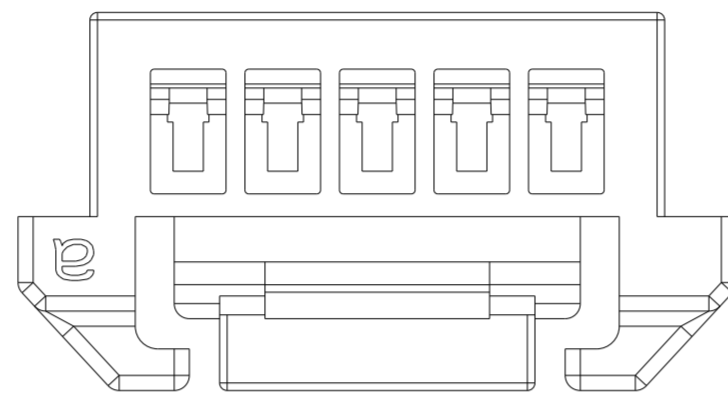

KEYING C SHOWN FOR 5 POSITION

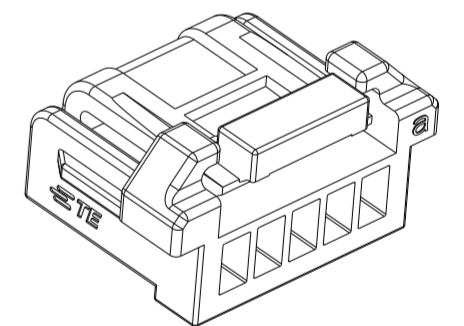
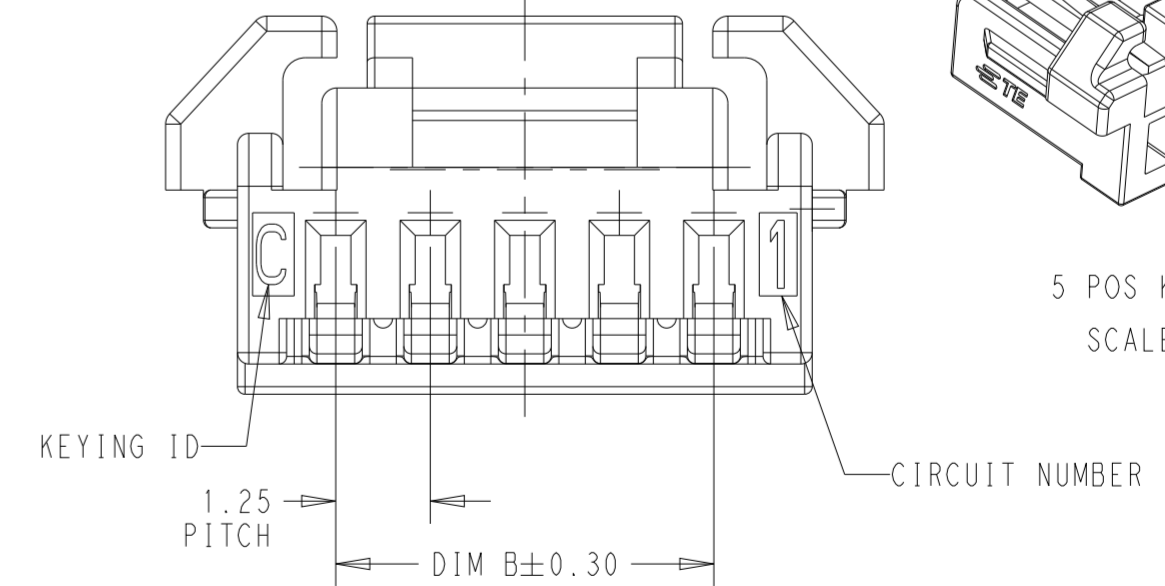
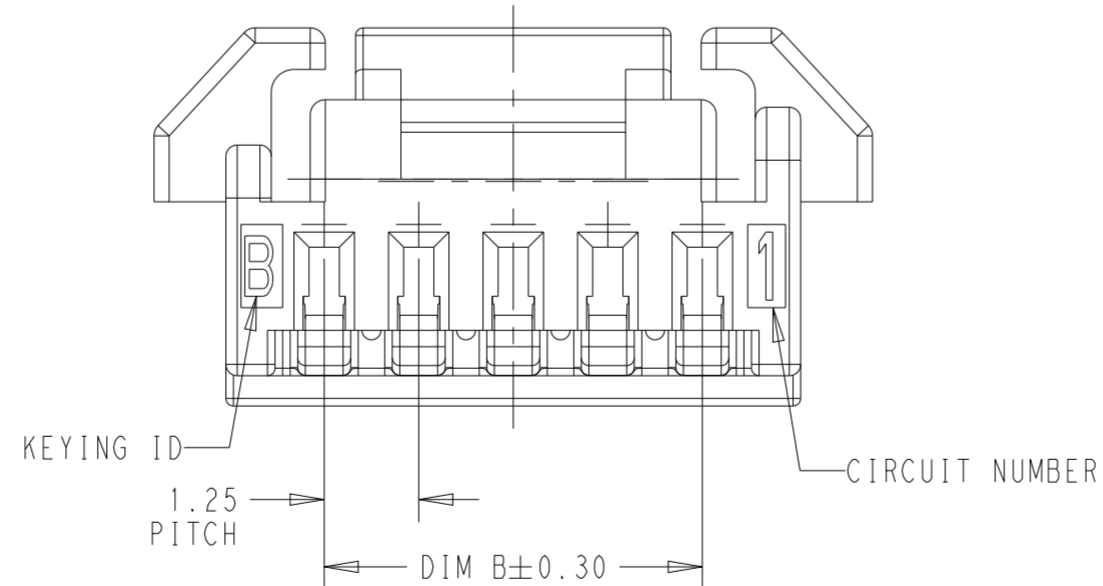
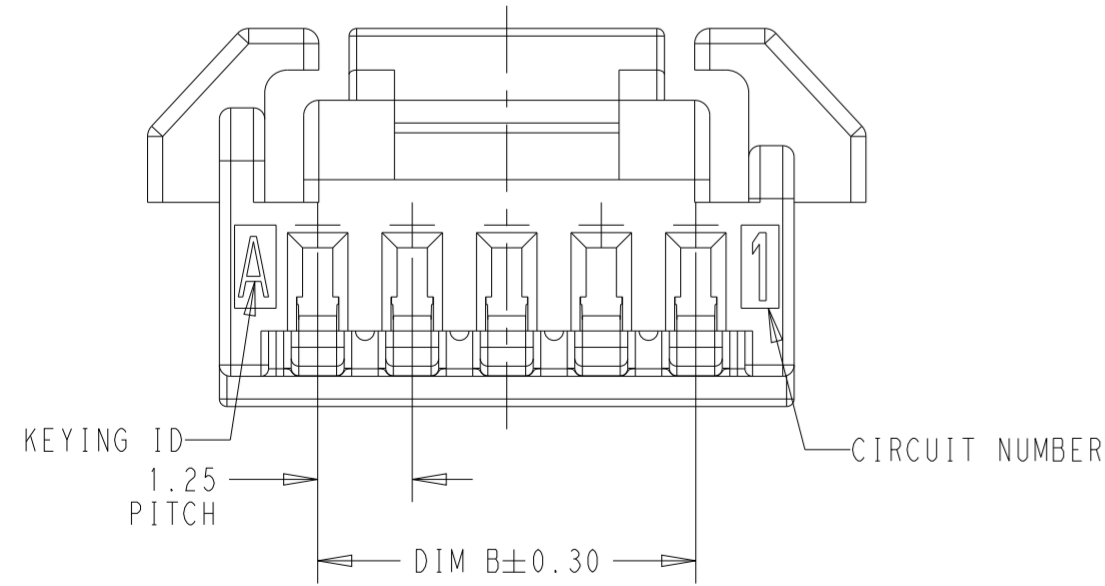
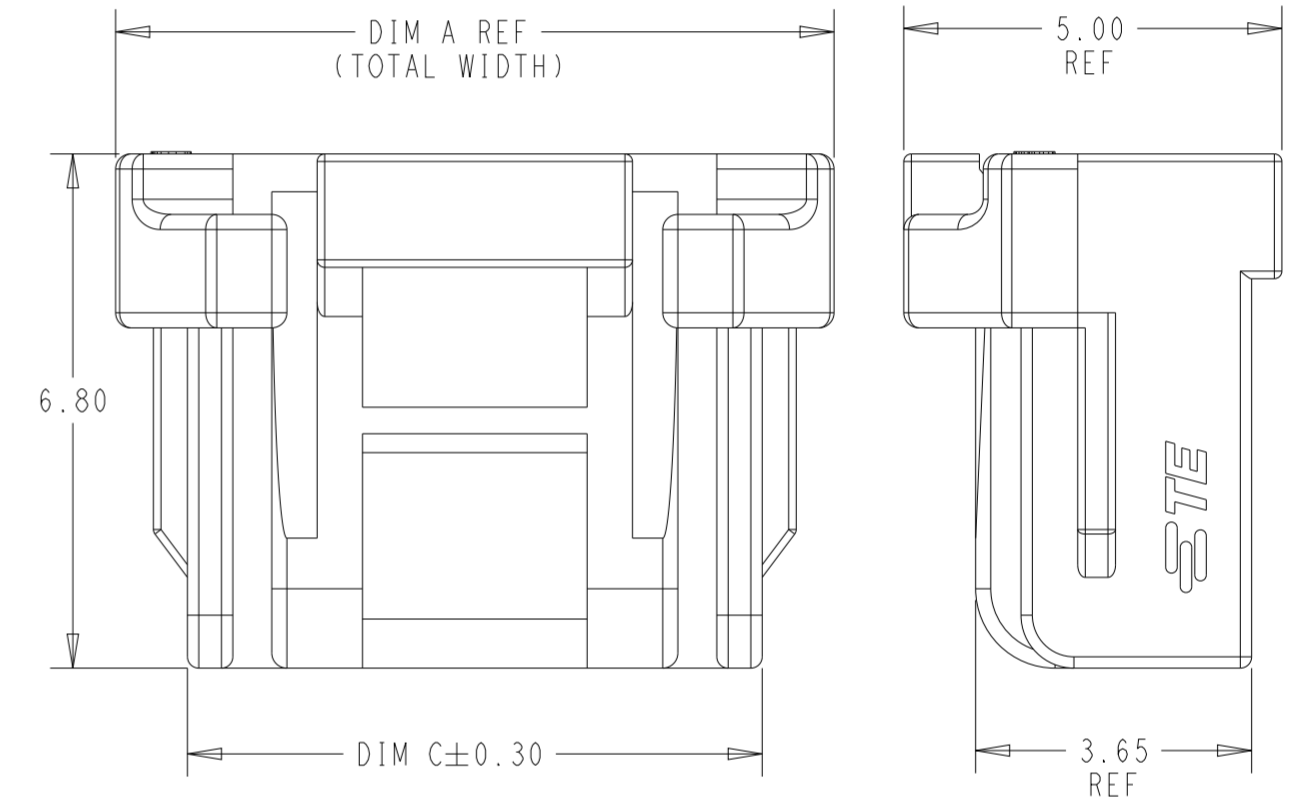
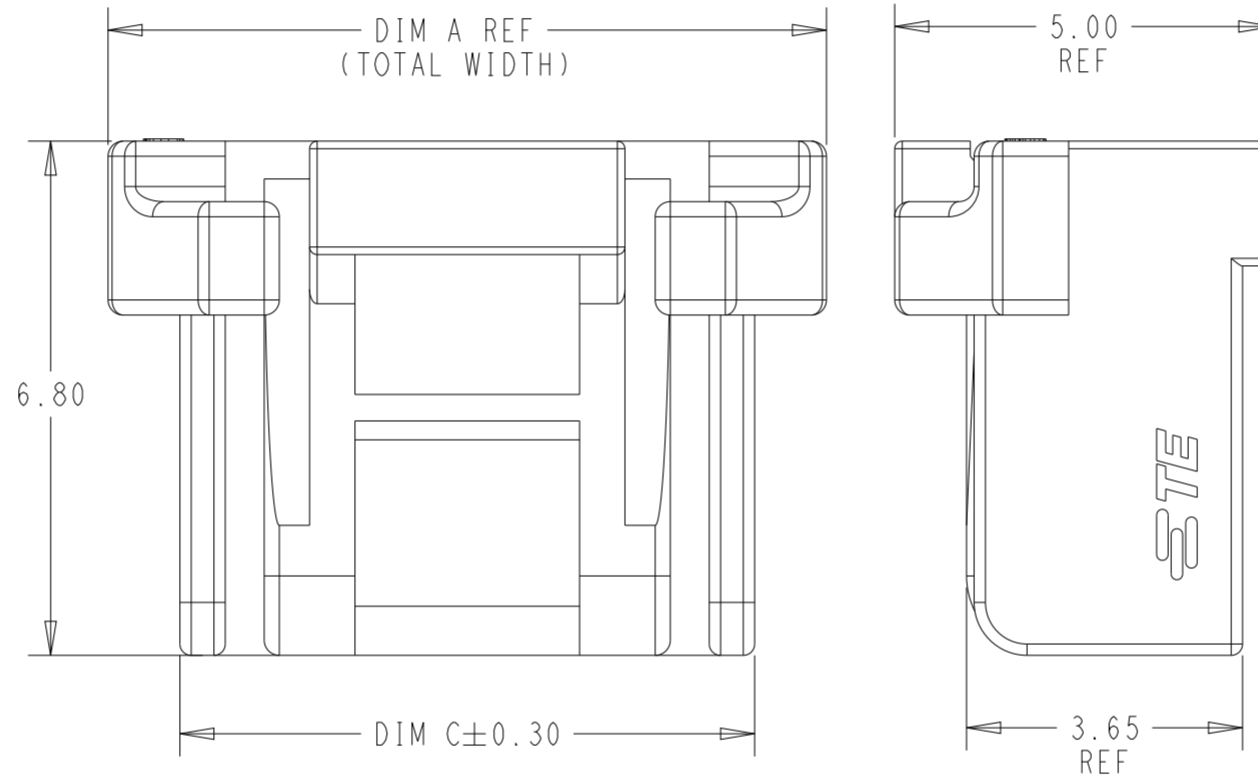
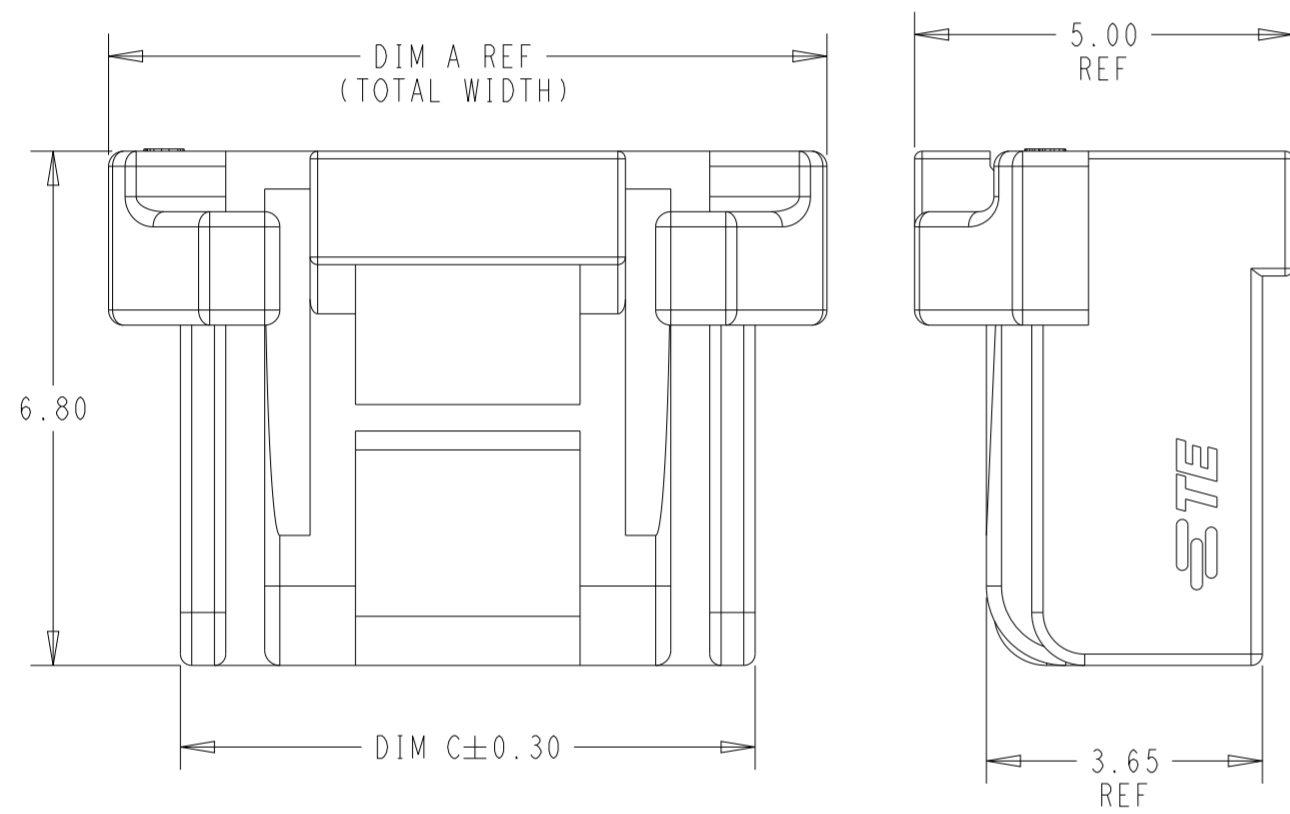
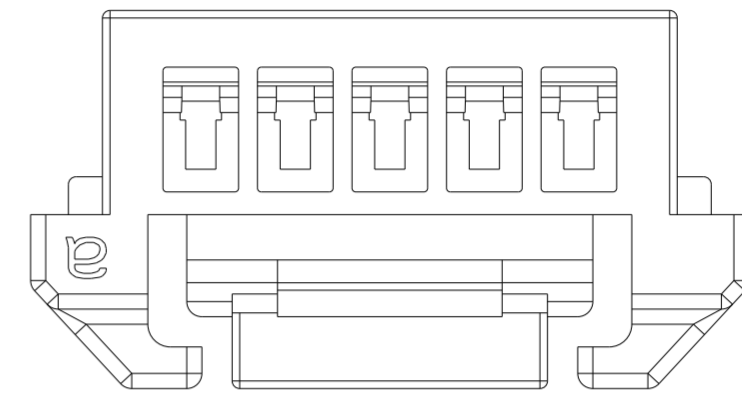

5 POS KEY C
SCALE 5:1

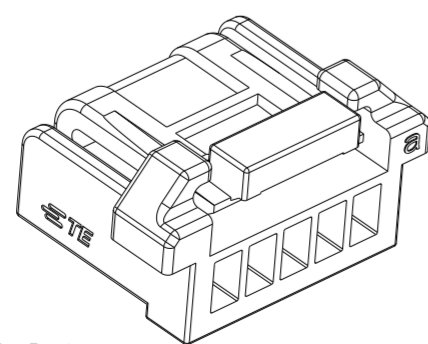

SCALE 5:1
5 POS KEY A

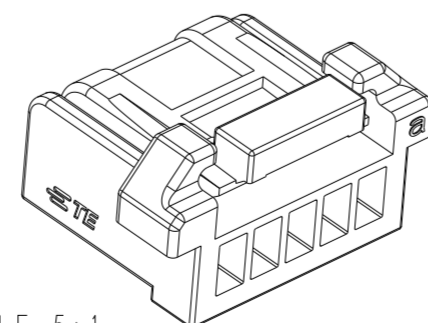

SCALE 5:1
5 POS KEY B

THIS DRAWING IS A CONTROLLED DOCUMENT.		DWN	LEO CHEN	24MAR2020	TE Connectivity	NAME PLUG HOUSING, CRIMP VERSION SGI 1.25					
DIMENSIONS:		CHK	DANIEL ZHANG	24MAR2020							
mm		APVD	DANIEL ZHANG	24MAR2020		PRODUCT SPEC 108-106451					
TOLERANCES UNLESS OTHERWISE SPECIFIED: 0 PLC ±- 1 PLC ±0.30 2 PLC ±0.15 3 PLC ±- 4 PLC ±- ANGLES ±- FINISH -		APPLICATION SPEC 114-106497		SIZE A2		CAGE CODE 00779	DRAWING NO C-2371404	RESTRICTED TO -			
MATERIAL		WEIGHT		CUSTOMER DRAWING		SCALE	10:1	SHEET	1 OF 6	REV	A1

P	LTR	DESCRIPTION	DATE	DWN	APVD
-	-	SEE SHEET 1	-	-	-

KEYING ILLUSTRATION

POS	KEY	KEY A	KEY B	KEY C
7-18 POS				
2-6 POS				

- 1 MATERIAL: NYLON, UL94V-0, COLOR: SEE TABLE.
- 2 APPLICABLE CONTACT P/N: 2371403-1.
- 3 RECOMMENDED MATING PART: SEE TABLE.
- 4 DIMENSIONS SHOW REPRESENT PRODUCT IN DRY, AS MOLDED, CONDITION.

THIS DRAWING IS A CONTROLLED DOCUMENT.		DWN LEO CHEN 24MAR2020	TE Connectivity	
DIMENSIONS: mm		CHK DANIEL ZHANG 24MAR2020		
TOLERANCES UNLESS OTHERWISE SPECIFIED:		APVD DANIEL ZHANG 24MAR2020	NAME PLUG HOUSING, CRIMP VERSION	
0 PLC ±		PRODUCT SPEC 108-106451	SGI 1.25	
1 PLC ±0.30		APPLICATION SPEC 114-106497	SIZE A2	CAGE CODE 00779
2 PLC ±0.15		WEIGHT -	DRAWING NO C-2371404	RESTRICTED TO -
3 PLC ±		CUSTOMER DRAWING	SCALE 5:1	SHEET 2 OF 6
4 PLC ±				REV A1
ANGLES ±				
FINISH				

REVISIONS

P	LTR	DESCRIPTION	DATE	DWN	APVD
-	-	SEE SHEET 1	-	-	-

KEY A SHOWN FOR ALL POSITIONS

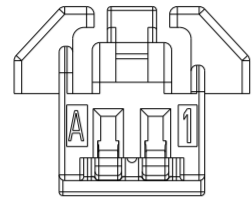

2 POSITION

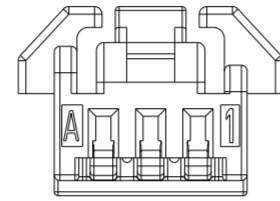

3 POSITION

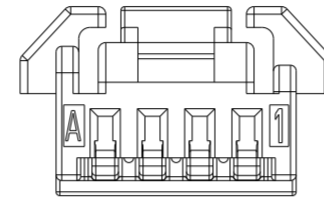

4 POSITION

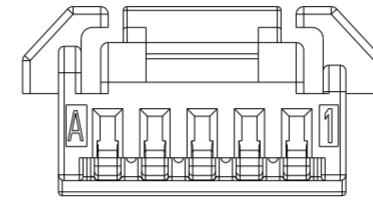

5 POSITION

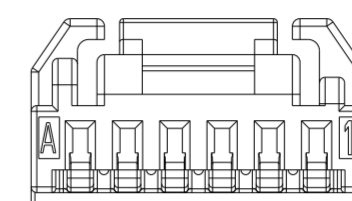

6 POSITION

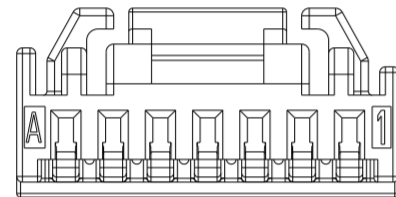

7 POSITION

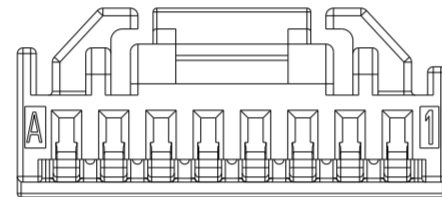

8 POSITION

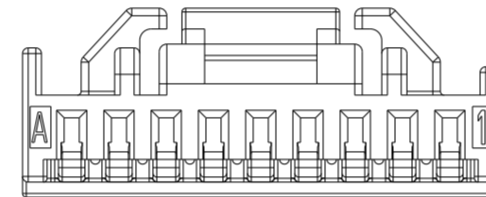

9 POSITION

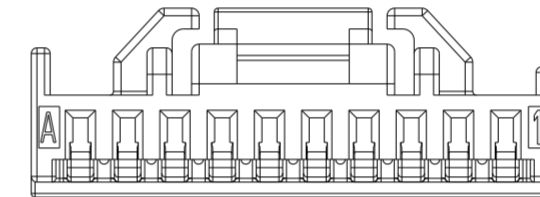

10 POSITION

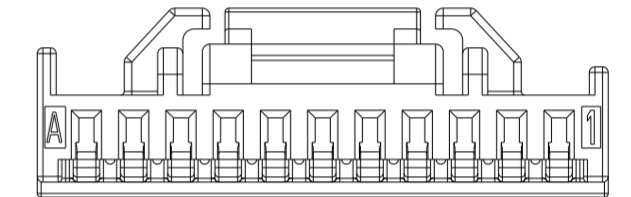

11 POSITION

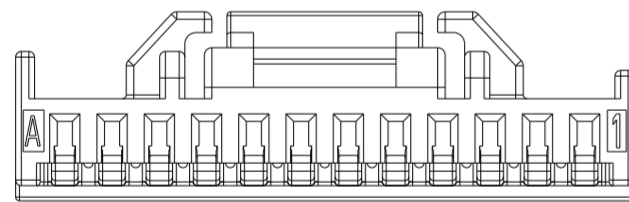

12 POSITION

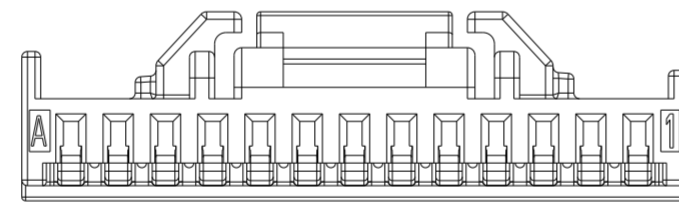

13 POSITION

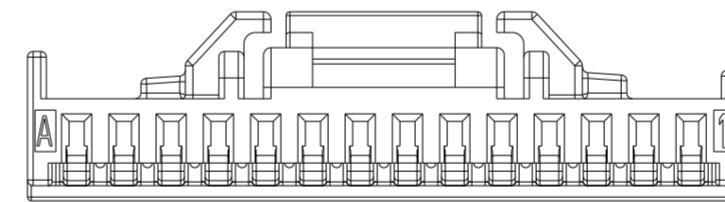

14 POSITION

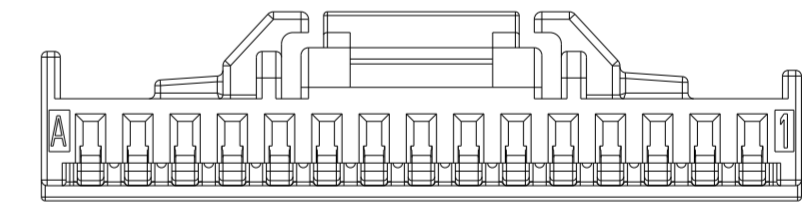

15 POSITION

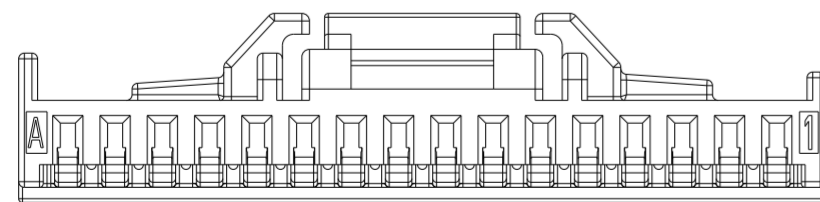

16 POSITION

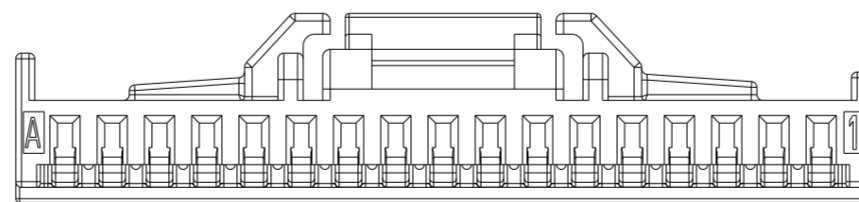

17 POSITION

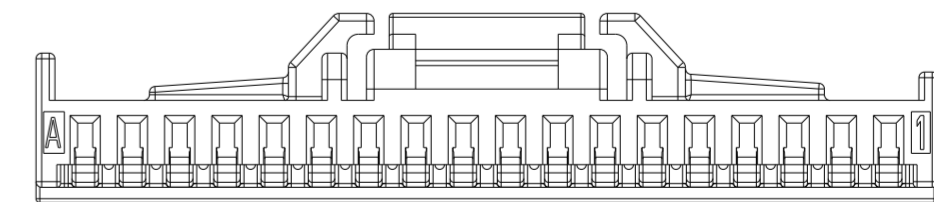

18 POSITION

THIS DRAWING IS A CONTROLLED DOCUMENT.		DWN LEO CHEN 24MAR2020	 TE Connectivity	
DIMENSIONS: mm		CHK DANIEL ZHANG 24MAR2020		
TOLERANCES UNLESS OTHERWISE SPECIFIED:		APVD DANIEL ZHANG 24MAR2020	NAME PLUG HOUSING, CRIMP VERSION SGI 1.25	
0 PLC ±-		PRODUCT SPEC 108-106451	APPLIC. SPEC	
1 PLC ±0.30		114-106497	RESTRICTED TO	
2 PLC ±0.15		WEIGHT	-	
3 PLC ±-		CUSTOMER DRAWING	SCALE	5:1
4 PLC ±-			SHEET	4 OF 6
ANGLES ±-			REV	A1
FINISH ±-				

KEY B SHOWN FOR ALL POSITIONS

REVISIONS				
P	LTR	DESCRIPTION	DATE	APVD
-	-	SEE SHEET 1	-	-

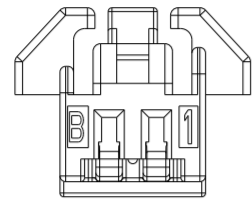

2 POSITION

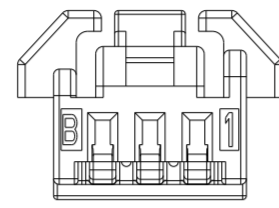

3 POSITION

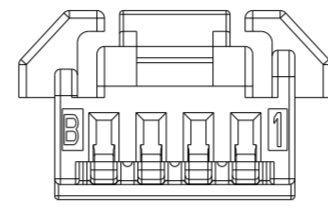

4 POSITION

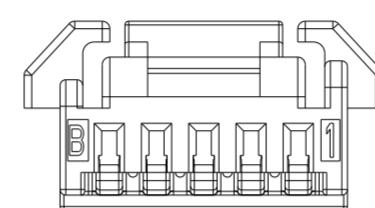

5 POSITION

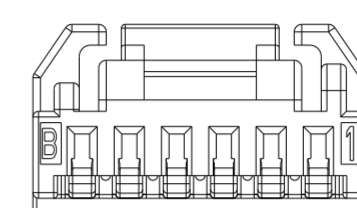

6 POSITION

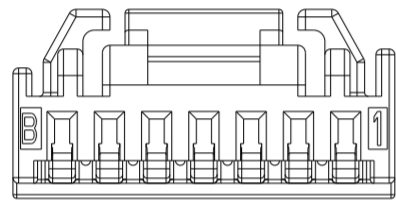

7 POSITION

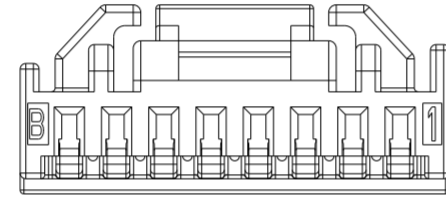

8 POSITION

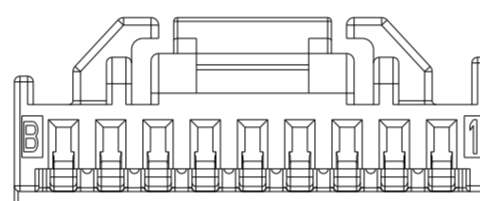

9 POSITION

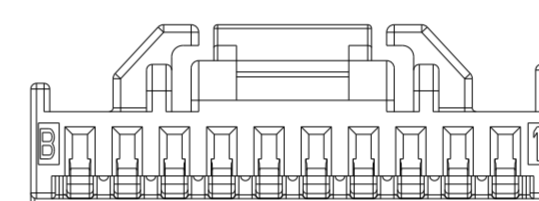

10 POSITION

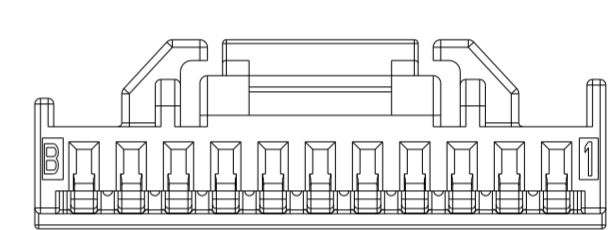

11 POSITION

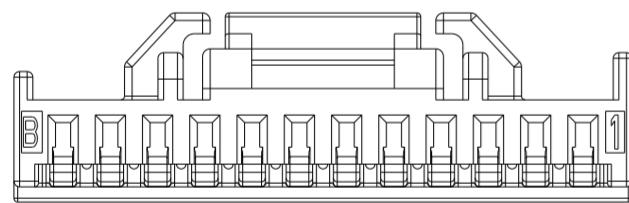

12 POSITION

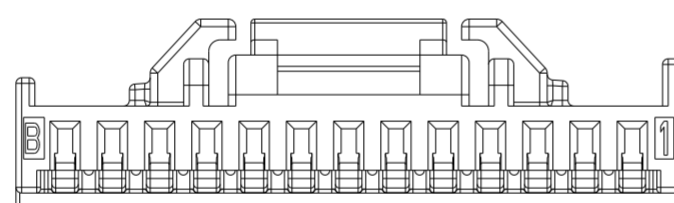

13 POSITION

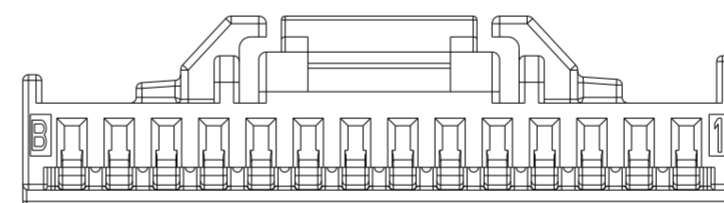

14 POSITION

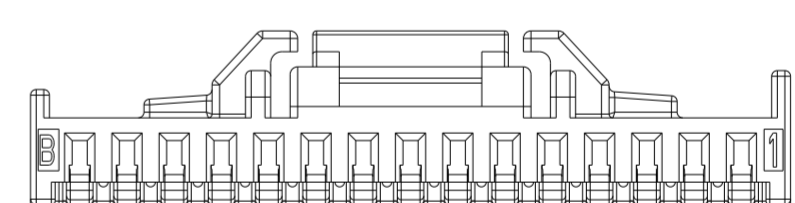

15 POSITION

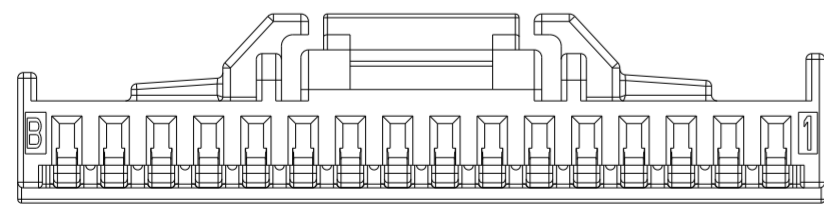

16 POSITION

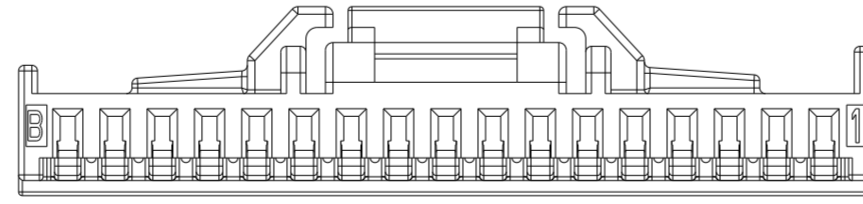

17 POSITION

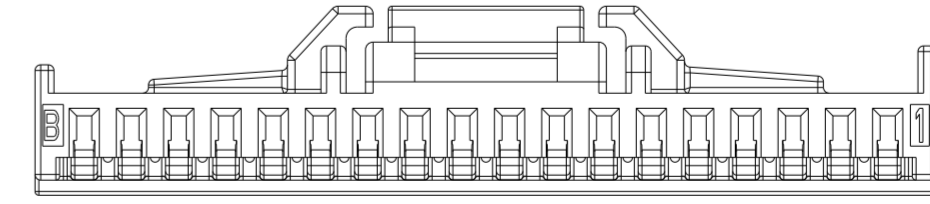

18 POSITION

THIS DRAWING IS A CONTROLLED DOCUMENT.		DWN LEO CHEN 24MAR2020	 TE Connectivity	
DIMENSIONS: mm		CHK DANIEL ZHANG 24MAR2020		
TOLERANCES UNLESS OTHERWISE SPECIFIED: 0 PLC ± 1 PLC ±0.30 2 PLC ±0.15 3 PLC ± 4 PLC ± ANGLES ± FINISH		APVD DANIEL ZHANG 24MAR2020	NAME PLUG HOUSING, CRIMP VERSION SGI 1.25	
MATERIAL -		PRODUCT SPEC 108-106451	SIZE A2	CAGE CODE 00779
		APPLICATION SPEC 114-106497	DRAWING NO C-2371404	
		WEIGHT -	RESTRICTED TO -	
		CUSTOMER DRAWING	SCALE 5:1	SHEET 5 OF 6
			REV A1	

REVISIONS

P	LTR	DESCRIPTION	DATE	DWN	APVD
-	-	SEE SHEET 1	-	-	-

KEY C SHOWN FOR ALL POSITIONS

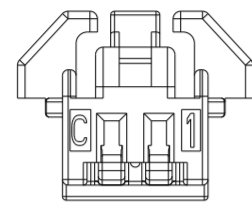

2 POSITION

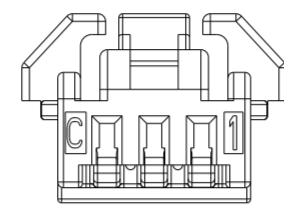

3 POSITION

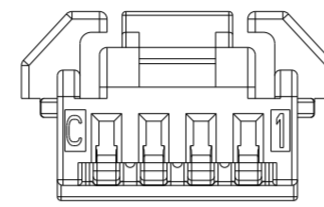

4 POSITION

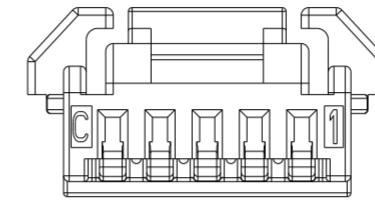

5 POSITION

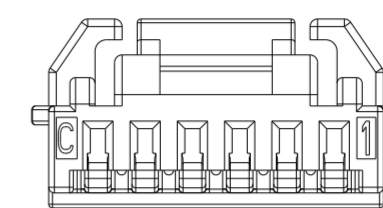

6 POSITION

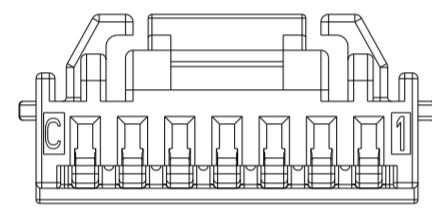

7 POSITION

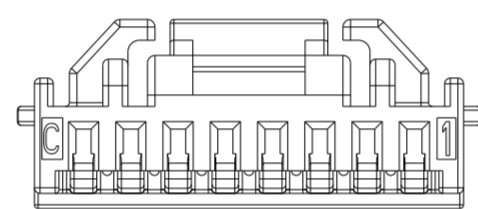

8 POSITION

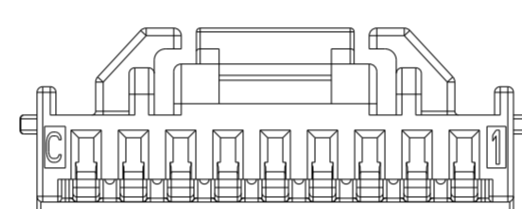

9 POSITION

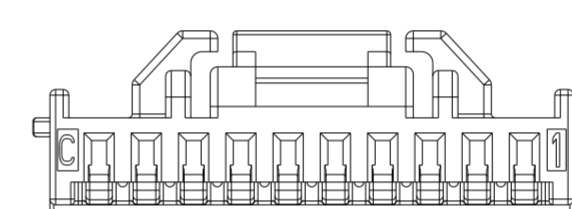

10 POSITION

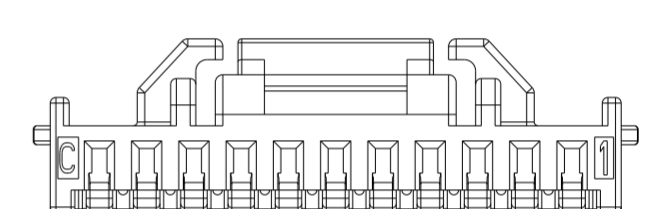

11 POSITION

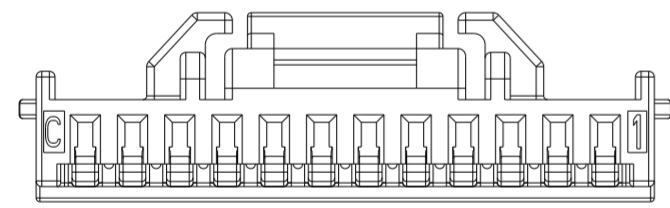

12 POSITION

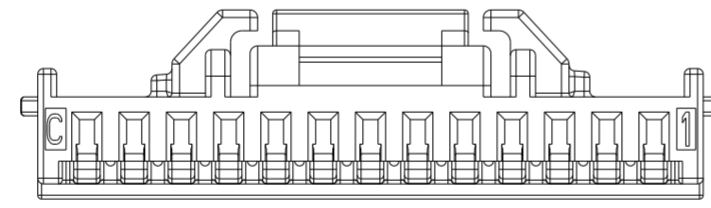

13 POSITION

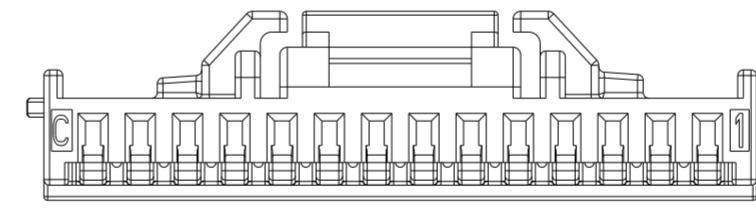

14 POSITION

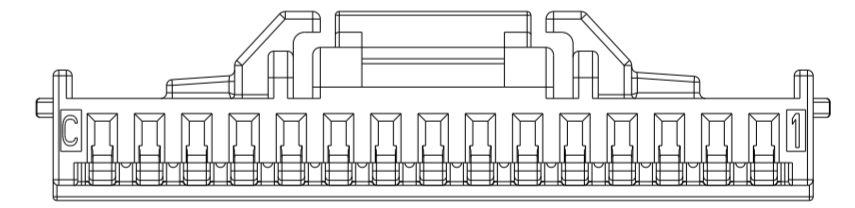

15 POSITION

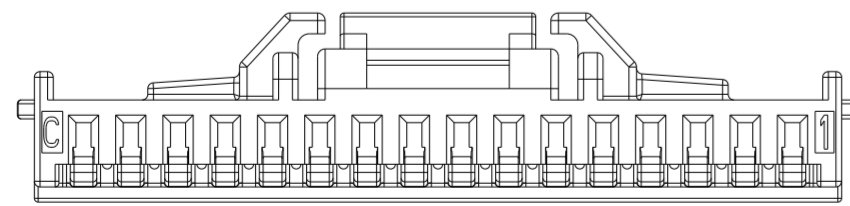

16 POSITION

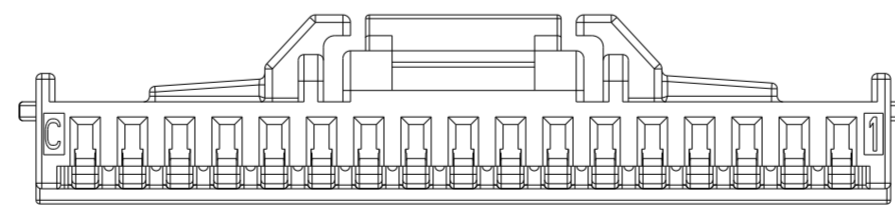

17 POSITION

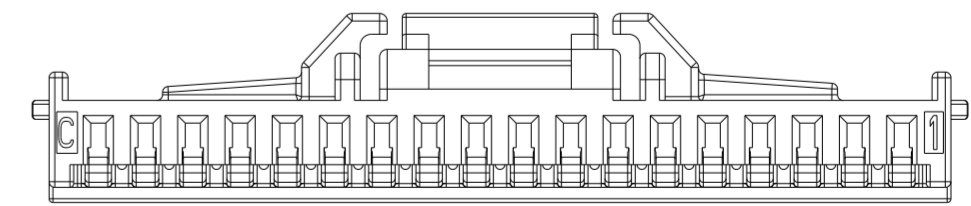

18 POSITION

THIS DRAWING IS A CONTROLLED DOCUMENT.		DWN LEO CHEN 24MAR2020	 TE Connectivity	
DIMENSIONS: mm		CHK DANIEL ZHANG 24MAR2020		
TOLERANCES UNLESS OTHERWISE SPECIFIED: 0 PLC ± 1 PLC ±0.30 2 PLC ±0.15 3 PLC ± 4 PLC ±		APVD DANIEL ZHANG 24MAR2020	NAME PLUG HOUSING, CRIMP VERSION SGI 1.25	
MATERIAL -		PRODUCT SPEC 108-106451	SIZE A2	CAGE CODE 00779
FINISH -		APPLICATION SPEC 114-106497	DRAWING NO C-2371404	RESTRICTED TO -
		WEIGHT -	SCALE 5:1	SHEET 6 OF 6
		CUSTOMER DRAWING	REV A1	

Mouser Electronics

Authorized Distributor

Click to View Pricing, Inventory, Delivery & Lifecycle Information:

[TE Connectivity:](#)

[1-2371404-1](#) [1-2371404-0](#) [1-2371404-6](#) [2371404-8](#) [1-2371404-3](#) [1-2371404-5](#) [2371404-7](#) [2371404-9](#) [1-2371404-7](#) [2371404-3](#) [2371404-5](#) [1-2371404-8](#) [2371404-6](#) [1-2371404-2](#) [1-2371404-4](#) [2371404-2](#) [2371404-4](#)