

P	LTR	DESCRIPTION	DATE	DWN	APVD
A		NEW DRAWING	07MAR2023	BDA	DH
A1		DRAWING CLARIFICATION	21JUL2023	BDA	DH
A2		SPECIFICATIONS NUMBER UPDATED	28SEP2023	BDA	DH

GENERAL TOLERANCES:
 0 - 2mm = ±0.1mm
 2.1mm - 5mm = ±0.15mm
 5.1mm - 9mm = ±0.2mm

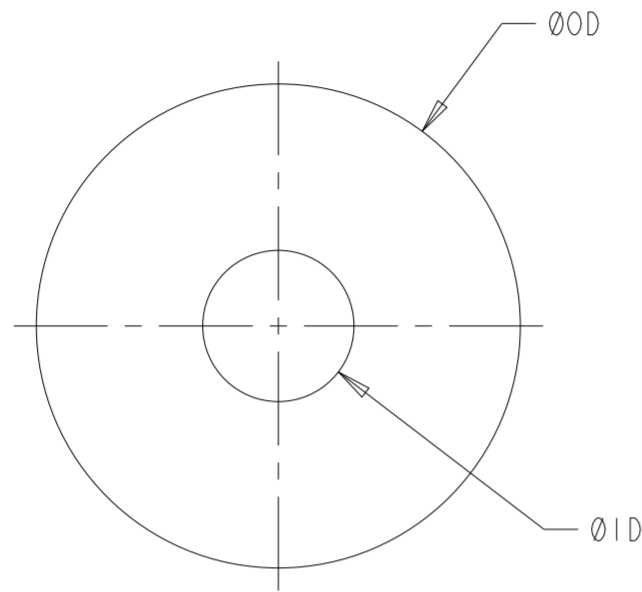

MATERIAL SPECIFIC DATA TABLE

	SNA	FNA
RECOMMENDED OPERATING TEMPERATURE RANGE (°C)	-55 to 125	-55 to 125
SPECIFIC GRAVITY ± 13%	2.000	2.300
SHORE A HARDNESS	70±7	70±7
MAXIMUM VOLUME RESISTIVITY (Ω.CM)	0.1	0.1

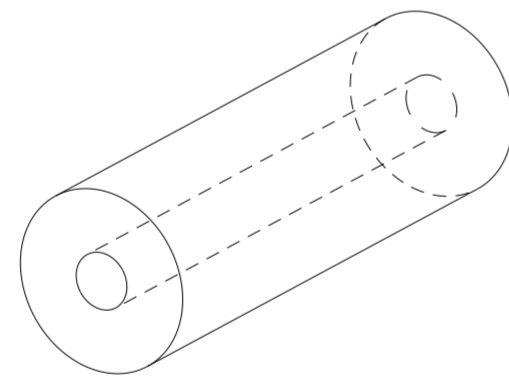

ISOMETRIC VIEW (NTS)

DARK GREEN	3.2	1.1	FLUROSILICONE NICKEL ALUMINIUM	1202-FNA-0032-0011	2452669-1	1202-FNA-0032-0011-1	2452682-1
DARK GREEN	2.6	1.1	FLUROSILICONE NICKEL ALUMINIUM	1202-FNA-0026-0011	2452668-1	1202-FNA-0026-0011-1	2452681-1
DARK GREEN	1.6	0.5	FLUROSILICONE NICKEL ALUMINIUM	1202-FNA-0016-0005	2452667-1	1202-FNA-0016-0005-1	2452680-1
DARK GREY	3.2	1.1	SILICONE NICKEL ALUMINIUM	1202-SNA-0032-0011	2452646-1	1202-SNA-0032-0011-1	2452659-1
DARK GREY	2.6	1.1	SILICONE NICKEL ALUMINIUM	1202-SNA-0026-0011	2452645-1	1202-SNA-0026-0011-1	2452658-1
DARK GREY	1.6	0.5	SILICONE NICKEL ALUMINIUM	1202-SNA-0016-0005	2452644-1	1202-SNA-0016-0005-1	2452657-1
COLOUR	ØOD	ØID	MATERIAL	10 METER LENGTH ALIAS PART NUMBER	10 METER LENGTH PART NUMBER	1 METER LENGTH ALIAS PART NUMBER	1 METER LENGTH PART NUMBER

THIS DRAWING IS A CONTROLLED DOCUMENT.

DIMENSIONS:	TOLERANCES UNLESS OTHERWISE SPECIFIED:
mm	0 PLC ±
	1 PLC ±
	2 PLC ±
	3 PLC ±
	4 PLC ±
	ANGLES ±
	FINISH -

DWN	07MAR2023
CHK	BASAVARAJA D A
APVD	B SELVAPANDIAN
APVD	D HEMMINGS
PRODUCT SPEC	108-120068
APPLICATION SPEC	114-120005
WEIGHT	-
CUSTOMER DRAWING	

STE TE Connectivity	
NAME	1202-NA-ECE EXTRUDED TUBE-SERIES
SIZE	A2
CAGE CODE	00779
DRAWING NO	1202-NA-ECE-TUBE
RESTRICTED TO	-
SCALE	40:1
SHEET	1 OF 1
REV	A2

Mouser Electronics

Authorized Distributor

Click to View Pricing, Inventory, Delivery & Lifecycle Information:

[TE Connectivity:](#)

[2452680-1](#)