

1-1415021-1 ✓ ACTIVE

SCHRACK | SCHRACK Miniature Relay PT

TE Internal #: 1-1415021-1

SCHRACK Miniature Relay PT, Power Relays, Industrial Panel Plug-In, Monostable, DC, 600 – 800mW Coil Power Rating Class, 788mW Coil Power Rating DC

[View on TE.com >](#)



Relays, Contactors & Switches > Relays > Power Relays

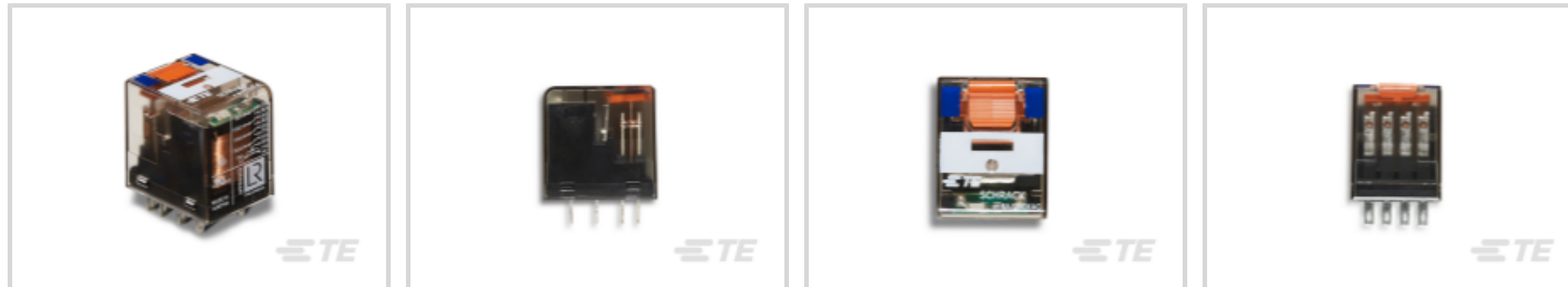

Power Relay Type: **Industrial Panel Plug-In**

Coil Magnetic System: **Monostable, DC**

Coil Power Rating Class: **600 – 800 mW**

Coil Power Rating DC: **788 mW**

Coil Resistance: **3072  $\Omega$**

## Features

### Product Type Features

Power Relay Type	Industrial Panel Plug-In
------------------	--------------------------

### Electrical Characteristics

Insulation Initial Dielectric Between Contacts & Coil	1200 Vrms
Insulation Initial Dielectric Between Open Contacts	1200 Vrms
Contact Limiting Making Current	12 A
Contact Limiting Short-Time Current	300 A
Insulation Creepage Class	3 – 5.5 mm
Insulation Initial Dielectric Between Adjacent Contacts	2500 Vrms
Insulation Creepage Between Contact & Coil	4 mm [.157 in]
Contact Limiting Breaking Current	6 A
Coil Magnetic System	Monostable, DC
Coil Power Rating Class	600 – 800 mW
Coil Power Rating DC	788 mW
Coil Resistance	3072 $\Omega$
Coil Special Features	Electrical Indicator, LED, UL Coil Insulation Class F
Coil Voltage Rating	48 VDC
Contact Switching Load (Min)	10mA @ 12V



Contact Switching Voltage (Max)	240 VAC
---------------------------------	---------

Contact Voltage Rating	240 VAC
------------------------	---------

### Body Features

Insulation Special Features	5000V Initial Surge Withstand Voltage between Contacts & Coil
-----------------------------	---

Product Weight	30 g[1.058 oz]
----------------	----------------

### Contact Features

Contact Arrangement	4 Form C (4 CO)
---------------------	-----------------

Contact Current Class	5 – 10 A
-----------------------	----------

Contact Current Rating (Max)	6 A
------------------------------	-----

Contact Material	AgNi90/10
------------------	-----------

Contact Number of Poles	4
-------------------------	---

Relay Terminal Type	Plug-In, Solder
---------------------	-----------------

### Mechanical Attachment

Relay Mounting Type	Socket
---------------------	--------

### Dimensions

Length Class (Mechanical)	25 – 30 mm
---------------------------	------------

Dimensions (L x W x H) (Approximate)	28 x 22.5 x 29 mm[1.102 x .886 x 1.142 in]
--------------------------------------	--

Insulation Clearance Class	2.5 – 4 mm
----------------------------	------------

Height Class (Mechanical)	25 – 30 mm
---------------------------	------------

Insulation Clearance Between Contact & Coil	3 mm
---	------

Width Class (Mechanical)	20 – 25 mm
--------------------------	------------

Product Width	22.5 mm[.886 in]
---------------	------------------

Product Length	28 mm[1.102 in]
----------------	-----------------

Product Height	29 mm[1.142 in]
----------------	-----------------

### Usage Conditions

Environmental Ambient Temperature (Max)	70 °C[158 °F]
---	---------------

Operating Temperature Range	-40 – 70 °C
-----------------------------	-------------

### Packaging Features

Packaging Method	Carton & Tube
------------------	---------------

### Product Compliance

For compliance documentation, visit the product page on [TE.com](https://www.te.com)>









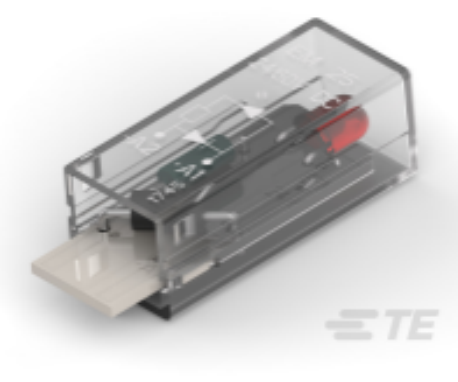

EU RoHS Directive 2011/65/EU	Compliant
EU ELV Directive 2000/53/EC	Out of Scope
China RoHS 2 Directive MIIT Order No 32, 2016	No Restricted Materials Above Threshold
EU REACH Regulation (EC) No. 1907/2006	Current ECHA Candidate List: JUL 2021 (219) Candidate List Declared Against: JAN 2017 (173) SVHC > Threshold: Not Yet Reviewed
Halogen Content	Not Low Halogen - contains Br or Cl > 900 ppm.
Solder Process Capability	Hand solderable with lead free solder

Product Compliance Disclaimer

This information is provided based on reasonable inquiry of our suppliers and represents our current actual knowledge based on the information they provided. This information is subject to change. The part numbers that TE has identified as EU RoHS compliant have a maximum concentration of 0.1% by weight in homogenous materials for lead, hexavalent chromium, mercury, PBB, PBDE, DBP, BBP, DEHP, DIBP, and 0.01% for cadmium, or qualify for an exemption to these limits as defined in the Annexes of Directive 2011/65/EU (RoHS2). Finished electrical and electronic equipment products will be CE marked as required by Directive 2011/65/EU. Components may not be CE marked. Additionally, the part numbers that TE has identified as EU ELV compliant have a maximum concentration of 0.1% by weight in homogenous materials for lead, hexavalent chromium, and mercury, and 0.01% for cadmium, or qualify for an exemption to these limits as defined in the Annexes of Directive 2000/53/EC (ELV). Regarding the REACH Regulation, the information TE provides on SVHC in articles for this part number is based on the latest European Chemicals Agency (ECHA) 'Guidance on requirements for substances in articles' posted at this URL: <https://echa.europa.eu/guidance-documents/guidance-on-reach>

## Compatible Parts

 <p>TE Part # 5-1415539-3 PTML0060</p>	 <p>TE Part # 1-1415526-1 PT78742</p>	 <p>TE Part # 2-1415526-1 PT17021</p>	 <p>TE Part # 6-1415037-1 PT17040</p>
 <p>TE Part # 1860000-1 PT7874P</p>	 <p>TE Part # 9-1415036-1 PTMT00A0</p>	 <p>TE Part # 5-1415037-1 PT17016</p>	 <p>TE Part # 5-1419111-9 PT28800</p>



Also in the Series | **SCHRACK Miniature Relay PT**

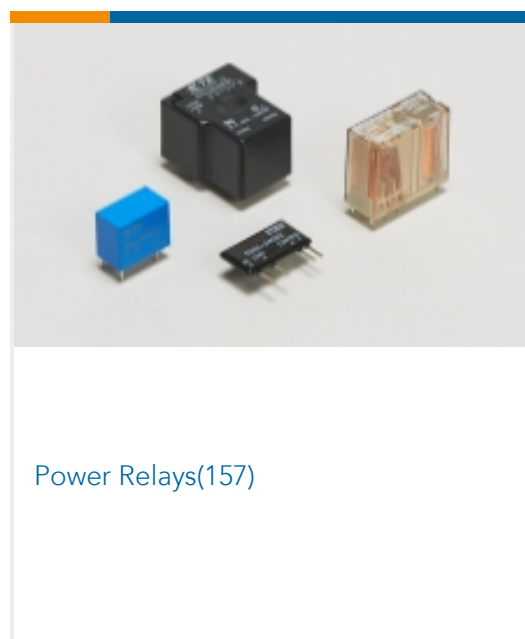

Customers Also Bought



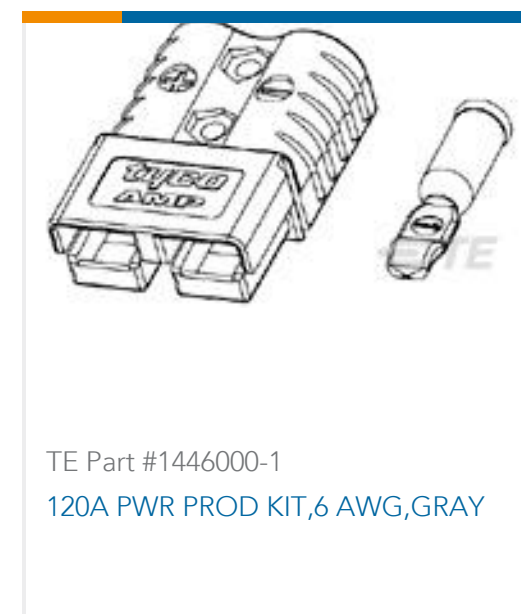

## Documents

### CAD Files

#### 3D PDF

3D

#### Customer View Model

[ENG\\_CVM\\_CVM\\_1-1415021-1\\_O.2d\\_dxf.zip](#)

English

#### Customer View Model

[ENG\\_CVM\\_CVM\\_1-1415021-1\\_O.3d\\_igs.zip](#)

English

#### Customer View Model

[ENG\\_CVM\\_CVM\\_1-1415021-1\\_O.3d\\_stp.zip](#)

English

By downloading the CAD file I accept and agree to the [Terms and Conditions](#) of use.

### Datasheets & Catalog Pages

#### Miniature Relay PT

English

### Product Specifications

#### Definitions, Handling, Processing, Testing and Use of Relays

English

### Agency Approvals

#### VDE Certificate

English

# Mouser Electronics

Authorized Distributor

Click to View Pricing, Inventory, Delivery & Lifecycle Information:

[TE Connectivity:](#)

[1-1415021-1](#)