

4

3

2

1

THIS DRAWING IS UNPUBLISHED.



RELEASED FOR PUBLICATION

ALL RIGHTS RESERVED.

© COPYRIGHT - By -

REVISIONS

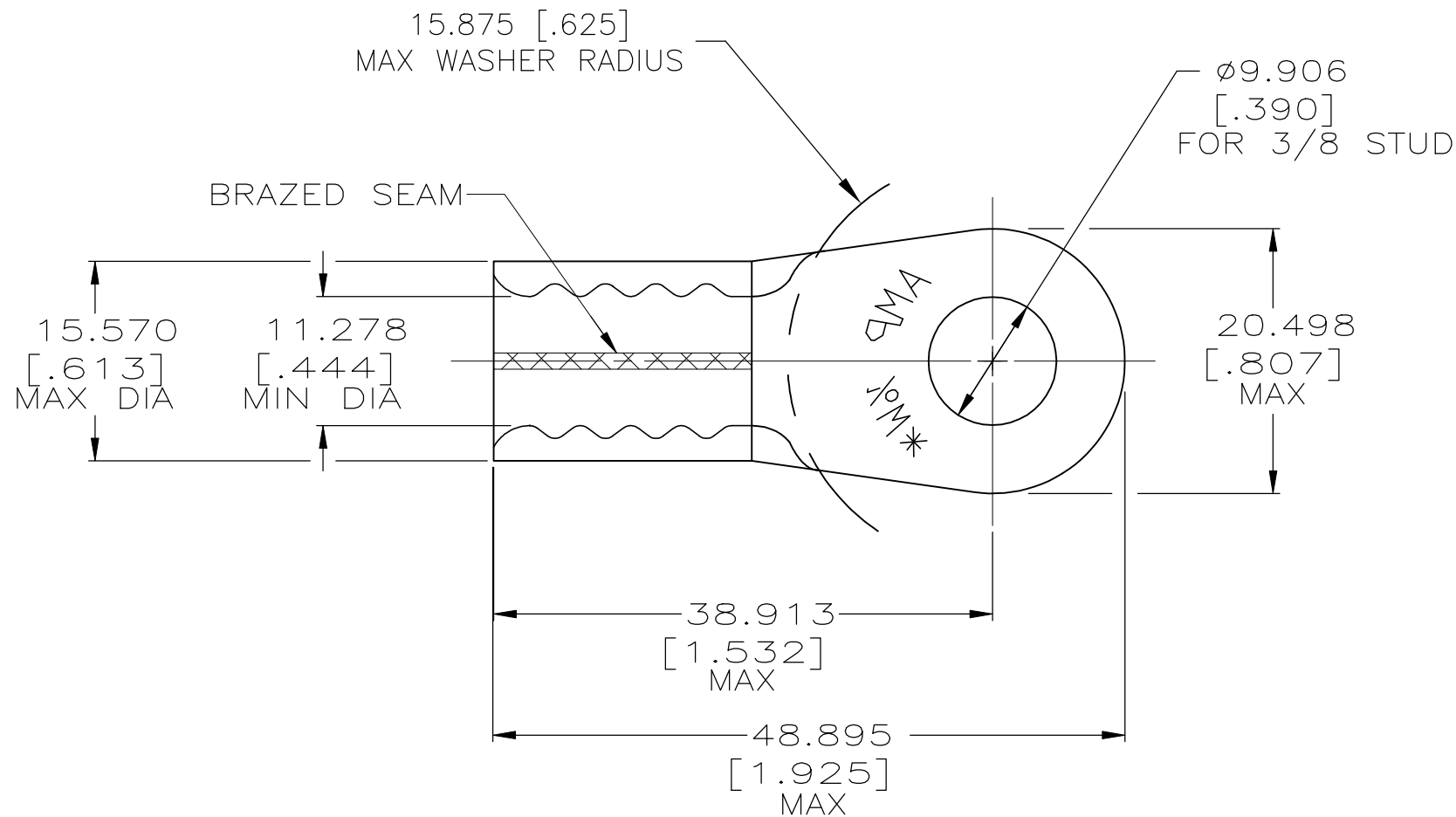

P	LTR	DESCRIPTION	DATE	DWN	APVD
G3		REVISED PER ECO-17-004099	24AUG2017	BDA	DR
G4		REVISED PER ECO-18-010020	26JUN2018	RS	DR

AMP WIRE RANGE	 E13288 Listed
1/0 AWG SOLID OR STRANDED	1/0 AWG STRANDED
 LR7189 Certified	MILITARY P/N AND CLASS 
1/0 AWG SOLID OR STRANDED	MS 20659-118 CLASS 2



 TIN PL 0.00254[.000100] MIN EXT. THK PER ASTM B-545

2 NOTE DELETED

	50	LOOSE PIECE	CLEANED	COPPER ASTM B-152 1.778±0.076[.070±.003] ANNEALED	2-321868-2
	50	LOOSE PIECE			321868
	QTY.	PACKAGE TYPE	FINISH	MATERIAL	PART NUMBER

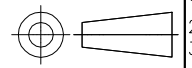
MAX RECOMMENDED OPERATING TEMPERATURE: 170°[338°F]C	THIS DRAWING IS A CONTROLLED DOCUMENT.		DWN DK SCHRUM 8/30/91	 TE Connectivity Ltd.
	VOLTAGE RATING: N/A	DIMENSIONS: INCHES	CHK RD HEIM 9/30/91	
CIRCULAR MIL AREA: 42.4-60.6mm²[83,700-119,500] SOLID OR STRANDED		TOLERANCES UNLESS OTHERWISE SPECIFIED: 0 PLC ± - 1 PLC ± - 2 PLC ± - 3 PLC ± 0.127[.005] 4 PLC ± - ANGLES ± -	APVD AJ KAUFMAN 9/30/91	TERMINAL, RING TONGUE, SOLISTRAND WIRE SIZE 50.0mm² [1/0] AWG
			MATERIAL SEE TABLE	
			APPLICATION SPEC -	SIZE A3
			WEIGHT -	CAGE CODE 00779
			CUSTOMER DRAWING	DRAWING NO C-321868
				RESTRICTED TO -
				SCALE 2:1
				SHEET 1 of 1
				REV G4

Mouser Electronics

Authorized Distributor

Click to View Pricing, Inventory, Delivery & Lifecycle Information:

[TE Connectivity:](#)

[MS20659-118](#)