

Type CPF Series

Key Features

Thin film precision resistors with TC's to 15ppm and tolerances to 0.05%.

Wide range of case sizes from 0201 to 2512

Suitable for all applications where close accuracy and stability are essential

Terminal finish – electroplated 100% matte Sn



Applications

Communications

Industrial Controls

Instrumentation

Medical

The CPF series is a high stability precision chip resistor range offering various power dissipations relating to a wide range of chip sizes. The CPF series offers TCR's down to 15ppm/°C and resistance tolerances to 0.1%. Standard values are within the IEC 63 E96 and E24 value grids. The CPF has accurate and uniform physical dimensions to facilitate placement

Electrical Characteristics

Chip Size	0201						
Rated Power @70°C	0.03125W						
Resistance Range Ω	Min.	49R9	49R9	49R9	49R9	49R9	49R9
	Max	75K	75K	75K	75K	75K	75K
Tolerance	0.1		0.5		1		
Code Letter	B		D		F		
Selection series	E24 & E96						
Temp. Coefficient (ppm/°C)	25	50	25	50	25	50	
Code Letter	E	C	E	C	E	C	
Operating Voltage (Max)	15V						
Max. Overload Voltage	30V						
Operating Temp. Range	-55 ~ +155°C						
Insulation Resistance dry min.	>1000M Ω						
Stability	0.5%						

Chip Size	0402											
Rated Power @70°C	0.063W											
Resistance Range Ω	Min.	49R9			4R02		4R02		49R9		4R02	
	Max	20K			100K		511K		100K		511K	
Tolerance (%)	0.05			0.1			0.5			1		
Code Letter	A			B			D			F		
Selection series	E24 & E96											
T.C.R. (ppm/°C)	15	25	50	15	25	50	15	25	50	15	25	50
Code Letter	D	E	C	D	E	C	D	E	C	D	E	C
Max Operating Volt.	25V											
Max. Overload Volt.	50V											
Op. Temp. Range	-55 ~ +155°C											
Insulation Resistance	>1000M Ω											
Stability	0.5%											

Chip Size	0603											
Rated Power @70°C	0.063W											
Resistance Range Ω	Min.	4R7			4R7		1R0		4R7		1R0	
	Max	332K			511K		1M0		511K		1M0	
Tolerance (%)	0.05			0.1			0.5			1		
Code Letter	A			B			D			F		
Selection series	E24 & E96											
T.C.R. (ppm/°C)	15	25	50	15	25	50	15	25	50	15	25	50
Code Letter	D	E	C	D	E	C	D	E	C	D	E	C
Max Operating Volt.	50V											
Max. Overload Volt.	100V											
Op. Temp. Range	-55 ~ +155°C											
Insulation Resistance	>1000M Ω											
Stability	0.5%											

Chip Size	0805											
Rated Power @70°C	0.1W											
Resistance Range Ω	Min.	4R7			4R7		1R0		4R7		1R0	
	Max	1M0			1M0		2M0		1M0		2M0	
Tolerance (%)	0.05			0.1			0.5			1		
Code Letter	A			B			D			F		
Selection series	E24 & E96											
T.C.R. (ppm/°C)	15	25	50	15	25	50	15	25	50	15	25	50
Code Letter	D	E	C	D	E	C	D	E	C	D	E	C
Max Operating Volt.	100V											
Max. Overload Volt.	200V											
Op. Temp. Range	-55 ~ +155°C											
Insulation Resistance	>1000M Ω											
Stability	0.5%											

Chip Size	1206											
Rated Power @70°C	0.125W											
Resistance Range Ω	Min.	4R7	4R7	4R7	1R0	4R7	1R0	4R7	1R0			
	Max	1M5	1M0	1M5	2M49	1M5	2M49	1M5	2M49			
Tolerance (%)	0.05			0.1			0.5			1		
Code Letter	A			B			D			F		
Selection series	E24 & E96											
T.C.R. (ppm/°C)	15	25	50	15	25	50	15	25	50	15	25	50
Code Letter	D	E	C	D	E	C	D	E	C	D	E	C
Max Operating Volt.	150V											
Max. Overload Volt.	300V											
Op. Temp. Range	-55 ~ +155°C											
Insulation Resistance	>1000M Ω											
Stability	0.5%											

Chip Size	1210											
Rated Power @70°C	0.25W											
Resistance Range Ω	Min.	4R7	4R7	1R0	4R7	1R0	4R7	1R0				
	Max	1M0	1M0	2M49	1M0	2M49	1M0	2M49				
Tolerance (%)	0.05			0.1			0.5			1		
Code Letter	A			B			D			F		
Selection series	E24 & E96											
T.C.R. (ppm/°C)	15	25	50	15	25	50	15	25	50	15	25	50
Code Letter	D	E	C	D	E	C	D	E	C	D	E	C
Max Operating Volt.	150V											
Max. Overload Volt.	300V											
Op. Temp. Range	-55 ~ +155°C											
Insulation Resistance	>1000M Ω											
Stability	0.5%											

Chip Size	2010											
Rated Power @70°C	0.25W											
Resistance Range Ω	Min.	4R7	4R7	1R0	4R7	1R0	4R7	1R0				
	Max	1M0	1M0	3M0	1M0	3M0	1M0	3M0				
Tolerance (%)	0.05			0.1			0.5			1		
Code Letter	A			B			D			F		
Selection series	E24 & E96											
T.C.R. (ppm/°C)	15	25	50	15	25	50	15	25	50	15	25	50
Code Letter	D	E	C	D	E	C	D	E	C	D	E	C
Max Operating Volt.	150V											
Max. Overload Volt.	300V											
Op. Temp. Range	-55 ~ +155°C											
Insulation Resistance	>1000M Ω											
Stability	0.5%											

Chip Size	2512												
Rated Power @70°C	0.5W												
Resistance Range Ω	Min.	4R7			1R0			4R7			1R0		
	Max	1M0			3M0			1M0			3M0		
Tolerance (%)	0.05			0.1			0.5			1			
Code Letter	A			B			D			F			
Selection series	E24 & E96												
T.C.R. (ppm/°C)	15	25	50	15	25	50	15	25	50	15	25	50	
Code Letter	D	E	C	D	E	C	D	E	C	D	E	C	
Max Operating Volt.	150V												
Max. Overload Volt.	300V												
Op. Temp. Range	-55 ~ +155°C												
Insulation Resistance	>1000MΩ												
Stability	0.5%												

Environmental Characteristics

Item	Requirement		Test Method
	Tol. ≤0.05%	TOL. >0.05%	
Temperature Coefficient of Resistance (TCR)	As per TCRs specified in Electrical Characteristics tables		MIL-STD-202 Method 304 +25/-55/+25/+125/+25°C
Short Time Overload	ΔR±0.05%	ΔR±0.2%	JIS-C-5201-1 5.5 RCWV*2.5 or Max. overload voltage whichever is lower for 5 seconds
Insulation Resistance	>9999 MΩ		MIL-STD-202 Method 302 Apply 100VDC for 1 minute
Endurance	ΔR±0.05%	ΔR±0.2%	MIL-STD-202 Method 108A 70±2°C, RCWV for 1000 hrs with 1.5 hrs "ON" and 0.5 hrs "OFF"
	0201: >7kΩ ΔR±0.5% ≤7kΩ ΔR±0.2%		
Damp Heat with Load	ΔR±0.05%	ΔR±0.3%	MIL-STD-202 Method 103B 40±2°C, 90~95% R.H. RCWV for 1000 hrs with 1.5 hrs "ON" and 0.5 hrs "OFF"
Bending Strength	ΔR±0.05%	ΔR±0.1%	JIS-C-5201-1 6.1.4 Bending amplitude 3 mm for 10 seconds
Solderability	95% min. coverage		MIL-STD-202 Method 208H 245±5°C for 3 seconds
Resistance to Soldering Heat	ΔR±0.05%	ΔR±0.1%	MIL-STD-202 Method 210E 260±5°C for 10 seconds
Dielectric Withstand Voltage	By Type		MIL-STD-202 Method 301 Max. overload voltage for 1 minute
Thermal Shock	ΔR±0.05%	ΔR±0.2%	MIL-STD-202 Method 107G -55°C ~150°C, 100 cycles
Low Temperature Operation	ΔR±0.05%	ΔR±0.2%	JIS-C-5201-1 7.1 1 hour, -65°C, followed by 45 minutes of RCWV
High Temperature Exposure	ΔR±0.5%		MIL-STD-202 Method 107G At +155°C for 1000 hours

RCWV(Rated continuous working voltage)= $\sqrt{P \cdot R}$ or Max. Operating voltage whichever is lower

Storage Temperature: 25±3°C; Humidity < 80%RH

Derating Curve

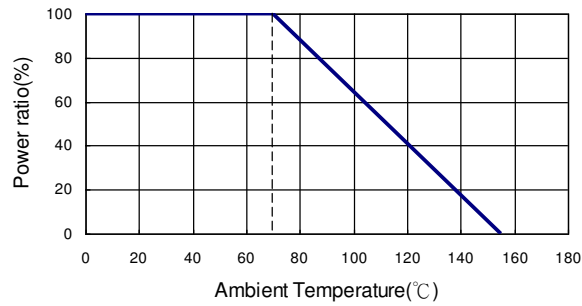

Construction and dimensions

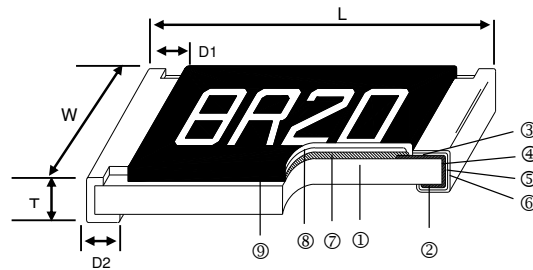

① Alumina Substrate	④ Edge Electrode (NiCr)	⑦ Resistor Layer (NiCr)
② Bottom Electrode (Ag)	⑤ Barrier Layer (Ni)	⑧ Overcoat (Epoxy)
③ Top Electrode (Ag)	⑥ External Electrode (Sn)	⑨ Marking

Size	L (mm)	W (mm)	T (mm)	D1 (mm)	D2 (mm)	Weight (g) (1000 Pcs.)
0201	0.58±0.05	0.29±0.05	0.23±0.05	0.12±0.05	0.15±0.05	0.14
0402	1.00±0.05	0.50±0.05	0.30±0.05	0.20±0.10	0.20±0.10	0.54
0603	1.55±0.10	0.80±0.10	0.45±0.10	0.30±0.20	0.30±0.20	1.83
0805	2.00±0.15	1.25±0.15	0.55±0.10	0.30±0.20	0.40±0.20	4.71
1206	3.05±0.15	1.55±0.15	0.55±0.10	0.42±0.20	0.35±0.25	9.02
1210	3.10±0.15	2.40±0.15	0.55±0.10	0.40±0.20	0.55±0.25	10
2010	4.90±0.15	2.40±0.15	0.55±0.10	0.60±0.30	0.50±0.25	23.61
2512	6.30±0.15	3.10±0.15	0.55±0.10	0.60±0.30	0.50±0.25	38.06

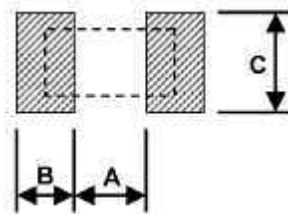

Size	Recommended Land Pattern		
	A	B	C
0201	0.25	0.30	0.40±0.2
0402	0.50	0.50	0.60±0.2
0603	0.80	1.00	0.90±0.2
0805	1.00	1.00	1.35±0.2
1206	2.00	1.15	1.70±0.2
1210	2.00	1.15	2.50±0.2
2010	3.60	1.40	2.50±0.2
2512	4.90	1.60	3.10±0.2

Marking

Case sizes 0805 to 2512 IEC 4 Digit Marking:

Resistance	100R (100Ω)	2K2 (2.2kΩ)	10K (10kΩ)	499K (499kΩ)	100K (100kΩ)
Code	1000	2201	1002	4992	1003

Case Size 0603 E24 3 digit marking – Example 101 = 100R 102=1K0

E24	10	11	12	13	15	16	18	20	22	24	27	30
	33	36	39	43	47	51	56	62	68	75	82	91

Case size 0603 E96 3 digit marking – Examples 14C = 13K7 68B = 4K99 68X = 49R9

Code	E96	Code	E96	Code	E96	Code	E96
01	100	25	178	49	316	73	562
02	102	26	182	50	324	74	576
03	105	27	187	51	332	75	590
04	107	28	191	52	340	76	604
05	110	29	196	53	348	77	619
06	113	30	200	54	357	78	634
07	115	31	205	55	365	79	649
08	118	32	210	56	374	80	665
09	121	33	215	57	383	81	681
10	124	34	221	58	392	82	698
11	127	35	226	59	402	83	715
12	130	36	232	60	412	84	732
13	133	37	237	61	422	85	750
14	137	38	243	62	432	86	768
15	140	39	249	63	442	87	787
16	143	40	255	64	453	88	806
17	147	41	261	65	464	89	825
18	150	42	267	66	475	90	845
19	154	43	274	67	487	91	866
20	158	44	280	68	499	92	887
21	162	45	287	69	511	93	909
22	165	46	294	70	523	94	931
23	169	47	301	71	536	95	953
24	174	48	309	72	549	96	976

Code	A	B	C	D	E	F	G	H	X	Y	Z
Multiplier	10 ⁰	10 ¹	10 ²	10 ³	10 ⁴	10 ⁵	10 ⁶	10 ⁷	10 ⁻¹	10 ⁻²	10 ⁻³

NB For case size 0603 values other than E24 and E96 resistors will be supplied unmarked.

All resistors smaller than 0603 supplied unmarked.

Packaging

Packing Quantity and Reel Specification

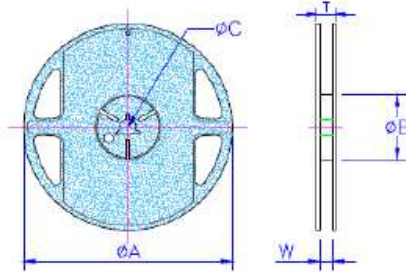

Size	$\varnothing A \pm 1.0$	$\varnothing B \pm 1.0$	$\varnothing C \pm 0.7$	$W \pm 1.0$	$T \pm 1.0$	Paper Tape	Embossed Plastic Tape	
0201	178.0	60.0	13.5	9.5	11.5	1000 / 10000	N/A	
0402								
0603								
0805				13.5	15.5	N/A		4000
1206								
1210								
2010								
2512								

Paper tape Specification

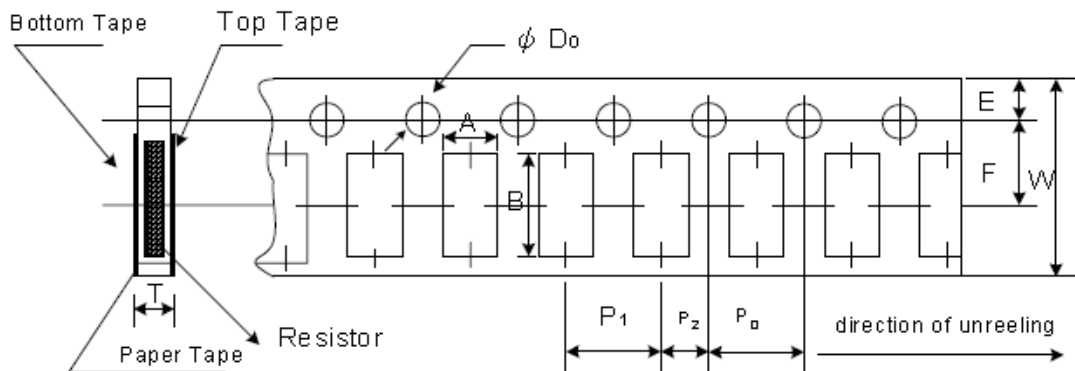

Size	$A \pm 0.05$	$B \pm 0.05$	$W \pm 0.10$	$E \pm 0.05$	$F \pm 0.05$	P_0	P_1	$P_2 \pm 0.05$	$\varnothing D_0$	T	
0201	0.40	0.70	8.00	1.75	3.5	4.00 ± 0.10	2.00 ± 0.05	2.00	1.55 ± 0.03	0.42 ± 0.02	
0402	0.70	1.16					4.00 ± 0.10		4.00 ± 0.10	1.55 ± 0.05	0.40 ± 0.03
0603	1.10	1.90					4.00 ± 0.05			1.55 ± 0.05	0.60 ± 0.03
0805	1.60	2.37				4.00 ± 0.05	1.60 ± 0.10	0.75 ± 0.05			
1206	2.00	3.55									
1210	2.75	3.40									

Peel force of top cover tape

The peel speed shall be about 300mm/min±5%

The peel force of top cover tape shall be between 8gf to 60gf



Embossed Plastic Tape Specifications



Type	A	B	W	E	F	P ₀	P ₁	P ₂	ØD ₀	T
2010	2.85±0.10	5.45±0.10	12.0±0.10	1.75±0.10	5.5±0.05	4.00±0.05	4.00±0.10	2.00±0.05	1.50±0.10	1.00±0.20
2512	3.40±0.10	6.65±0.10	12.0±0.10	1.75±0.10	5.5±0.05	4.00±0.05	4.00±0.10	2.00±0.05	1.50±0.10	1.00±0.20

Peel force of top cover tape

The peel speed shall be about 300mm/min±5%

The peel force of top cover tape shall be between 20gf to 80g

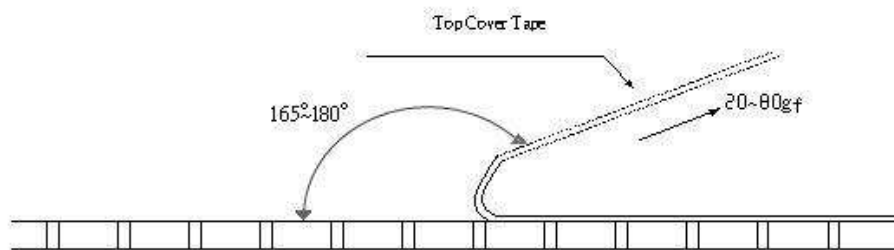

Reflow Solder Profile

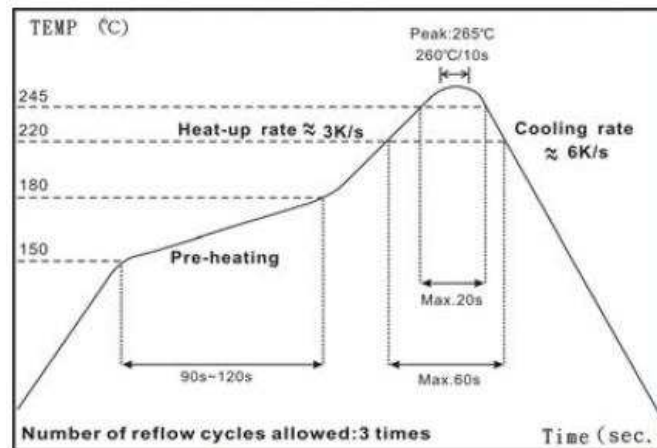

Time of Reflow soldering at maximum temperature point 260°C = 10s

Wave Solder Profile

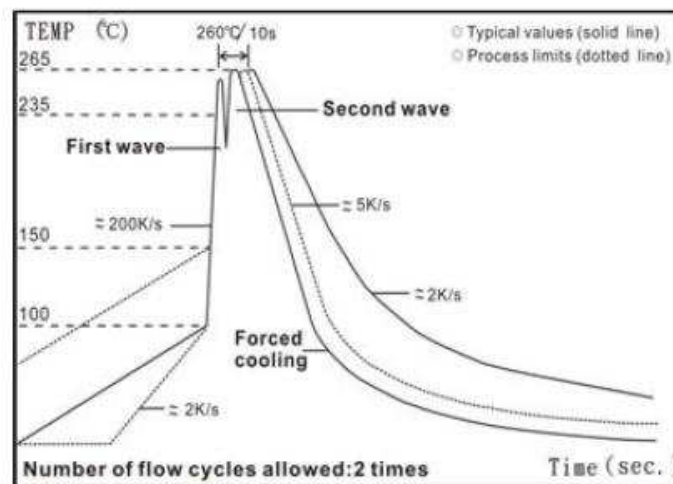

Time of Wave soldering at maximum temperature point 260°C = 10s

Time of Soldering Iron at maximum temperature point 410°C = 5s

How To Order

CPF	0603	B	100R	E	1
Common Part	Package Size	Tolerance	Value	TCR	Packaging
CPF - precision thin film chip resistor	0201 1206 0402 1210 0603 2010 0805 2512	B - $\pm 0.1\%$ D - $\pm 0.5\%$ F - $\pm 1\%$	100R - 100 Ω 1K Ω - 1000 Ω 10K - 10,000 Ω	D - 15PPM E - 25PPM C - 50PPM	1 - 1K REEL Blank - standard reel 0201 - 10K 0402 0603 0805 1206 1210 - 5K 2010 2512 - 4K

Mouser Electronics

Authorized Distributor

Click to View Pricing, Inventory, Delivery & Lifecycle Information:

[TE Connectivity:](#)

[CPF0201B4K12E1](#)