

REVISIONS

| P | LTR | DESCRIPTION | DATE | DWN | APVD |
|---|-----|-----------------|-----------|-----|------|
| | A | INITIAL RELEASE | 19JUN2020 | J.G | I.Y |
| | A1 | ECR-20-010349 | 26JUL2020 | J.G | I.Y |
| | | | | | |

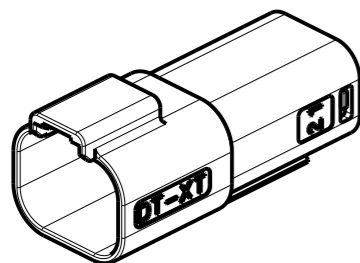

4CCT RECEPTACLE CONNECTOR WITHOUT HEATSHRINK HOUSING

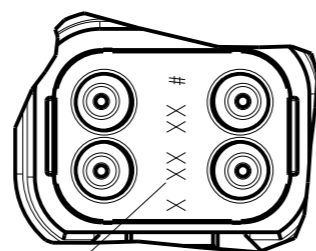

DETAIL A SCALE 2:1

4 DATE CODE: X XX XX
 X- DAY: 1- 7
 XX- WEEK: 01 - 52
 XX- YEAR: 00 - 99

#- MACHINE NO. 1

EXAMPLE: 11315 = DAY 1, WEEK 13, YEAR 15
i.e. 23rd OF MARCH 2015

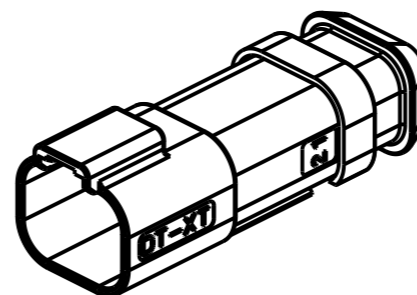

4CCT RECEPTACLE CONNECTOR WITH HEATSHRINK HOUSING ULTRASONICALLY WELDED IN PLACE

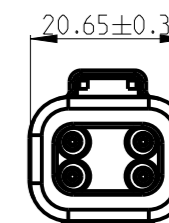
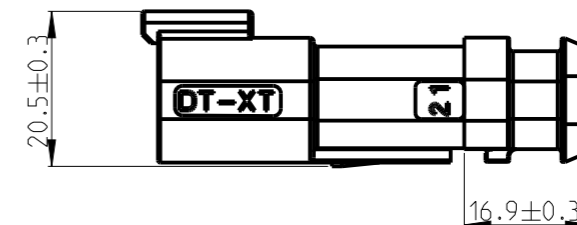
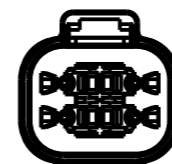
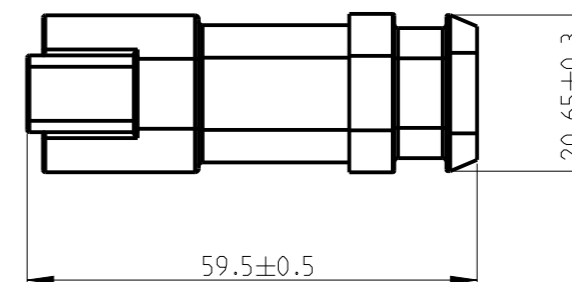
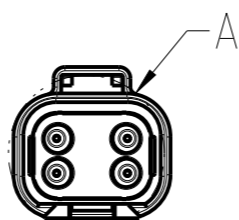
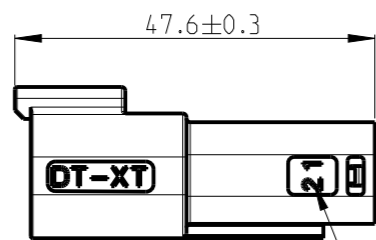
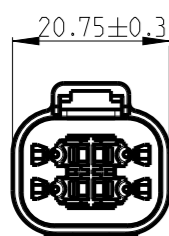

1. THIS RECEPT MATES WITH PLUG ASSEMBLY PN X-2600031-X.

2. MATERIALS

- RECEPTACLE HOUSING: NYLON GF30, SEE PN TABLE FOR COLOUR
- BACK SEAL: SILICONE RUBBER
- BACK COVER: NYLON GF30, BLACK
- HEATSHRINK HOUSING: NYLON GF30, BLACK

3 CIRCUIT IDENTIFICATION

4 DATE CODE DESCRIPTION

5. JACKET RANGE LARGE = Ø2.23MM TO 3.68MM (SEAL COLOUR: LIGHT BLUE)
JACKET RANGE SMALL = Ø1.20MM TO 3.05MM (SEAL COLOUR: BURNT ORANGE)

6. SEE SHEET 2 FOR FINAL PART NUMBER

THIS DRAWING IS A CONTROLLED DOCUMENT.

| DIMENSIONS: | TOLERANCES UNLESS OTHERWISE SPECIFIED: |
|-------------|--|
| mm | |
| | 0 PLC ± |
| | 1 PLC ± |
| | 2 PLC ± |
| | 3 PLC ± |
| | 4 PLC ± |
| | ANGLES ± |
| MATERIAL - | FINISH - |

| | | |
|------------------|------------|-----------|
| DWN | J.GU | 26JUL2020 |
| CHK | E. JIANG | 26JUL2020 |
| APVD | L. YIN | 26JUL2020 |
| PRODUCT SPEC | 108-160026 | |
| APPLICATION SPEC | 114-160017 | |
| WEIGHT | - | |

| | | | |
|--------------------------------------|-----------|--|---------------------|
| TE Connectivity | | NAME | |
| | | 4CCT DT-XT CONNECTOR RECEPTACLE ASSEMBLY | |
| SIZE | CAGE CODE | DRAWING NO | RESTRICTED TO |
| A3 | 00779 | ©=2600030 | - |
| CUSTOMER DRAWING;RESTRICTED CUSTOMER | | SCALE 1:1 | SHEET 1 OF 2 REV A1 |

THIS DRAWING IS UNPUBLISHED.

RELEASED FOR PUBLICATION

20

© COPYRIGHT 2020

TE Connectivity. All Rights Reserved.

ALL RIGHTS RESERVED.

REVISIONS

| P | LTR | DESCRIPTION | DATE | DWN | APVD |
|---|-----|-------------|------|-----|------|
| | | SEE SHEET 1 | | | |

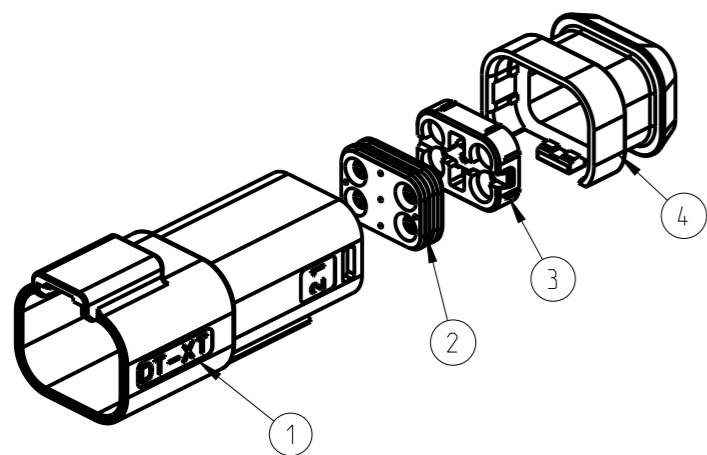

| TE PN | ALIAS PN | REVISION OF EACH ASSY NO. | WEIGHT OF EACH ASSY(g) | COLOR | BLACK | GERY | GREEN | BLUE | YELLOW | WHITE | BROWN | ORANGE | RED | BURNT ORANGE | LIGHT BLUE | BLACK | BLACK |
|-------|-----------|---------------------------|------------------------|-------|-------|------|-------|------|--------|-------|-------|--------|-----|--------------|------------|-------|-------|
| 3--6 | 934443609 | - | 10.02 | | - | - | - | - | - | - | - | - | 1 | - | 1 | 1 | 1 |
| 3--5 | 934443608 | - | 10.02 | | - | - | - | - | - | - | - | 1 | - | - | 1 | 1 | 1 |
| 3--4 | 934443607 | - | 10.02 | | - | - | - | - | - | 1 | - | - | - | - | 1 | 1 | 1 |
| 3--3 | 934443606 | - | 10.02 | | - | - | - | - | - | 1 | - | - | - | - | 1 | 1 | 1 |
| 3--2 | 934443605 | - | 10.02 | | - | - | - | - | 1 | - | - | - | - | - | 1 | 1 | 1 |
| 3--1 | 934443604 | - | 10.02 | | - | - | - | 1 | - | - | - | - | - | - | 1 | 1 | 1 |
| 3--0 | 934443603 | - | 10.02 | | - | - | - | - | 1 | - | - | - | - | - | 1 | 1 | 1 |
| 2--9 | 934443602 | - | 10.02 | | - | 1 | - | - | - | - | - | - | - | - | 1 | 1 | 1 |
| 2--8 | 934443601 | - | 10.02 | | - | - | - | - | - | - | - | - | - | - | 1 | 1 | 1 |
| 2--7 | 934443509 | - | 10.02 | | 1 | - | - | - | - | - | - | - | - | - | 1 | 1 | 1 |
| 2--6 | 934443508 | - | 10.02 | | - | - | - | - | - | - | - | 1 | - | 1 | - | 1 | 1 |
| 2--5 | 934443507 | - | 10.02 | | - | - | - | - | - | - | 1 | - | - | 1 | - | 1 | 1 |
| 2--4 | 934443506 | - | 10.02 | | - | - | - | - | - | 1 | - | - | - | 1 | - | 1 | 1 |
| 2--3 | 934443505 | - | 10.02 | | - | - | - | - | 1 | - | - | - | - | 1 | - | 1 | 1 |
| 2--2 | 934443504 | - | 10.02 | | - | - | - | 1 | - | - | - | - | - | 1 | - | 1 | 1 |
| 2--1 | 934443503 | - | 10.02 | | - | - | 1 | - | - | - | - | - | - | 1 | - | 1 | 1 |
| 2--0 | 934443502 | - | 10.02 | | - | 1 | - | - | - | - | - | - | - | 1 | - | 1 | 1 |
| 1--9 | 934443501 | - | 10.02 | | 1 | - | - | - | - | - | - | - | - | 1 | - | 1 | 1 |
| 1--8 | 934443209 | - | 7.61 | | - | - | - | - | - | - | - | 1 | - | 1 | - | 1 | - |
| 1--7 | 934443208 | - | 7.61 | | - | - | - | - | - | - | 1 | - | - | 1 | - | 1 | - |
| 1--6 | 934443207 | - | 7.61 | | - | - | - | - | - | 1 | - | - | - | 1 | - | 1 | - |
| 1--5 | 934443206 | - | 7.61 | | - | - | - | - | 1 | - | - | - | - | 1 | - | 1 | - |
| 1--4 | 934443205 | - | 7.61 | | - | - | - | 1 | - | - | - | - | - | 1 | - | 1 | - |
| 1--3 | 934443204 | - | 7.61 | | - | - | - | 1 | - | - | - | - | - | 1 | - | 1 | - |
| 1--2 | 934443203 | - | 7.61 | | - | - | 1 | - | - | - | - | - | - | 1 | - | 1 | - |
| 1--1 | 934443202 | - | 7.61 | | - | 1 | - | - | - | - | - | - | - | 1 | - | 1 | - |
| 1--0 | 934443201 | - | 7.61 | | 1 | - | - | - | - | - | - | - | - | 1 | - | 1 | - |
| -9 | 934443109 | - | 7.61 | | - | - | - | - | - | - | - | 1 | 1 | - | - | 1 | - |
| -8 | 934443108 | - | 7.61 | | - | - | - | - | - | - | - | 1 | - | 1 | - | 1 | - |
| -7 | 934443107 | - | 7.61 | | - | - | - | - | - | 1 | - | - | - | 1 | - | 1 | - |
| -6 | 934443106 | - | 7.61 | | - | - | - | - | 1 | - | - | - | - | 1 | - | 1 | - |
| -5 | 934443105 | - | 7.61 | | - | - | - | - | 1 | - | - | - | - | 1 | - | 1 | - |
| -4 | 934443104 | - | 7.61 | | - | - | - | 1 | - | - | - | - | - | 1 | - | 1 | - |
| -3 | 934443103 | - | 7.61 | | - | - | 1 | - | - | - | - | - | - | 1 | - | 1 | - |
| -2 | 934443102 | - | 7.61 | | - | 1 | - | - | - | - | - | - | - | 1 | - | 1 | - |
| -1 | 934443101 | - | 7.61 | | 1 | - | - | - | - | - | - | - | - | 1 | - | 1 | - |

QTY. REQUEST PER ASSY

THIS DRAWING IS A CONTROLLED DOCUMENT.

| | |
|-------------|--|
| DIMENSIONS: | TOLERANCES UNLESS OTHERWISE SPECIFIED: |
| mm | 0 PLC ± |
| | 1 PLC ± |
| | 2 PLC ± |
| | 3 PLC ± |
| | 4 PLC ± |
| | ANGLES ± |

| | |
|----------|--------|
| MATERIAL | FINISH |
| - | - |

| | | |
|------------------|------------|-----------|
| DWN | J.GU | 26JUL2020 |
| CHK | E. JIANG | 26JUL2020 |
| APVD | L. YIN | 26JUL2020 |
| PRODUCT SPEC | 108-160026 | |
| APPLICATION SPEC | 114-160017 | |
| WEIGHT | - | |

TE TE Connectivity

NAME: 4CCT DT-XT CONNECTOR RECEPTACLE ASSEMBLY

| | | | |
|------|-----------|------------|---------------|
| SIZE | CAGE CODE | DRAWING NO | RESTRICTED TO |
| A3 | 00779 | C=2600030 | - |

CUSTOMER DRAWING; RESTRICTED CUSTOMER SCALE 1:1 SHEET 2 OF 2 REV A1

Mouser Electronics

Authorized Distributor

Click to View Pricing, Inventory, Delivery & Lifecycle Information:

[TE Connectivity:](#)

[934443501](#)