

REVISIONS					
P	LTR	DESCRIPTION	DATE	DWN	APVD
E		REVISED	09APR2021	M.T	H.T

- NOTE
- ① HOUSING AND COVER: LCP, UL94-V0, BLACK.
CONTACTS: COPPER ALLOY.
 - ② GOLD PLATE ON CONTACT AREA.
TIN PLATE ON SOLDER TAIL AREA.
 - ③ APPLICABLE HOST BOARD THICKNESS
 - ④ OFFSET AMOUNT BETWEEN AIC BOARD AND HOST BOARD CENTER LINE.
 - ⑤ SEE MSA SPECIFICATION FOR ADDITIONAL PADDLE CARD LAYOUTS COMPATIBLE WITH THIS RECEPTACLE AND FOR OPTIONAL SPLIT CONTACT PAD LAYOUTS FOR THE PADDLE CARD. SPECIFICATION PINOUT MAY ALSO DESIGNATE PAD SEQUENCE DIFFERENT FROM ILLUSTRATION.
 - ⑥ POSITIONS DESIGNATED AS "SIGNAL" ARE RECOMMENDED LOCATIONS FOR HIGH SPEED DIFFERENTIAL PAIR SIGNALING. THESE LOCATIONS MAY ALSO BE USED FOR SUPPORTING SIDEBAND SIGNALS OR OTHER UTILITY PURPOSES. POSITIONS DESIGNATED AS "GROUND" ARE REQUIRED WHEN SUPPORTING HIGH SPEED DIFFERENTIAL SIGNALS. THESE LOCATIONS MAY ALSO BE USED FOR SIDEBAND SIGNALS OR OTHER UTILITY PURPOSES.
 - ⑦ CONTROLLED ACROSS PADS.
 - ⑧ THIS LAYOUT IS ADOPTED IN SFF-TA-1002
 - ⑨ SCREW IS ENCLOSED BY SEPARATE PACKING.
SCREW SIZE: M2
SCREW LENGTH(REF): 6
HEAD SIZE(REF): Ø3.5, 1.3HEIGHT
 - ⑩ DATE CODE MARKING.
 - ⑪ CONNECTOR MUST BE FIXED ON PCB BY SCREW AFTER SOLDERING.
 - ⑫ ALL CHAMFERED EDGES AND EDGE OF PADS SHALL BE FREE OF BURRS.
 - ⑬ HOUSING ID MARK

PLATING	PACKAGING	SCREW INCLUSION	④ DIM A	③ DIM B (HOST BOARD THICKNESS)	PARTS No.
0.76 μm Au	SOFT TRAY	YES	0	1.57 ±0.15	2340324-1
		NO	0	1.57 ±0.15	2340324-3
		YES	0.3	1.93 ±0.19	1-2340324-2
		YES	0	2.36 ±0.23	2-2340324-1
		NO	0	2.36 ±0.23	2-2340324-3
		YES	0	2.55 ^{+0.23} , 2.6 ^{+0.23}	4-2340324-1
	HARD TRAY	YES	0	1.57 ±0.15	5-2340324-1
		NO	0	1.57 ±0.15	5-2340324-3
		YES	0.3	1.93 ±0.19	6-2340324-2
		NO	0.3	1.93 ±0.19	6-2340324-4
		YES	0	2.36 ±0.23	7-2340324-1
		NO	0	2.36 ±0.23	7-2340324-3
		YES	0	2.55 ^{+0.23} , 2.6 ^{+0.23}	9-2340324-1

AS SHOWN : -1, -3, 1--2, 2--1, 2--3, 4--1, 5--1, 5--3, 6--2, 6--4, 7--1, 7--3, 9--1

QTY	NAME	ITEM No.
2	M2 SCREW	②
2	M2 NUT PLATE	⑤
4	COVER HOUSING 28P	④
2	COVER HOUSING 14P	③
1	HOUSING	①
140	CONTACT	①

THIS DRAWING IS A CONTROLLED DOCUMENT.

DWN: M.TANAKA CHK: J.TSUJI APVD: K.KOBAYASHI	30JUL2018 30JUL2018 30JUL2018	 TE Connectivity Ltd.
NAME: 108-140197 APPLICATION SPEC: 114-78033	NAME: 140 POSITION SLIVER 2.0 STRADDLE MOUNT	
MATERIAL:	FINISH:	SIZE: A2 CAGE CODE: 00779 DRAWING NO: C=2340324 RESTRICTED TO: <input type="checkbox"/>
CUSTOMER DRAWING		SCALE: 4:1 SHEET: 1 of 5 REV: E

2340324

REVISIONS					
P	LTR	DESCRIPTION	DATE	DWN	APVD
-	-	SEE SHEET 1	-	-	-

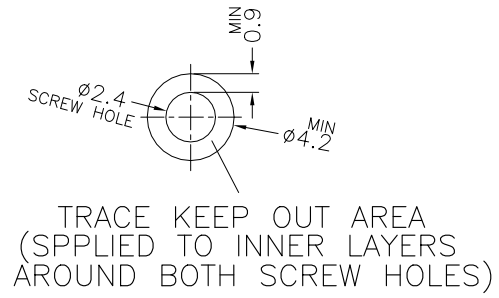
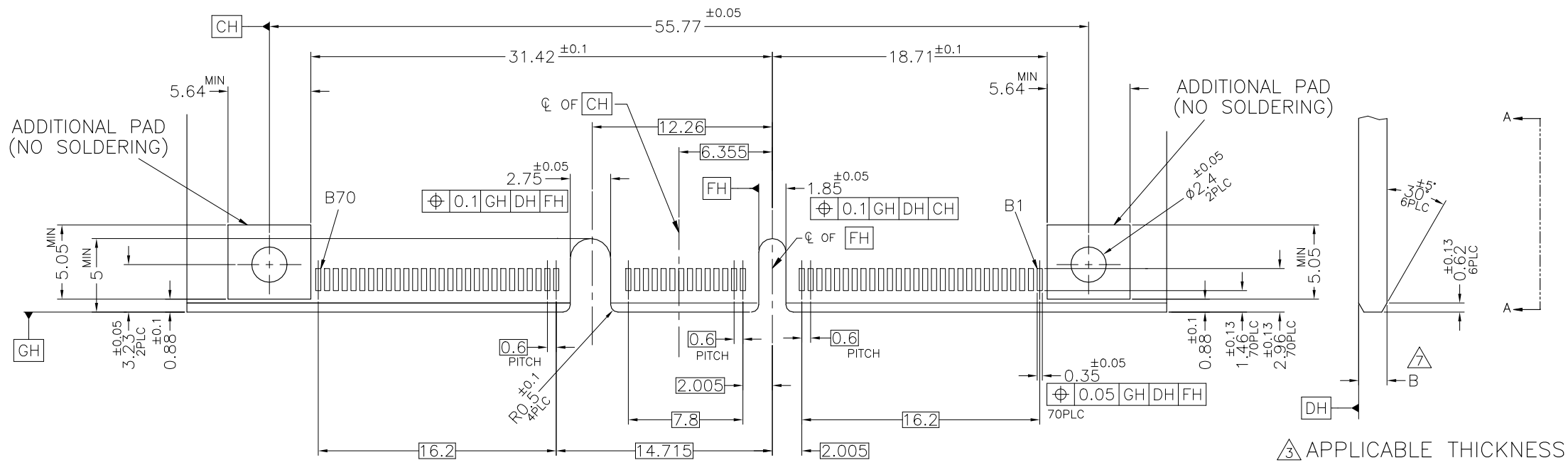

REFERENCE HOST BOARD LAYOUT

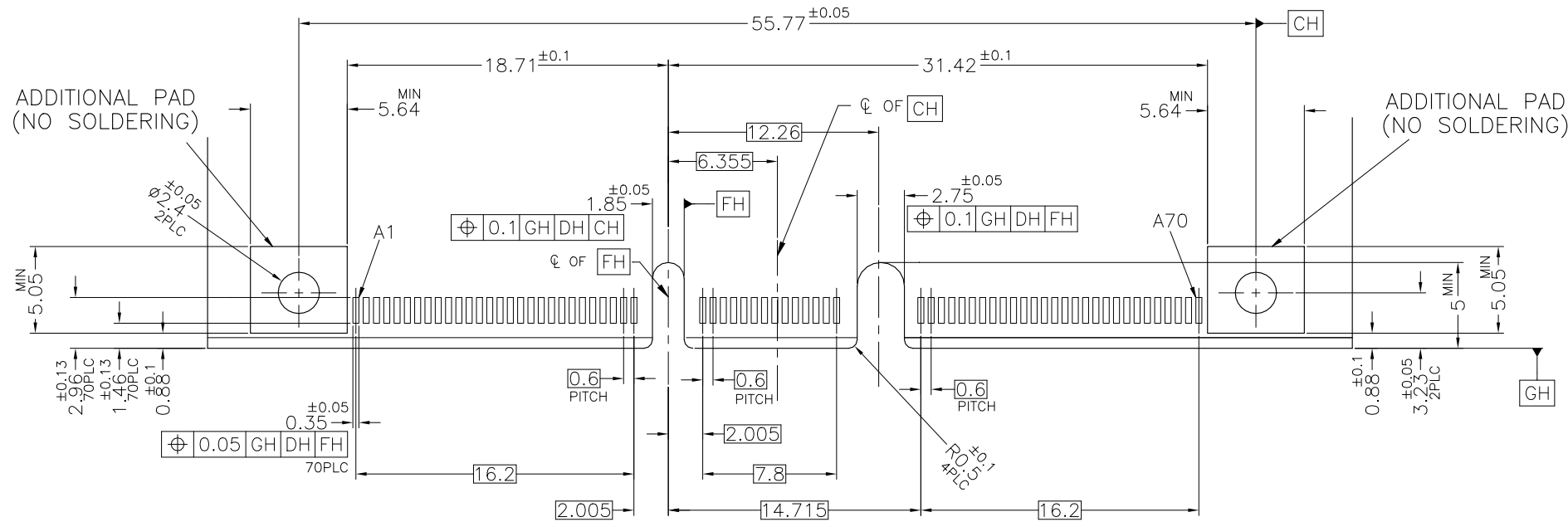

VIEW A-A

HOST BOARD LAYOUT

THIS DRAWING IS A CONTROLLED DOCUMENT.		DWN	TE Connectivity Ltd.		
DIMENSIONS: mm		CHK	NAME		
TOLERANCES UNLESS OTHERWISE SPECIFIED: ±0.3		APVD	140 POSITION SLIVER 2.0 STRADDLE MOUNT		
<ul style="list-style-type: none"> Ø-PLC ± +PLC ± 2-PLC ± 3-PLC ± 4-PLC ± ANGLES ± FINISH 		PRODUCT SPEC	SIZE	CAGE CODE	DRAWING NO
MATERIAL		APPLICATION SPEC	A2	00779	C=2340324
		WEIGHT	RESTRICTED TO		
		CUSTOMER DRAWING	SCALE	SHEET	REV
			4:1	2 of 5	E

REVISIONS

P	LTR	DESCRIPTION	DATE	DWN	APVD
-	-	SEE SHEET 1	-	-	-

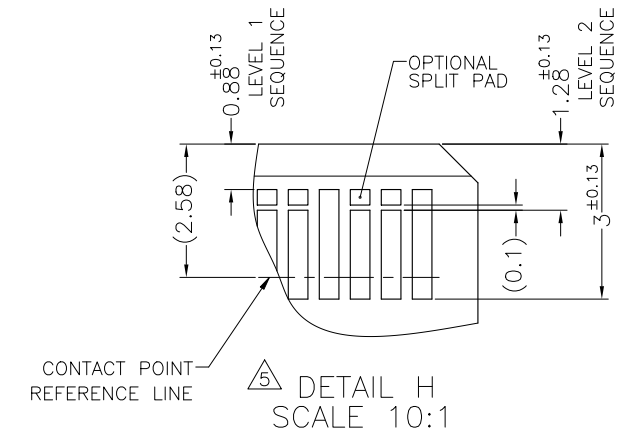
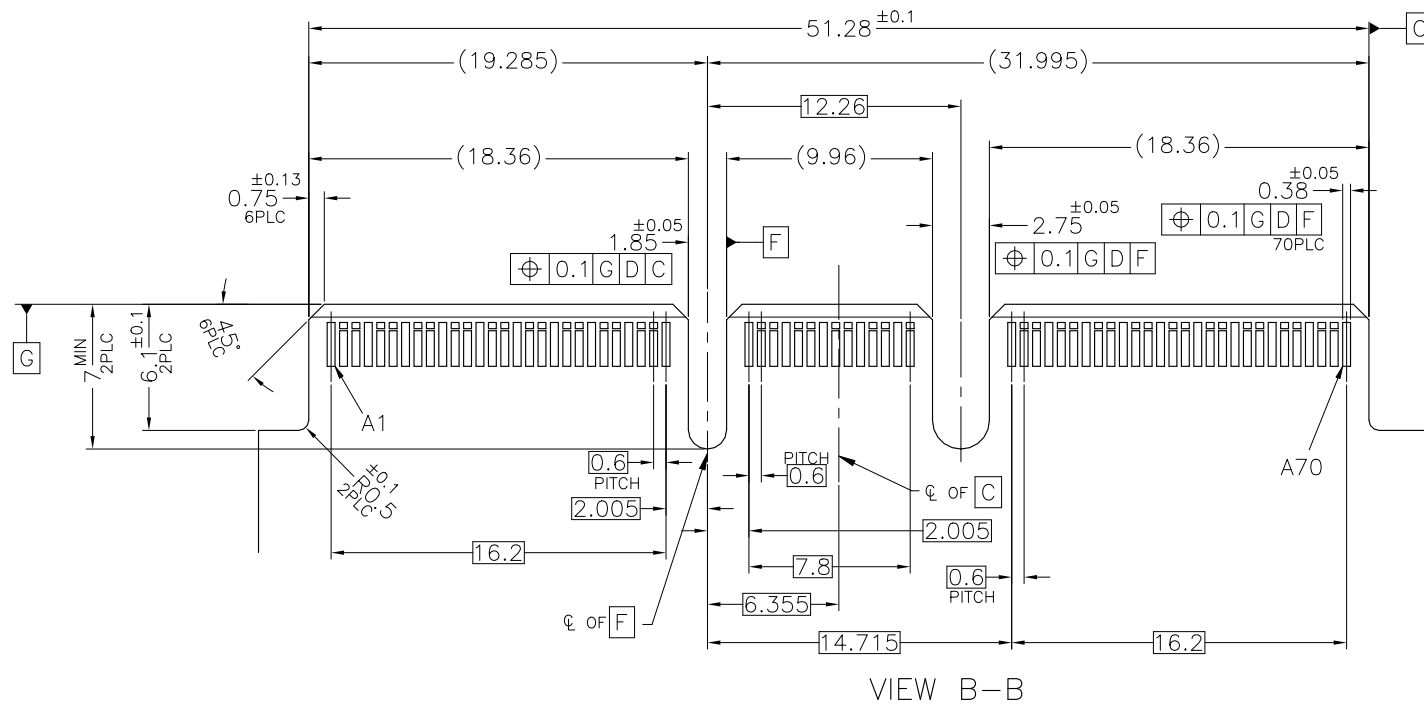
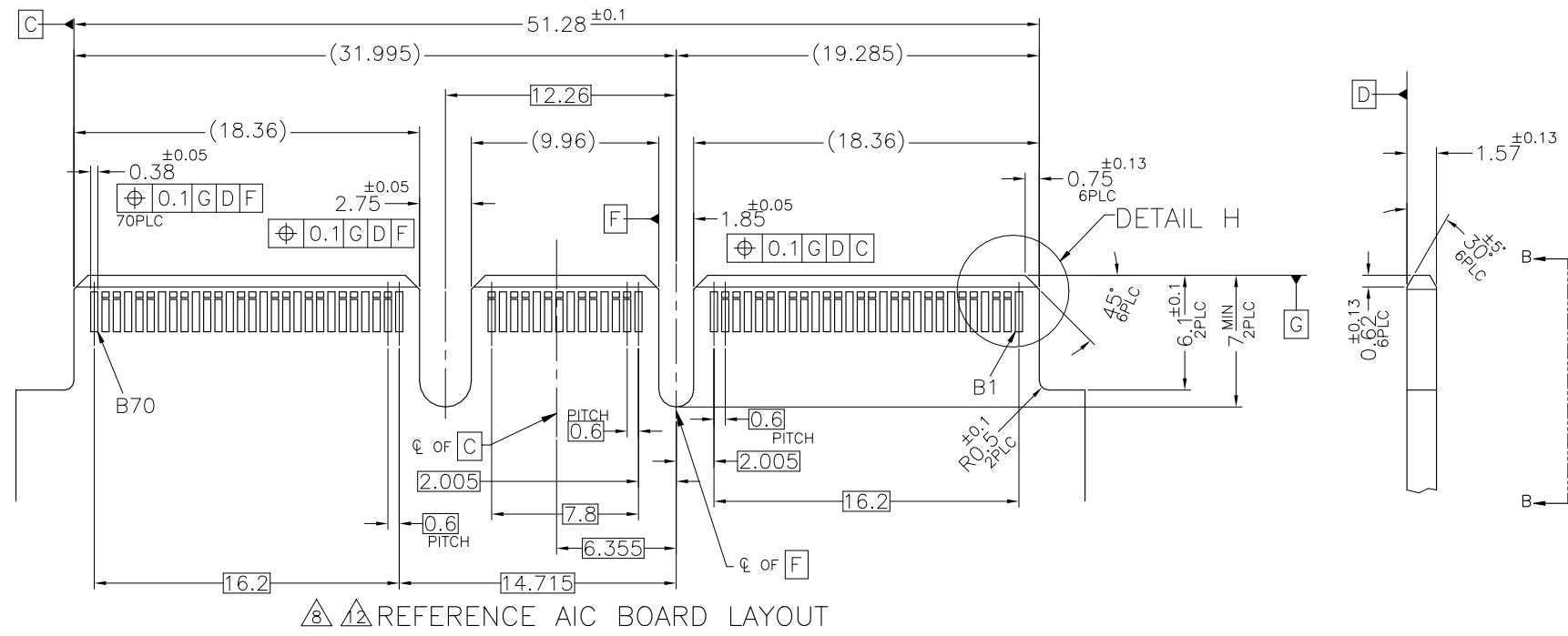

THIS DRAWING IS A CONTROLLED DOCUMENT.		DWN	TE Connectivity Ltd.		
DIMENSIONS: mm		CHK	NAME		
TOLERANCES UNLESS OTHERWISE SPECIFIED: ±0.3		APVD	140 POSITION SLIVER 2.0 STRADDLE MOUNT		
<ul style="list-style-type: none"> 6-PLC ± 4-PLC ± 2-PLC ± 3-PLC ± 4-PLC ± 		PRODUCT SPEC	SIZE	CAGE CODE	DRAWING NO
MATERIAL		APPLICATION SPEC	A2	00779	C=2340324
FINISH		WEIGHT	CUSTOMER DRAWING		RESTRICTED TO
		SCALE	4:1	SHEET	3 of 5
		REV	E		

REVISIONS					
P	LTR	DESCRIPTION	DATE	DWN	APVD
-	-	SEE SHEET 1	-	-	-

CONNECTOR CONTACT IDENTIFICATION

CONTACT NUMBER	SIDE A	SIDE B
1	GROUND	GROUND
2	SIGNAL	SIGNAL
3	SIGNAL	SIGNAL
4	GROUND	GROUND
5	SIGNAL	SIGNAL
6	SIGNAL	SIGNAL
7	GROUND	GROUND
8	SIGNAL	SIGNAL
9	SIGNAL	SIGNAL
10	GROUND	GROUND
11	SIGNAL	SIGNAL
12	SIGNAL	SIGNAL
13	GROUND	GROUND
14	SIGNAL	SIGNAL
15	SIGNAL	SIGNAL
16	GROUND	GROUND
17	SIGNAL	SIGNAL
18	SIGNAL	SIGNAL
19	GROUND	GROUND
20	SIGNAL	SIGNAL
21	SIGNAL	SIGNAL
22	GROUND	GROUND
23	SIGNAL	SIGNAL
24	SIGNAL	SIGNAL
25	GROUND	GROUND
26	SIGNAL	SIGNAL
27	SIGNAL	SIGNAL
28	GROUND	GROUND
29	GROUND	GROUND
30	SIGNAL	SIGNAL
31	SIGNAL	SIGNAL
32	GROUND	GROUND
33	SIGNAL	SIGNAL
34	SIGNAL	SIGNAL
35	GROUND	GROUND

CONTACT NUMBER	SIDE A	SIDE B
36	SIGNAL	SIGNAL
37	SIGNAL	SIGNAL
38	GROUND	GROUND
39	SIGNAL	SIGNAL
40	SIGNAL	SIGNAL
41	GROUND	GROUND
42	GROUND	GROUND
43	GROUND	GROUND
44	SIGNAL	SIGNAL
45	SIGNAL	SIGNAL
46	GROUND	GROUND
47	SIGNAL	SIGNAL
48	SIGNAL	SIGNAL
49	GROUND	GROUND
50	SIGNAL	SIGNAL
51	SIGNAL	SIGNAL
52	GROUND	GROUND
53	SIGNAL	SIGNAL
54	SIGNAL	SIGNAL
55	GROUND	GROUND
56	SIGNAL	SIGNAL
57	SIGNAL	SIGNAL
58	GROUND	GROUND
59	SIGNAL	SIGNAL
60	SIGNAL	SIGNAL
61	GROUND	GROUND
62	SIGNAL	SIGNAL
63	SIGNAL	SIGNAL
64	GROUND	GROUND
65	SIGNAL	SIGNAL
66	SIGNAL	SIGNAL
67	GROUND	GROUND
68	SIGNAL	SIGNAL
69	SIGNAL	SIGNAL
70	GROUND	GROUND

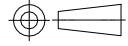
THIS DRAWING IS A CONTROLLED DOCUMENT.		DWN	 TE Connectivity Ltd.		
DIMENSIONS: mm		CHK	NAME		
		APVD	140 POSITION SLIVER 2.0 STRADDLE MOUNT		
TOLERANCES UNLESS OTHERWISE SPECIFIED:		PRODUCT SPEC	SIZE	CAGE CODE	DRAWING NO
0-PLG ± 1-PLG ± 2-PLG ± 3-PLG ± 4-PLG ± ANGLES ± FINISH ±		APPLICATION SPEC	A2	00779	C=2340324
MATERIAL	WEIGHT	RESTRICTED TO			
	CUSTOMER DRAWING	SCALE	NTS	SHEET	4 of 5
		REV	E		

4

3

2

1

REVISIONS					
P	LTR	DESCRIPTION	DATE	DWN	APVD
-	-	SEE SHEET 1	-	-	-

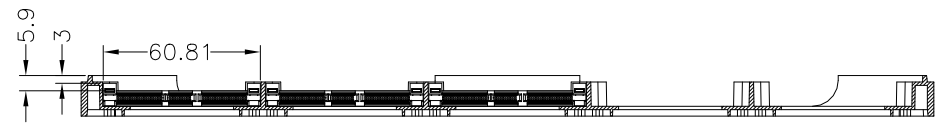
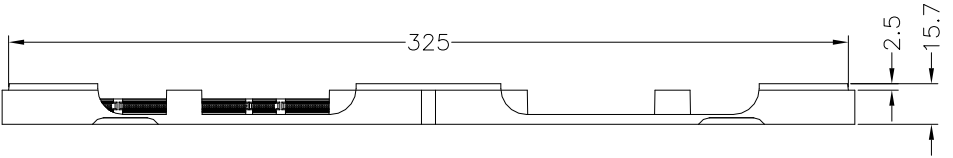
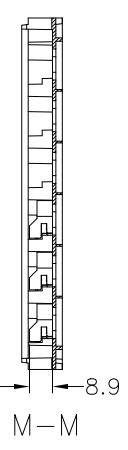
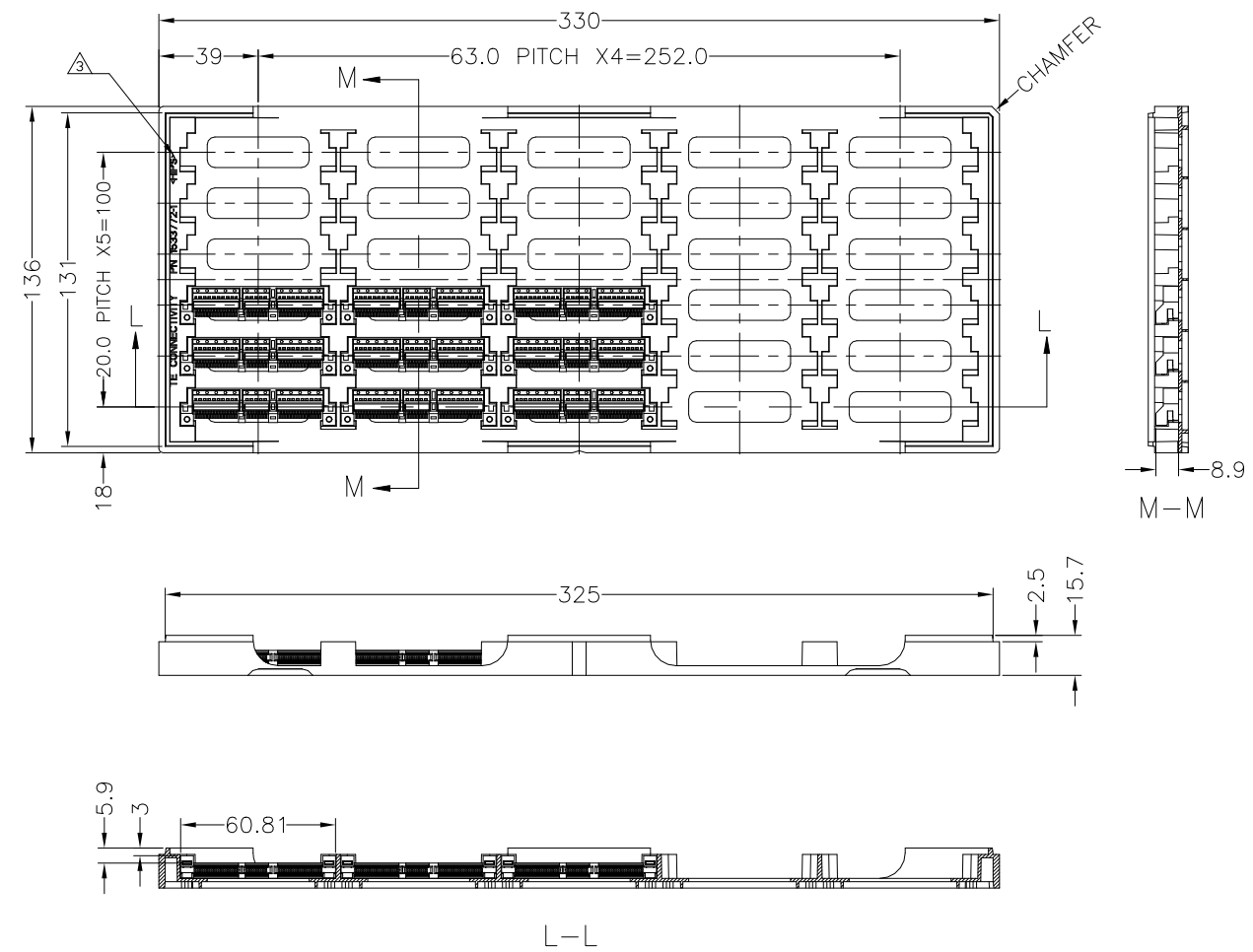
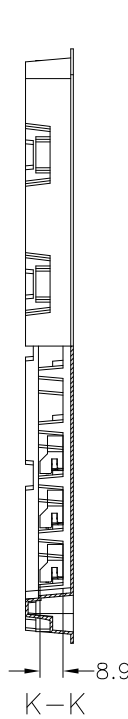
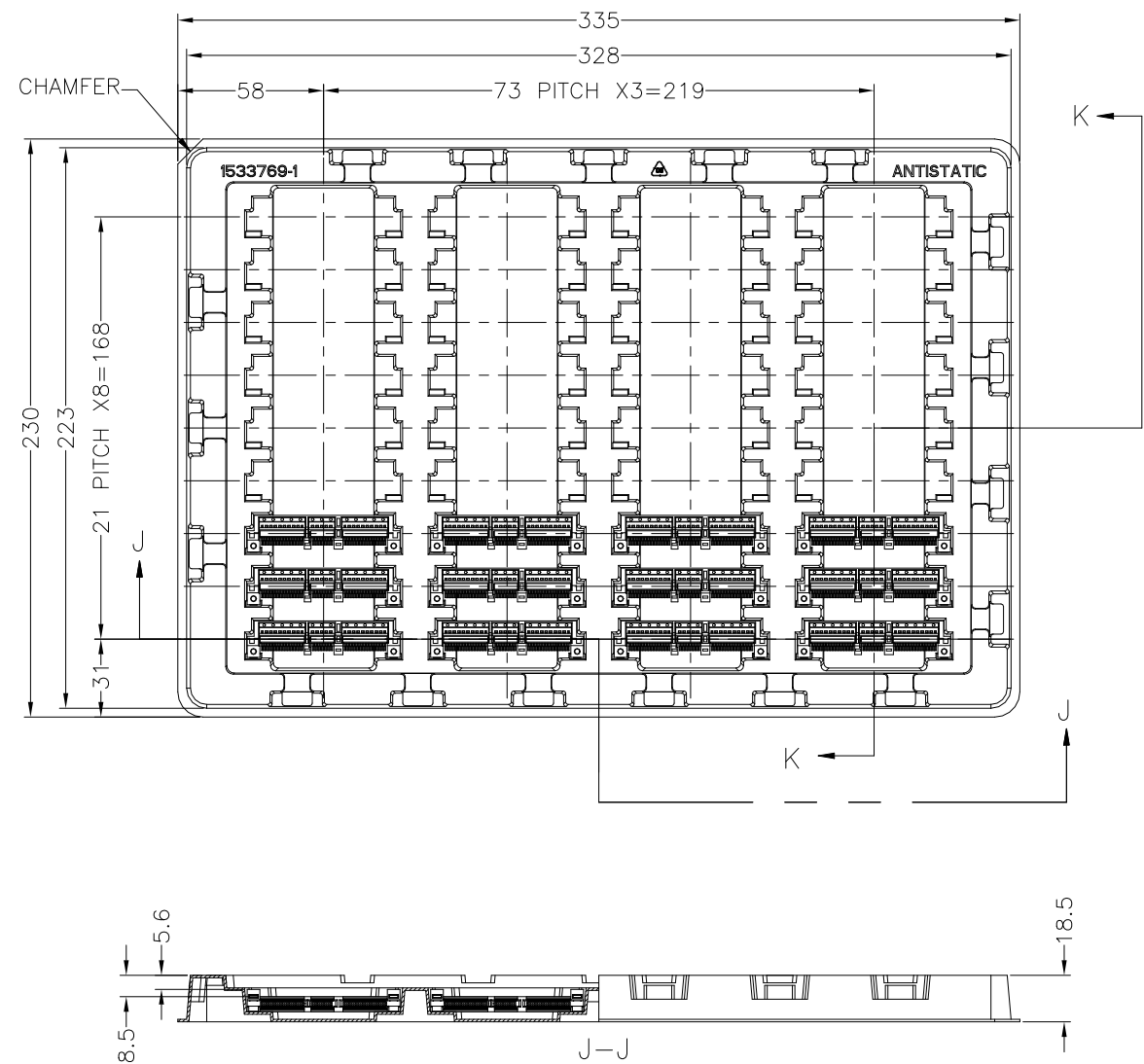

SOFT TRAY PACKAGING: -1, -3, 1--2, 2--1, 2--3, 4--1

1. MATERIAL: HIPS, COLOR: NATURAL
2. QTY. : 9 X 4 = 36 POCKETS PER TRAY
3. TOLERANCES ON TRAY DIMENSIONS ARE REFERENCE

HARD TRAY PACKAGING: 5--1, 6--2, 7--1
5--3, 6--4, 7--3, 9--1

1. MATERIAL: HIPS, COLOR: BLACK
2. QTY. : 6 X 5 = 30 POCKETS PER TRAY
3. MARKING
4. TOLERANCES ON TRAY DIMENSIONS ARE REFERENCE

THIS DRAWING IS A CONTROLLED DOCUMENT.		DWN	TE Connectivity Ltd.		
DIMENSIONS: mm		CHK	NAME		
TOLERANCES UNLESS OTHERWISE SPECIFIED:		APVD	140 POSITION SLIVER 2.0 STRADDLE MOUNT		
0-PLG ±		PRODUCT SPEC	SIZE	CAGE CODE	DRAWING NO
+PLG ±		APPLICATION SPEC	A2	00779	C=2340324
2-PLG ±		WEIGHT	RESTRICTED TO		
3-PLG ±		CUSTOMER DRAWING	SCALE NTS SHEET 5 of 5 REV E		
4-PLG ±					
ANGLES ±					
FINISH					

Mouser Electronics

Authorized Distributor

Click to View Pricing, Inventory, Delivery & Lifecycle Information:

[TE Connectivity:](#)

[6-2340324-2](#)