

P	LTR	DESCRIPTION	DATE	DWN	APVD
	3	REVISED DRAWING	13NOV2019	MZ	MZ
	4	REVISED DRAWING	15SEP2020	FD	PO
	A	ECR-21-001958	02MAR2021	SR	FD
	B	REVISED PER ECR-21-108141	20JUL2021	SM	FD

NOTES:

DIMENSIONS BEFORE APPLICATION

1 MATERIALS:
 CONTACT : COPPER ALLOY, TIN PLATED
 HOUSING: PPE+PS; COLOR: DARK GREY
 BUTTON: PPE+PS; COLOR: DARK GREY

2. APPLICABLE CABLES:

A) APPROVED ACCORDING UL FILE E13288 FOR SOLAR CABLES FROM 5.5 mm TO 7.2 mm

B) UNDER APPROVAL BY IEC62852 FOR FOLLOWING CABLE TYPES FROM DEFINED MANUFACTURERS:

- TE CABLE PN 2328394, 2.5 mm² (14 AWG)
- TE CABLE PN 2270245, 4 mm² (12 AWG)
- TE CABLE PN 2270260, 4 mm² (12 AWG)
- TE CABLE PN 2328400, 6 mm² (10 AWG)
- TE CABLE PN 2270215, 4 mm² (12 AWG)
- TE CABLE PN 2270259, 4 mm² (12 AWG)

BYSON 6351D 2.5mm²/14AWG

BYSON 6352D 4mm²/12AWG

BYSON 6353D 6mm²/10AWG

HONGLIN DPN4012A20 4mm²/12AWG

3 MOULDING PRODUCTION DATE MARKING

4 AREA FOR LASER PRINT DATA MATRIX AND PARTNUMBER

PPPPPPPPVYYWDFL#####

- P P P P P P P P = PART NUMBER
- V = VERSION CUSTOMER DRAWING
- Y Y = LAST TWO DIGITS OF YEAR 19
- W W = WEEK NUMBER
- D = WEEKDAY (1 MONDAY)
- F = FACTORY CODE (S = SZCZECIN, T = TRUTNOV)
- L = MANUFACTURING LINE (M=MANUAL, A=AUTOMATIC)
- ##### = SERIAL NUMBER (PRODUCTION PER DAY)

5 CABLE FOR REFERENCE ONLY

6 NOTE REMOVED

7 WHEN BUTTON AND HOUSING RIBS ARE ALIGNED, THE CONNECTOR IS CORRECTLY TERMINATED

8 MINIMUM CABLE INSERTION LENGTH 53.8 mm ± 2 mm



9. CHECK APPLICATION SPEC 114-133104 FOR PROPER CABLE CONNECTION

10. FOR PACKAGING FORMAT AND QUANTITY SEE 107-133104.

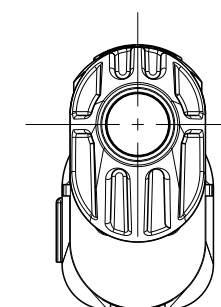
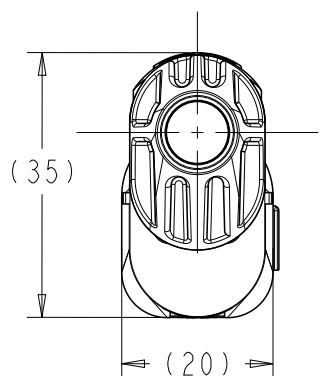
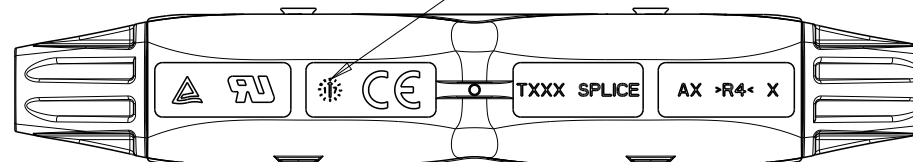
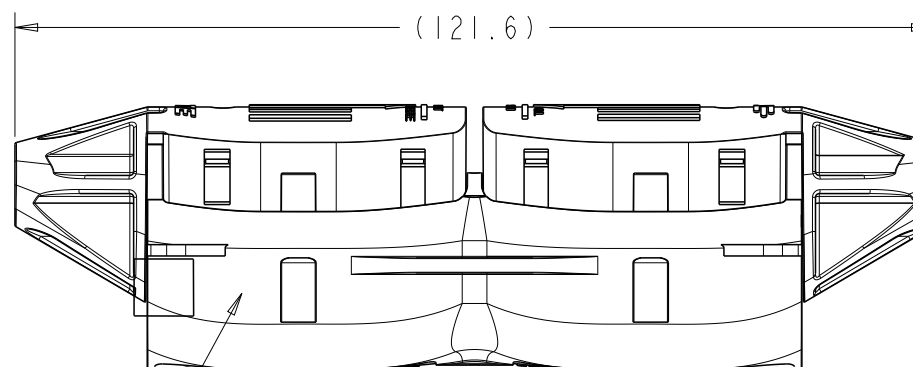
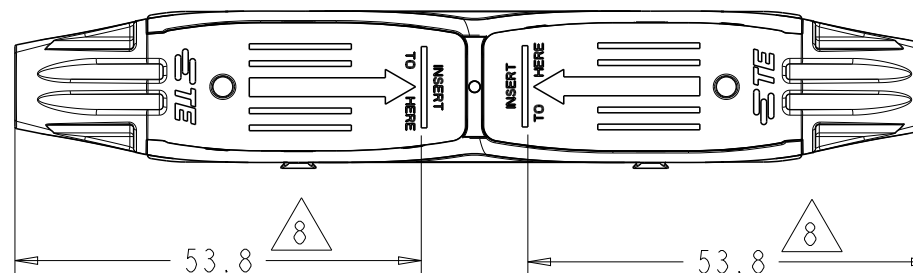
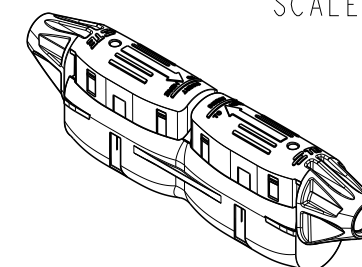
SCALE 1:2

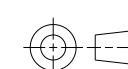

P/N 2336077-1 AS SHOWN
MODEL CODE: SLK-ID-1-BL-XX

THIS DRAWING IS A CONTROLLED DOCUMENT.		DWN	29JUN2018		 TE Connectivity
		CHK	29JUN2018		
		APVD	29JUN2018		
		PRODUCT SPEC	108-133104		
DIMENSIONS:		TOLERANCES UNLESS OTHERWISE SPECIFIED:		NAME	
mm				SOLARLOK 2.0 - SPLICE	
		0 PLC ±0.4 1 PLC ±0.3 2 PLC ± 3 PLC ± 4 PLC ± ANGLES ± FINISH -		APPLICATION SPEC	
MATERIAL				114-133104	
				WEIGHT 48.4 gr	
		CUSTOMER DRAWING		SIZE A3	CAGE CODE 00779
				DRAWING NO C-2336077	
				RESTRICTED TO	-
				SCALE 1:1	SHEET 1 OF 3
				REV B	

THIS DRAWING IS UNPUBLISHED.

RELEASED FOR PUBLICATION

20

© COPYRIGHT 20 BY -

ALL RIGHTS RESERVED.

REVISIONS

P	LTR	DESCRIPTION	DATE	DWN	APVD
-	-	SEE SHEET 1	-	-	-

DIMENSIONS AFTER APPLICATION

SCALE 1:2

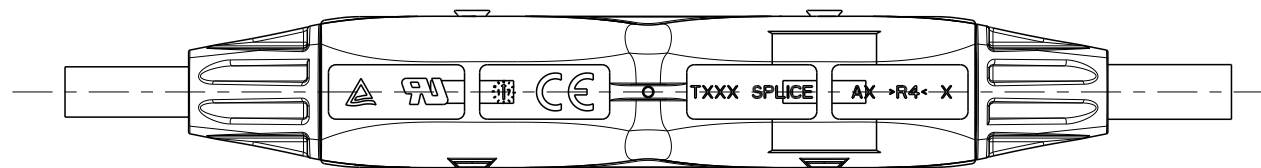
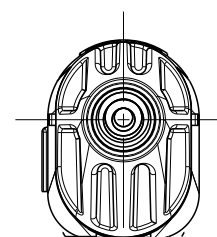
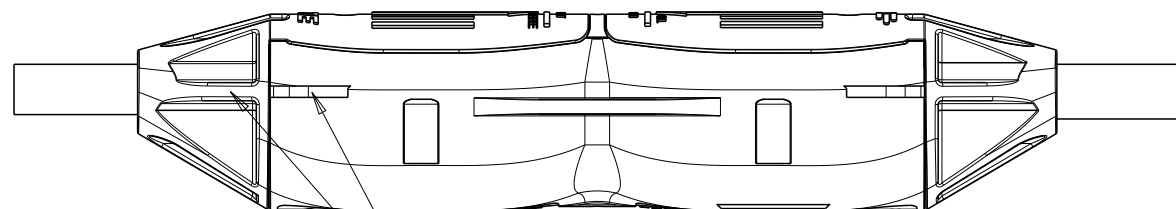
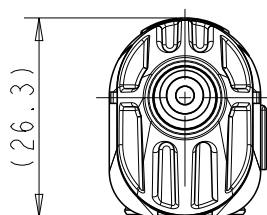
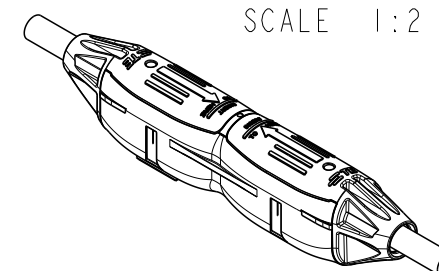
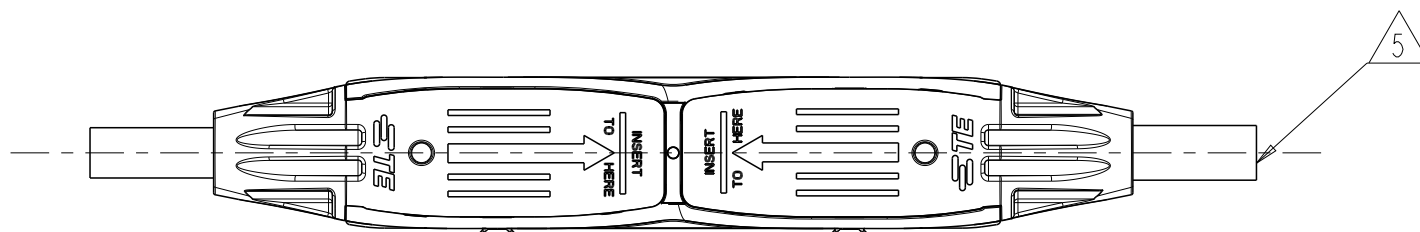

THIS DRAWING IS A CONTROLLED DOCUMENT.

DIMENSIONS: mm	TOLERANCES UNLESS OTHERWISE SPECIFIED:
	0 PLC ±0.4
	1 PLC ±0.3
	2 PLC ±-
	3 PLC ±-
	4 PLC ±-
	ANGLES ±-
MATERIAL	FINISH
	-

DWN	29JUN2018
GANESH C M	
CHK	29JUN2018
D FREDDY	
APVD	29JUN2018
D FREDDY	
PRODUCT SPEC	108-133104
APPLICATION SPEC	114-133104
WEIGHT	-
CUSTOMER DRAWING	



NAME			
SOLARLOK 2.0 - SPLICE			
SIZE	CAGE CODE	DRAWING NO	RESTRICTED TO
A3	00779	C-2336077	-
SCALE		SHEET	REV
5:1		2 OF 3	B

REVISIONS

P	LTR	DESCRIPTION	DATE	DWN	APVD
-	-	SEE SHEET 1	-	-	-

DIMENSIONS AFTER STACKING

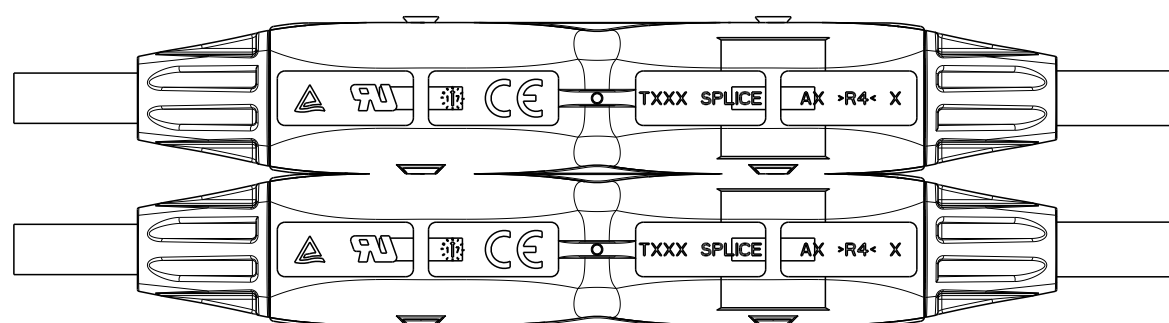
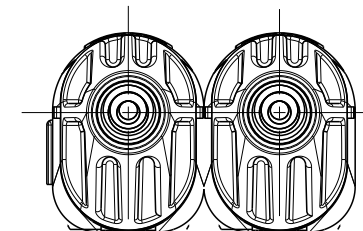
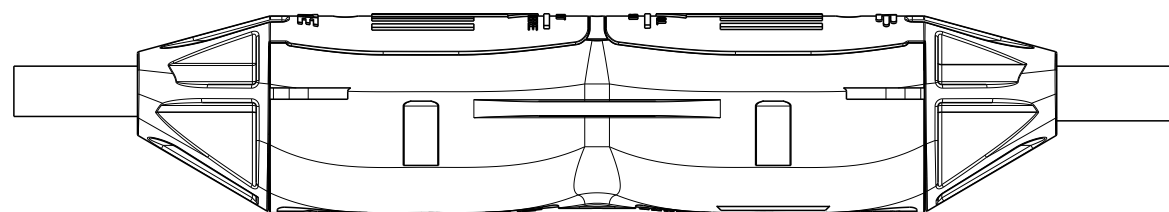
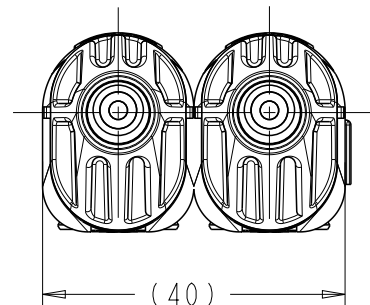
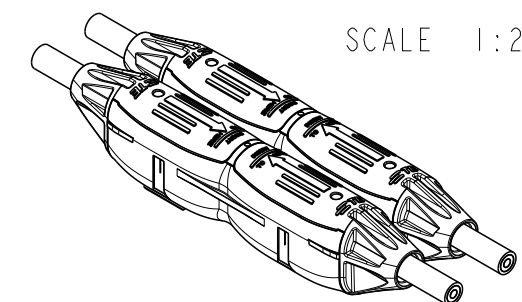
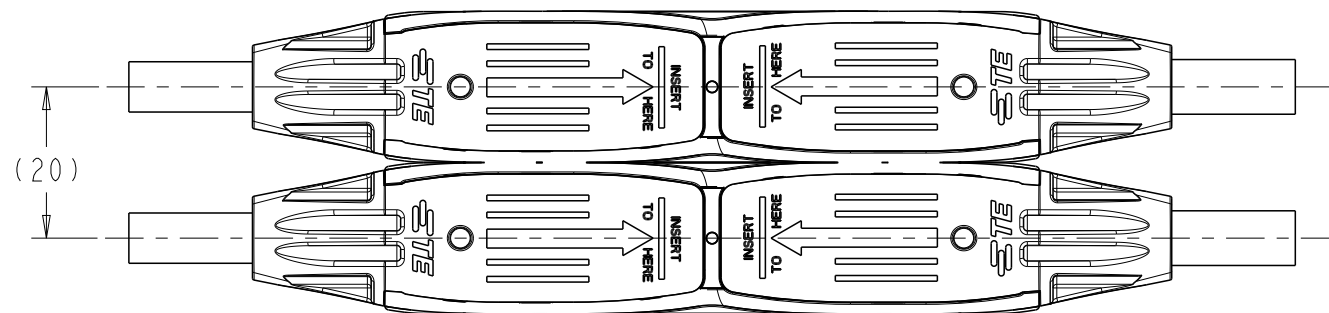

THIS DRAWING IS A CONTROLLED DOCUMENT.

DIMENSIONS: mm		TOLERANCES UNLESS OTHERWISE SPECIFIED:	
		0 PLC	±0.4
		1 PLC	±0.3
		2 PLC	±-
		3 PLC	±-
		4 PLC	±-
MATERIAL		ANGLES	±-
		FINISH	-

DWN	GANESH C M	29 JUN 2018
CHK	D FREDDY	29 JUN 2018
APVD	D FREDDY	29 JUN 2018
PRODUCT SPEC	108-133104	
APPLICATION SPEC	114-133104	
WEIGHT	-	
CUSTOMER DRAWING		



NAME SOLARLOK 2.0 - SPLICE			
SIZE	CAGE CODE	DRAWING NO	RESTRICTED TO
A3	00779	C-2336077	-
SCALE 1:1		SHEET 3 OF 3	REV B

Mouser Electronics

Authorized Distributor

Click to View Pricing, Inventory, Delivery & Lifecycle Information:

[TE Connectivity:](#)

[2336077-1](#)