

| LOC | DIST | REVISIONS | | | |
|-----|------|-----------|-----------|----|-----|
| | | REV | DATE | BY | CHK |
| | | A9 | 05SEP2016 | WW | RR |
| | | A10 | 16FEB2017 | LZ | RR |
| | | A11 | 03JUL2017 | LZ | RR |
| | | B | 30MAR2021 | KD | FL |

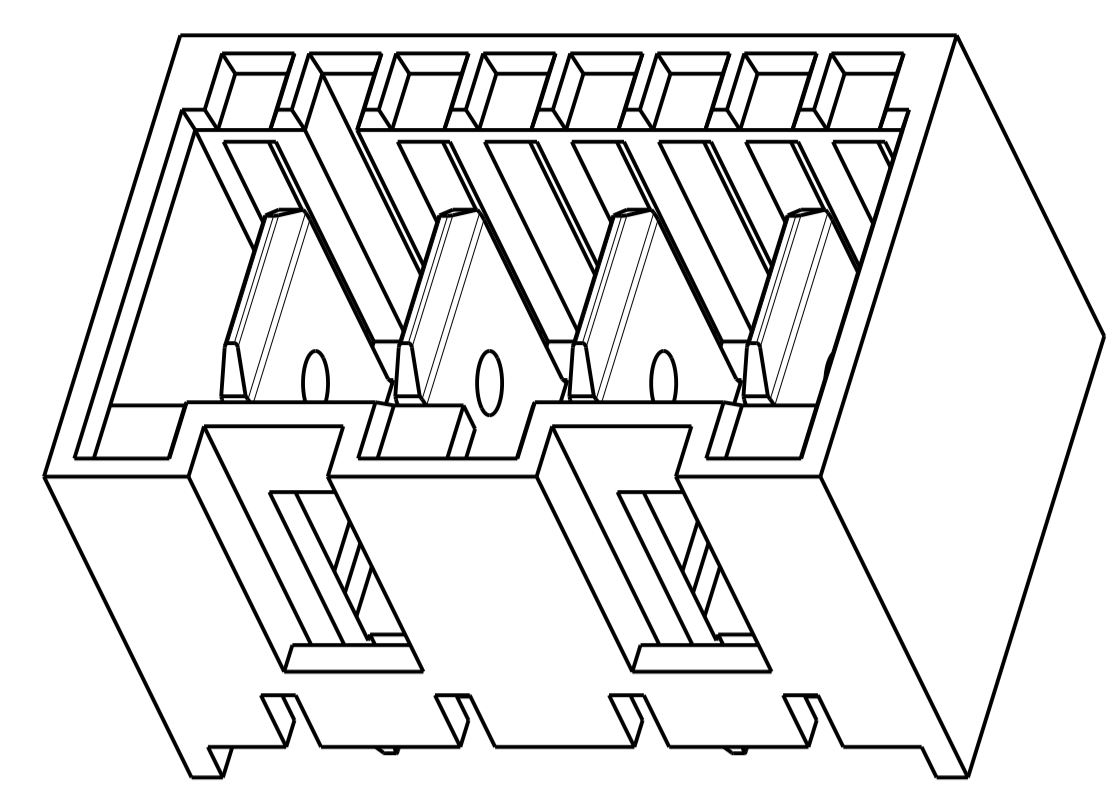

- NOTE**
- HOUSING HAS RAST 5 COMPLIANT KEYING, LATCHING, AND POLARIZATION TAB IS 6.30 X 0.8 ACCORDING TO DIN 46244
 - SEE SHEET 2 FOR AVAILABLE CONFIGURATIONS
 - MATERIAL: HOUSING, NYLON, UL94 V0, 750°C GWT NO FLAME CONTACT, COPPER ALLOY, 0.8MM THICK
 - FINISH: CONTACTS, MATT TIN PLATING OVERALL, NICKEL UNDER-PLATING BRIGHT TIN PLATING OVERALL, NICKEL UNDER-PLATING SILVER PLATING OVERALL, NICKEL UNDER-PLATING
 - PCB TABS INSERTED IN A STAGGERED PATTERN BEGINNING WITH POSITION 1 (Cct1)
 - THE PART NUMBERS SHOWING IN SHEET 2 & 3 & 4 & 5 ARE FOR NATURAL COLOR. THE PART NUMBER FOR OTHER COLOR ARE BASED ON THE NATURAL ONE: FOR THE SAME CONFIGURATION, THE PREFIX AND POSTFIX OF THE P/N ARE THE SAME, ONLY THE BASE NUMBER IS DIFFERENT ACCORDING TO DIFFERENT COLOR, DETAIL PLEASE SEE SHEET 6
 - PACKAGING: LOOSE PIECE OR TUBE. THE PART NUMBERS IN THIS DRAWING ARE WITH LOOSE PIECE PACKAGING. PLEASE CONTACT TE SALES REPRESENTATIVES FOR TUBE PACKAGING REQUIREMENT.
- PRELIMINARY PART NOT RELEASED FOR PRODUCTION
- FOR P/N: 8-2232043-7:
 1) THE CONTACTS ARE WITH BRIGHT TIN PLATING ACCORDING TO STANDARD: ASTM B 545.

- PART NUMBERS WITH TUBE PACKAGING
- PART WITHOUT POLARIZATION PEG STRUCTURE (FOR PN: 2316476-3)

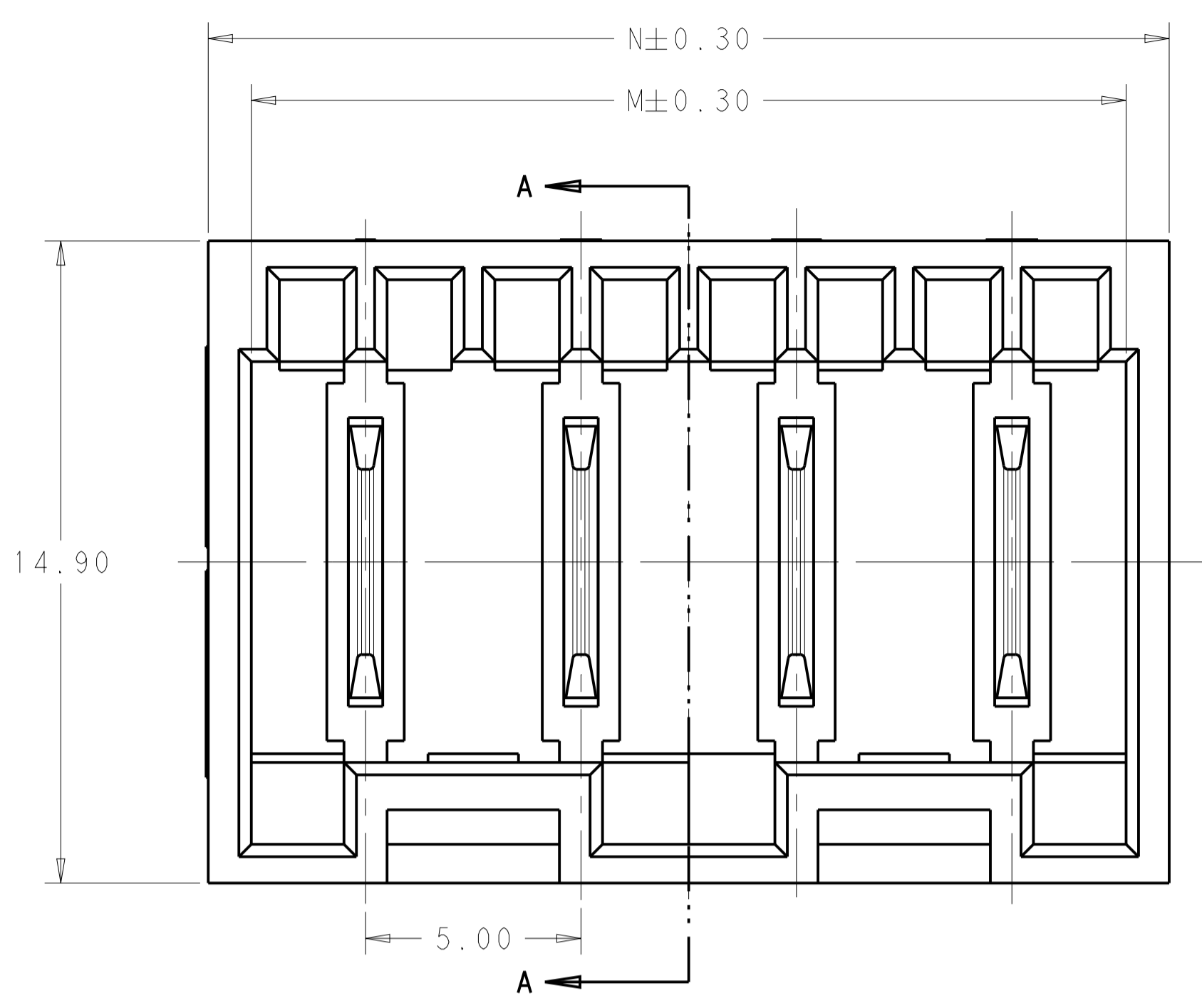
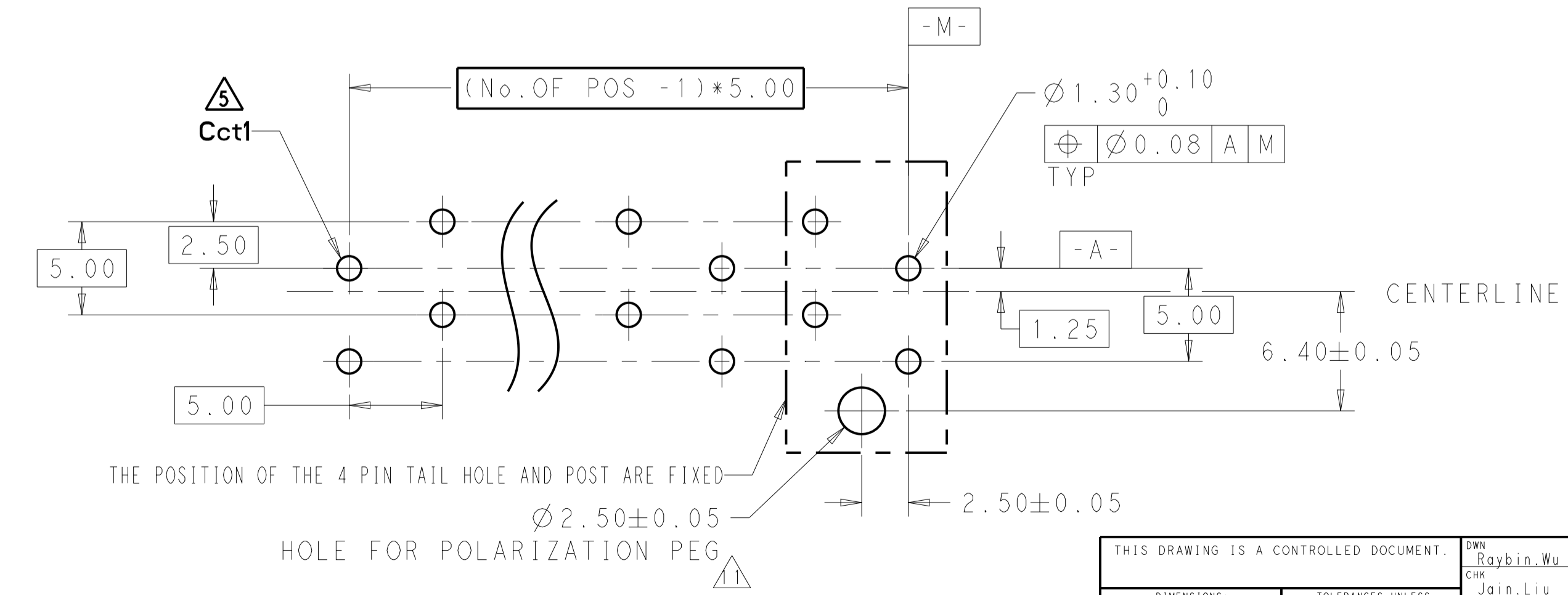
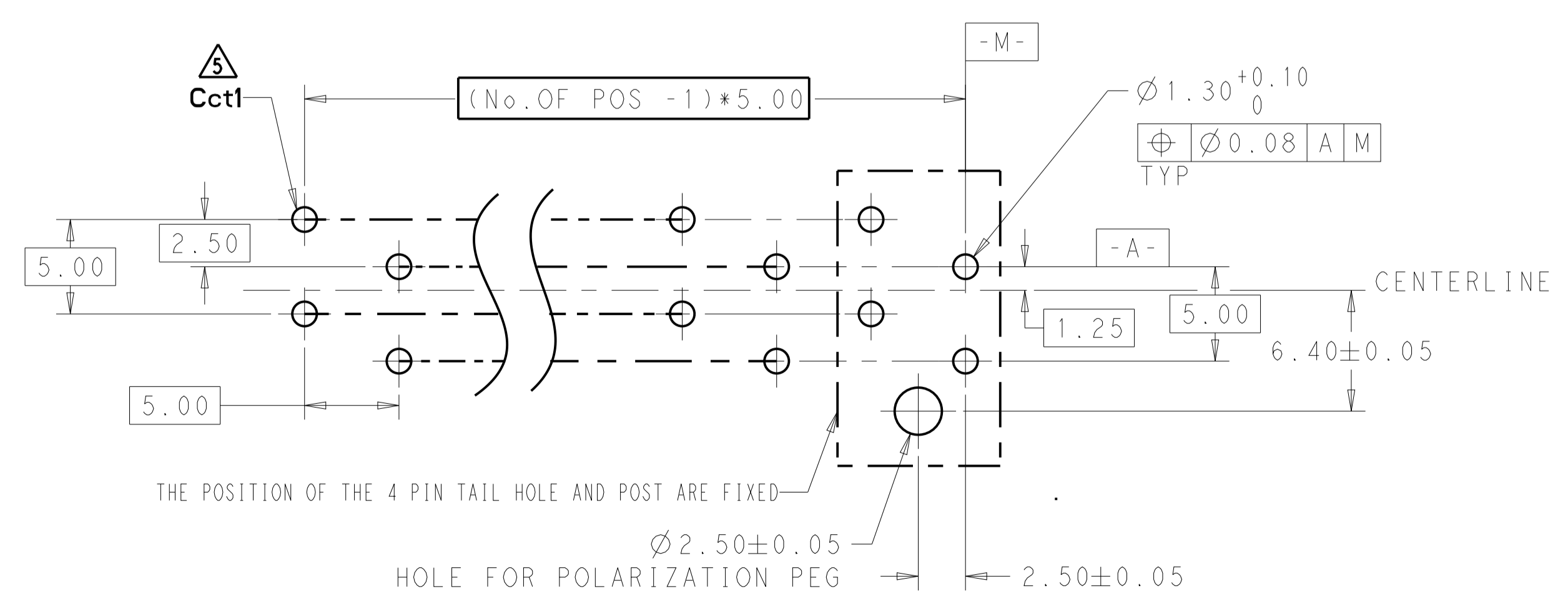
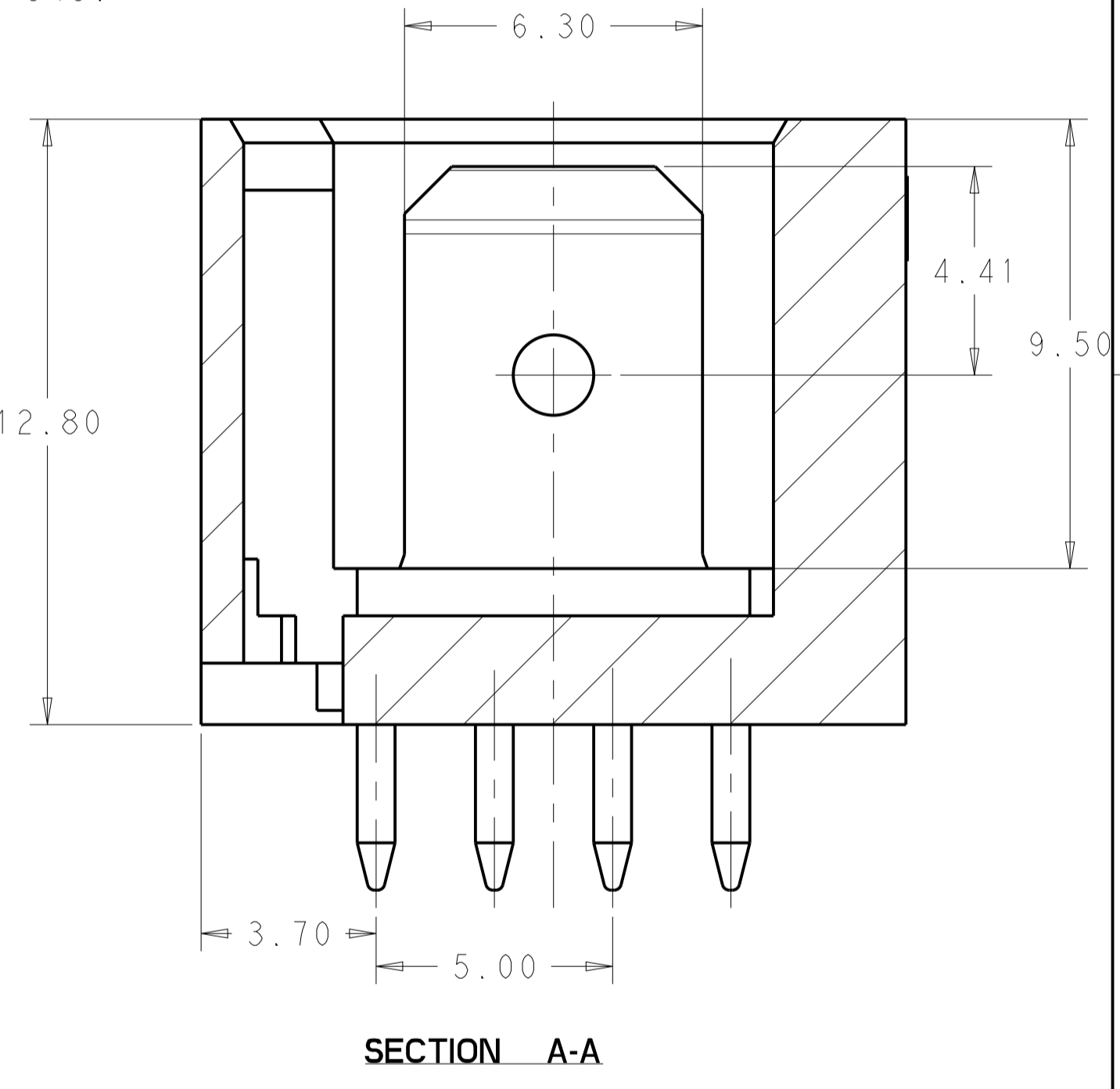
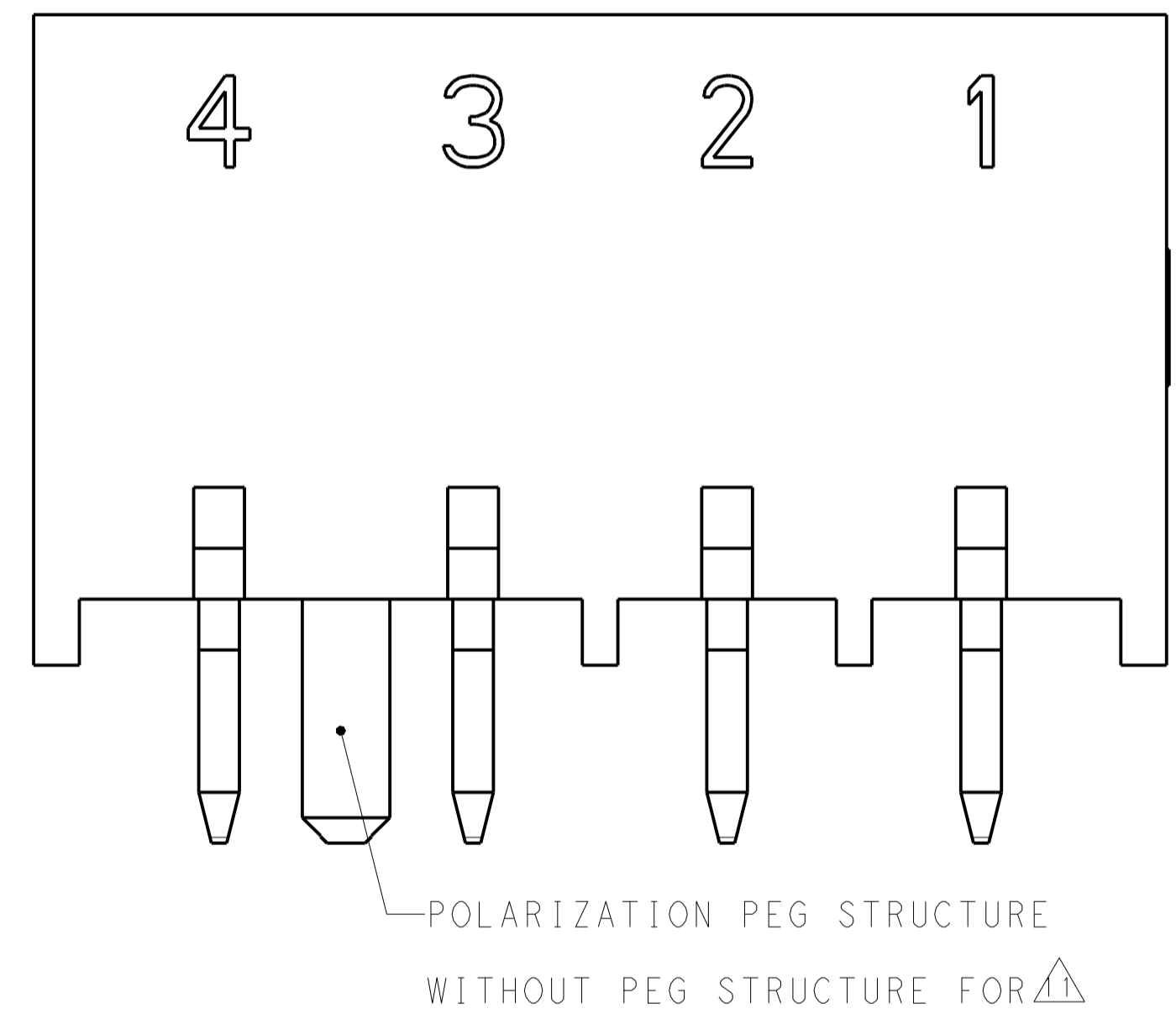
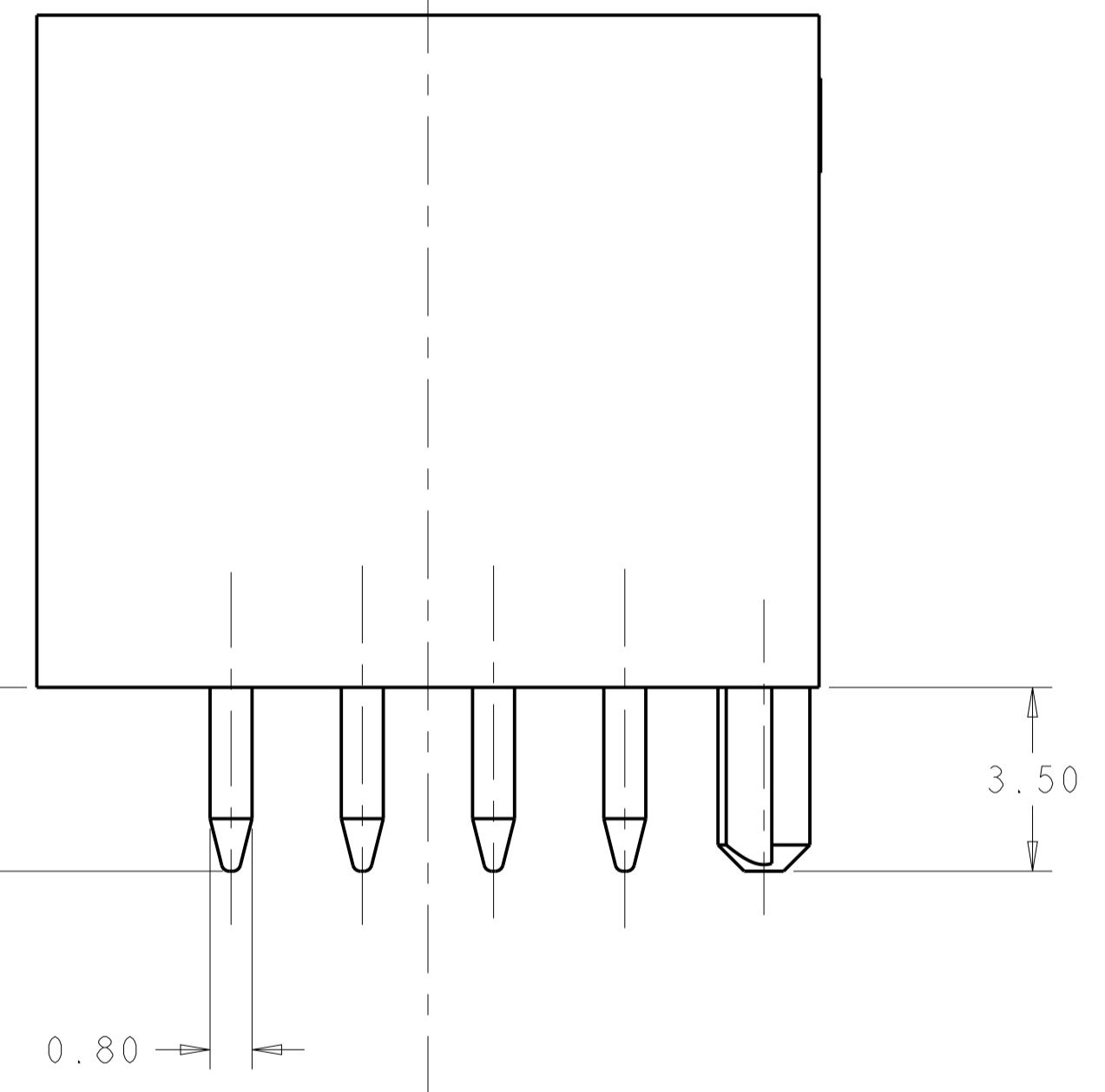
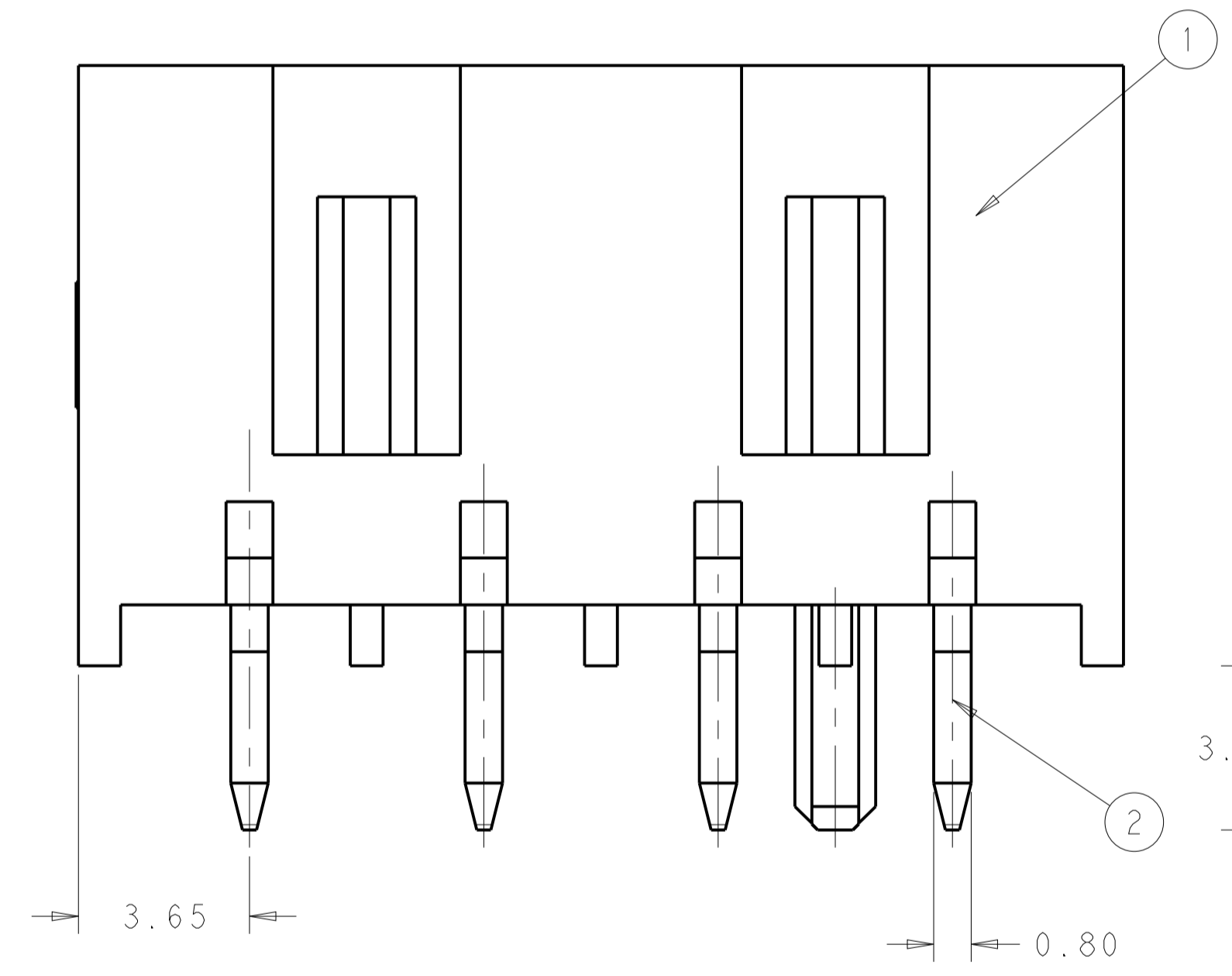

| | | |
|-------|-------|-------------|
| 42.30 | 40.30 | 8 |
| 37.30 | 35.30 | 7 |
| 32.30 | 30.30 | 6 |
| 27.30 | 25.30 | 5 |
| 22.30 | 20.30 | 4 |
| 17.30 | 15.30 | 3 |
| 12.30 | 10.30 | 2 |
| N | M | NO. OF POS. |

RECOMMEND PCB LAYOUT - SOLDER SIDE
 EVEN NUMBER OF PINS
 PCB 15±0.2 THICK

RECOMMEND PCB LAYOUT - SOLDER SIDE
 ODD NUMBER OF PINS
 PCB 15±0.2 THICK

THIS DRAWING IS A CONTROLLED DOCUMENT.

| | | | | | |
|--------------------------|-------------------|---|----------|--------------------|----------------|
| OWN: Raybin.Wu | 17Mar2014 | TE Connectivity RAST 5 TAB HEADER ASSY, OPPOSITE DIN STYLE, TH, VERTICAL | | | |
| CHK: Jain.Liu | 17Mar2014 | | | | |
| APVD: Robone.Riccardi | 17Mar2014 | | | | |
| PRODUCT SPEC: 108-106080 | APPLICATION SPEC: | | | | |
| MATERIAL: | FINISH: | WEIGHT: | SIZE: A1 | CAGE CODE: 2232043 | RESTRICTED TO: |
| Customer Drawing | | SCALE: 5:1 | SHEET: 1 | OF: 6 | REV: B |

| LOC | DIST | REV | DATE | BY | APPV |
|-----|------|-----|------|----|------|
| ES | 00 | | | | |
| | | | | | |
| | | | | | |
| | | | | | |

| QTY | ② | QTY | ① | NO. OF POS. | TE PART NO. |
|-----|--|-----|---|-------------|--|
| 8 | TAB CONTACT MATT TIN PLATING (8-2232043-7 IS WITH BRIGHT TIN) | 1 | RAST 5 TAB HEADER HOUSING, 8P, NATURE (SEE THE DETAIL LAYOUT ON SHEET 5) | 8 | 5-2232043-8 |
| | | | | | 4-2232043-8 |
| | | | | | 3-2232043-8 |
| | | | | | 2-2232043-8 |
| 7 | TAB CONTACT MATT TIN PLATING (8-2232043-7 IS WITH BRIGHT TIN) | 1 | RAST 5 TAB HEADER HOUSING, 7P, NATURE (SEE THE DETAIL LAYOUT ON SHEET 5) | 7 | 1-2232043-8 |
| | | | | | 2232043-8 |
| | | | | | 9-2232043-7 |
| | | | | | 8-2232043-7 |
| | | | | | 7-2232043-7 |
| | | | | | 6-2232043-7 |
| | | | | | 5-2232043-7 |
| | | | | | 4-2232043-7 |
| | | | | | 3-2232043-7 |
| | | | | | 2-2232043-7 |
| | | | | | 1-2232043-7 |
| 6 | | | | | TAB CONTACT MATT TIN PLATING (8-2232043-7 IS WITH BRIGHT TIN) |
| | 2232045-6 | | | | |
| | 9-2232043-6 | | | | |
| | 8-2232043-6 | | | | |
| | 7-2232043-6 | | | | |
| | 6-2232043-6 | | | | |
| | 5-2232043-6 | | | | |
| | 4-2232043-6 | | | | |
| | 3-2232043-6 | | | | |
| | 2-2232043-6 | | | | |
| | 1-2232043-6 | | | | |
| 5 | TAB CONTACT MATT TIN PLATING (8-2232043-7 IS WITH BRIGHT TIN) | 1 | RAST 5 TAB HEADER HOUSING, 5P, NATURE (SEE THE DETAIL LAYOUT ON SHEET 4) | 5 | |
| | | | | | 2232512-5 |
| | | | | | 9-2232043-5 |
| | | | | | 8-2232043-5 |
| | | | | | 7-2232043-5 |
| | | | | | 6-2232043-5 |
| | | | | | 5-2232043-5 |
| | | | | | 4-2232043-5 |
| | | | | | 3-2232043-5 |
| | | | | | 2-2232043-5 |
| | | | | | 1-2232043-5 |

| QTY | ② | QTY | ① | NO. OF POS. | TE PART NO. |
|-----|---------------------------------|-----|---|-------------|---------------------------------|
| 4 | TAB CONTACT MATT TIN PLATING | 1 | RAST 5 TAB HEADER HOUSING, 4P, NATURE (SEE THE DETAIL LAYOUT ON SHEET 4) | 4 | 5-2232045-4 |
| | | | | | 4-2232045-4 |
| | | | | | 3-2232045-4 |
| | | | | | 2-2232045-4 |
| | | | | | 2232045-4 |
| | | | | | 9-2232043-4 |
| | | | | | 8-2232043-4 |
| | | | | | 7-2232043-4 |
| | | | | | 6-2232043-4 |
| | | | | | 5-2232043-4 |
| | | | | | 4-2232043-4 |
| 3 | | | | | TAB CONTACT MATT TIN PLATING |
| | 2-2232043-4 | | | | |
| | 1-2232043-4 | | | | |
| | 2303420-4 | | | | |
| | 2232043-4 | | | | |
| | 5-2232045-3 | | | | |
| | 4-2232045-3 | | | | |
| | 3-2232045-3 | | | | |
| | 2-2232045-3 | | | | |
| | 1-2232045-3 | | | | |
| | 2232045-3 | | | | |
| 2 | TAB CONTACT MATT TIN PLATING | 1 | RAST 5 TAB HEADER HOUSING, 2P, NATURE (SEE THE DETAIL LAYOUT ON SHEET 4) | 2 | |
| | | | | | 8-2232043-3 |
| | | | | | 7-2232043-3 |
| | | | | | 6-2232043-3 |
| | | | | | 5-2232043-3 |
| | | | | | 4-2232043-3 |
| | | | | | 3-2232043-3 |
| | | | | | 2-2232043-3 |
| | | | | | 1-2232043-3 |
| | | | | | 2303420-3 |
| | | | | | 2232043-3 |

THIS DRAWING IS A CONTROLLED DOCUMENT.

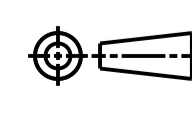
| | | | |
|---|---|---|--|
| DIMENSIONS: MEN  | TOLERANCES UNLESS OTHERWISE SPECIFIED: 0 PLC ± 1 PLC ±0.25 2 PLC ± 3 PLC ± 4 PLC ± ANGLES ±2° FINISH | CHECKED: HUIPING WU 30-Jan-13 DRAWN: HAPYE WU 30-Jan-13 APVD: YIM 30-Jan-13 PRODUCT SPEC APPLICATION SPEC WEIGHT CUSTOMER DRAWING | NAME: RAST 5 TAB HEADER ASSY, OPPOSITE DIN STYLE, TH, VERTICAL SIZE: A1 CAGE CODE: 00779 DRAWING NO: 2232043 SCALE: N/A SHEET: 2 OF 6 REV: B |
|---|---|---|--|

4805 (3/11)

| LOC | DIST | REV | DATE | BY | APPV |
|-----|------|-----|------|----|------|
| ES | 00 | | | | |

| REVISIONS | | | |
|-----------|------|-------------|----|
| NO. | DATE | DESCRIPTION | BY |
| - | - | SEE SHEET 1 | - |

| | | | | | |
|-----|------------------------------|-----|--|-------------|-------------|
| 3 | TAB CONTACT W/SILVER PLATING | 1 | RAST 5 TAB HEADER HOUSING, 3P, NATURE (SEE THE DETAIL LAYOUT ON SHEET 4) | 3 | 2316476-3 |
| QTY | ② | QTY | ① | NO. OF POS. | TE PART NO. |

| | | | | | |
|-----|-------------------------------|-----|--|-------------|-------------|
| 8 | TAB CONTACT W/ SILVER PLATING | 1 | RAST 5 TAB HEADER HOUSING, 8P, NATURE (SEE THE DETAIL LAYOUT ON SHEET 5) | 8 | 5-2232044-8 |
| | | | | | 4-2232044-8 |
| 7 | TAB CONTACT W/ SILVER PLATING | 1 | RAST 5 TAB HEADER HOUSING, 7P, NATURE (SEE THE DETAIL LAYOUT ON SHEET 5) | 7 | 9-2232044-7 |
| | | | | | 8-2232044-7 |
| 6 | TAB CONTACT W/ SILVER PLATING | 1 | RAST 5 TAB HEADER HOUSING, 6P, NATURE (SEE THE DETAIL LAYOUT ON SHEET 5) | 6 | 7-2232044-6 |
| | | | | | 8-2232044-6 |
| 5 | TAB CONTACT W/ SILVER PLATING | 1 | RAST 5 TAB HEADER HOUSING, 5P, NATURE (SEE THE DETAIL LAYOUT ON SHEET 4) | 5 | 9-2232044-5 |
| | | | | | 8-2232044-5 |
| QTY | ② | QTY | ① | NO. OF POS. | TE PART NO. |

| | | | | | |
|-----|-------------------------------|-----|--|-------------|-------------|
| 4 | TAB CONTACT W/ SILVER PLATING | 1 | RAST 5 TAB HEADER HOUSING, 4P, NATURE (SEE THE DETAIL LAYOUT ON SHEET 4) | 4 | 5-2232046-4 |
| | | | | | 4-2232046-4 |
| 3 | TAB CONTACT W/ SILVER PLATING | 1 | RAST 5 TAB HEADER HOUSING, 3P, NATURE (SEE THE DETAIL LAYOUT ON SHEET 4) | 3 | 4-2232046-3 |
| | | | | | 3-2232046-3 |
| 2 | TAB CONTACT W/ SILVER PLATING | 1 | RAST 5 TAB HEADER HOUSING, 2P, NATURE (SEE THE DETAIL LAYOUT ON SHEET 4) | 2 | 4-2232046-2 |
| | | | | | 3-2232046-2 |
| QTY | ② | QTY | ① | NO. OF POS. | TE PART NO. |

THIS DRAWING IS A CONTROLLED DOCUMENT.

| | | | | |
|-------------|--|-------------------|------------------|--|
| DIMENSIONS: | TOLERANCES UNLESS OTHERWISE SPECIFIED: | OWN: EQUIPING, WU | CHK: HAPYE WU | 30-Jan-13 |
| MEN | 0 PLC ± | APVD: HAPYE WU | 30-Jan-13 | NAME: RAST 5 TAB HEADER ASSY, OPPOSITE DIN STYLE, TH, VERTICAL |
| | 1 PLC ±0.25 | PRODUCT SPEC | | |
| | 2 PLC ± | APPLICATION SPEC | | |
| | 3 PLC ± | SIZE: A1 | CAGE CODE: 00779 | DRAWING NO: 2232043 |
| | 4 PLC ± | RESTRICTED TO: | | |
| | ANGLES ± | CUSTOMER DRAWING | SCALE: N/A | SHEET: 3 OF 6 |
| MATERIAL: | FINISH: | WEIGHT: | | REV: B |

| LOC | DIST | REV | DATE | BY | APPV |
|-----|------|-----|------|----|------|
| ES | 00 | | | | |

| REVISIONS | | | | |
|-----------|------|----|------|-------------|
| REV | DATE | BY | APPV | DESCRIPTION |
| - | - | - | - | SEE SHEET 1 |

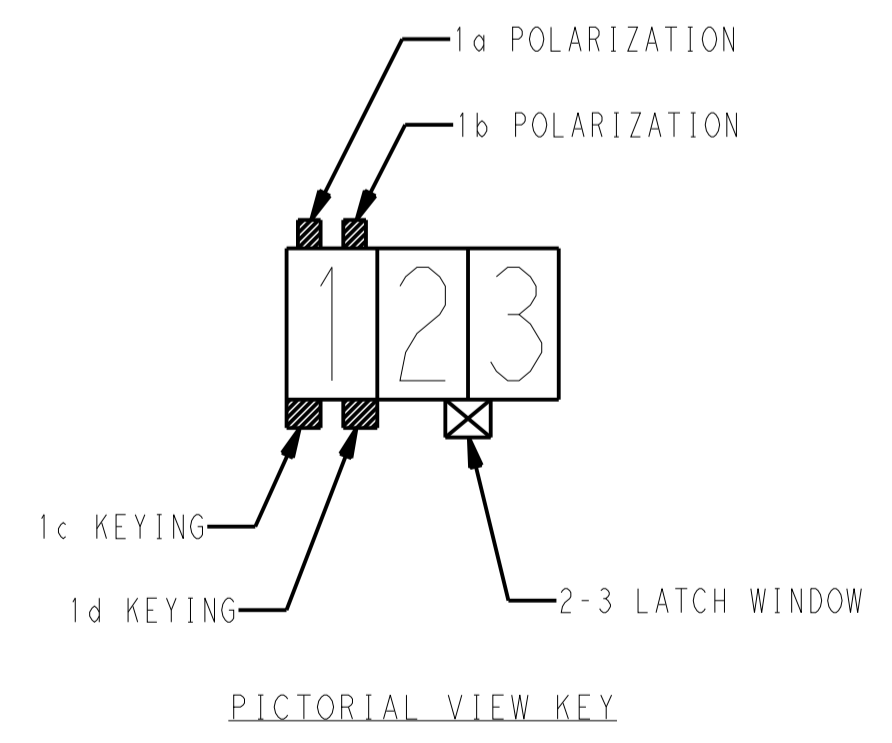

| | | | | |
|--|--|-------------------|-----------|--|
| THIS DRAWING IS A CONTROLLED DOCUMENT. | | OWN RUIPING WU | 30-Jan-13 | |
| DIMENSIONS: | | CHK HAPYE WU | 30-Jan-13 | |
| TOLERANCES UNLESS OTHERWISE SPECIFIED: | | APVD YIM | 30-Jan-13 | NAME RAST 5 TAB HEADER ASSY, OPPOSITE DIN STYLE, TH, VERTICAL |
| MIN | | PRODUCT SPEC | | |
| 0 PLC ± | | APPLICATION SPEC | | SIZE A1 |
| 1 PLC ± | | SCALE | N/A | |
| 2 PLC ±0.25 | | RESTRICTED TO | | SHEET 4 OF 6 REV B |
| 3 PLC ± | | | | |
| 4 PLC ± | | | | |
| ANGLES ± | | | | |
| FINISH | | | | |
| MATERIAL | | | | |
| CUSTOMER DRAWING | | | | |

| LOC | DIST | REV | DATE | BY | APPV | DESCRIPTION |
|-----|------|-----|------|----|------|-------------|
| ES | 00 | | | | | SEE SHEET 1 |
| | | | | | | |
| | | | | | | |

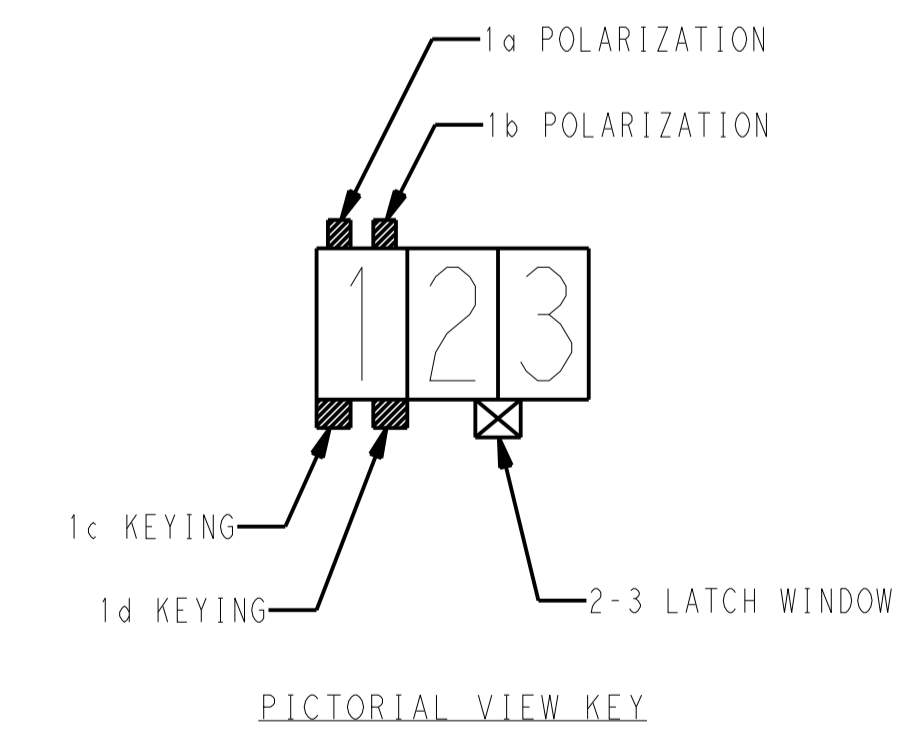
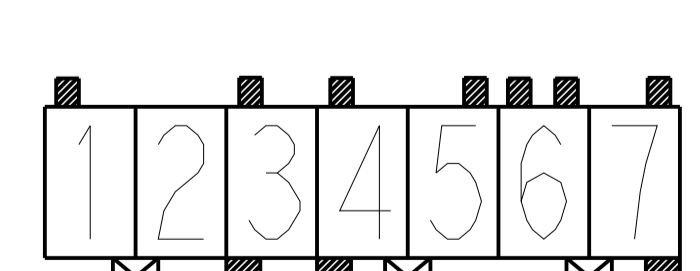
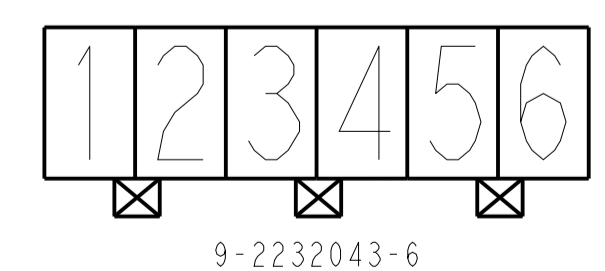
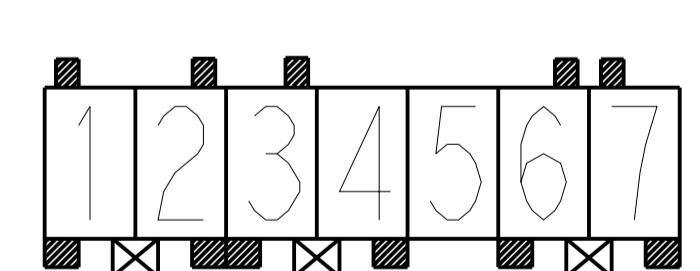
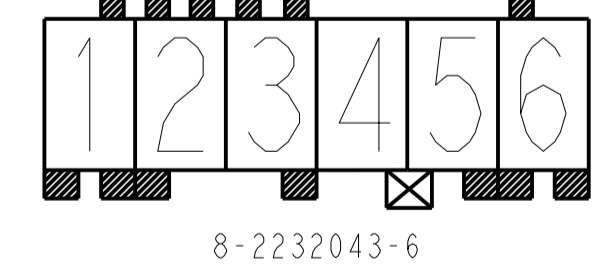
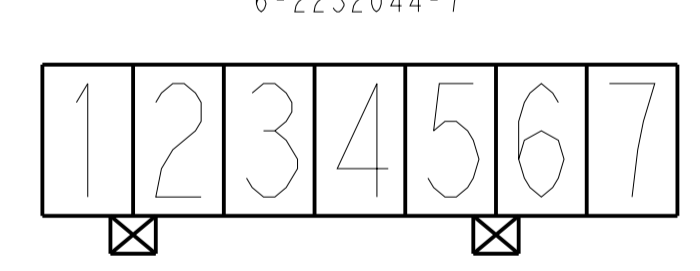
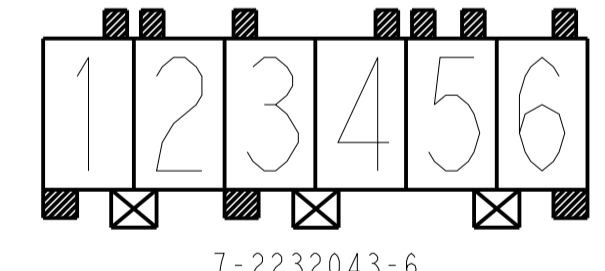
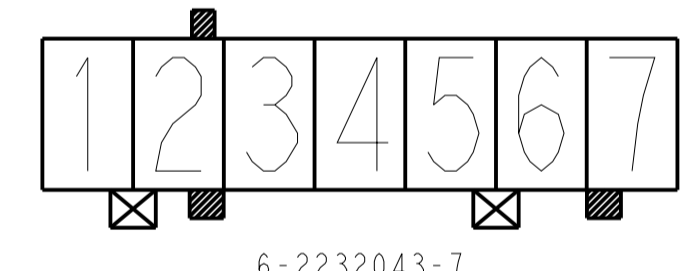
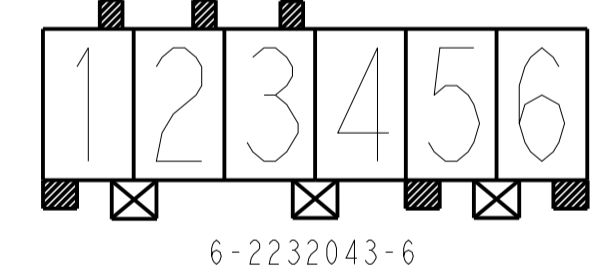
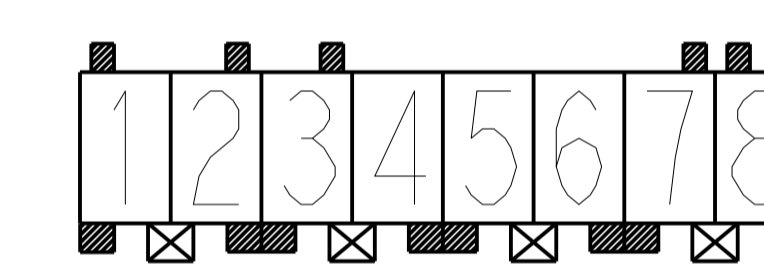
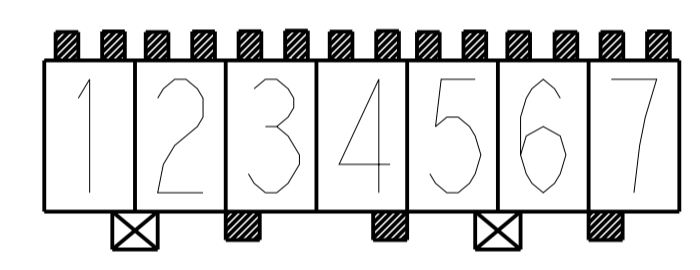
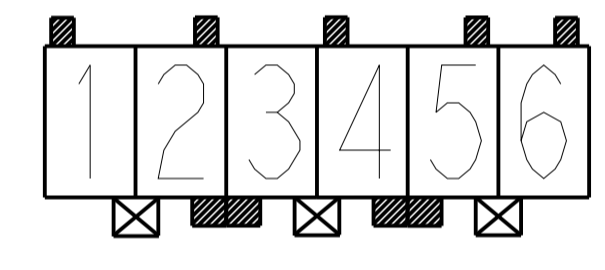
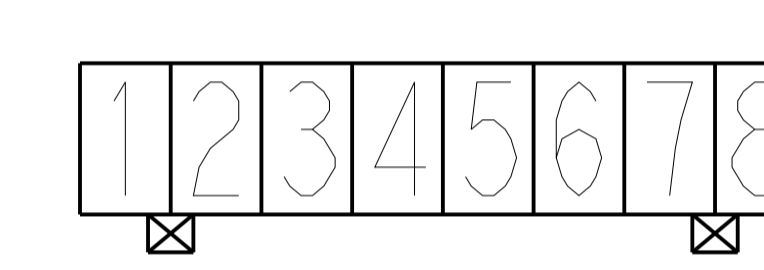
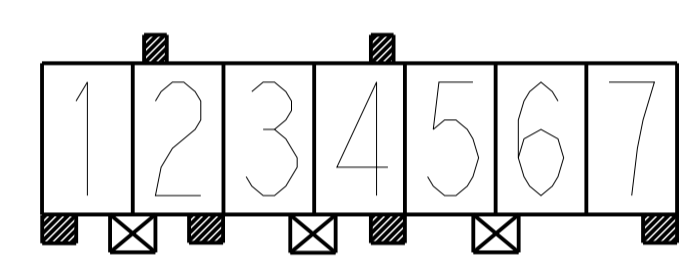
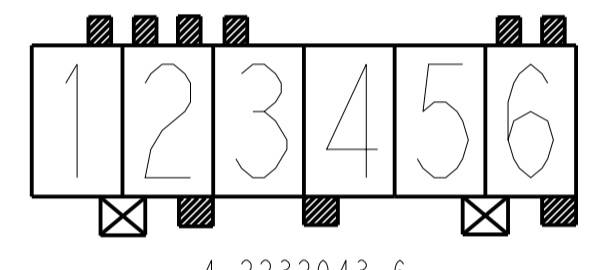
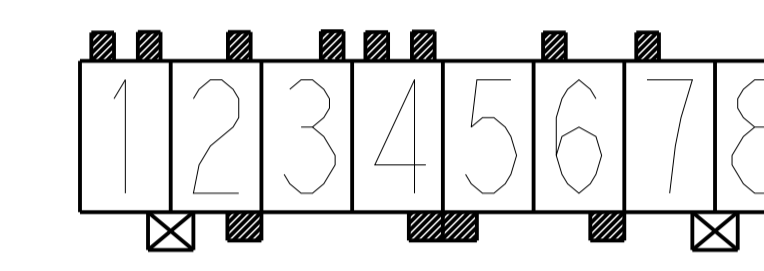
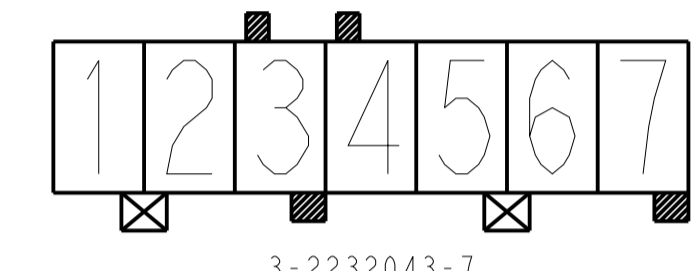
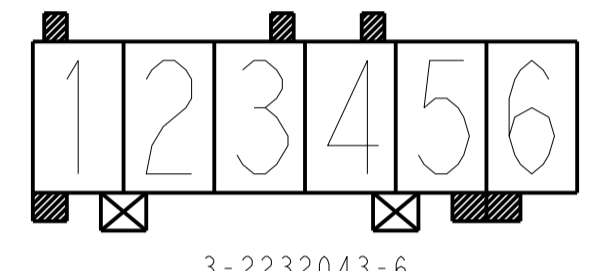
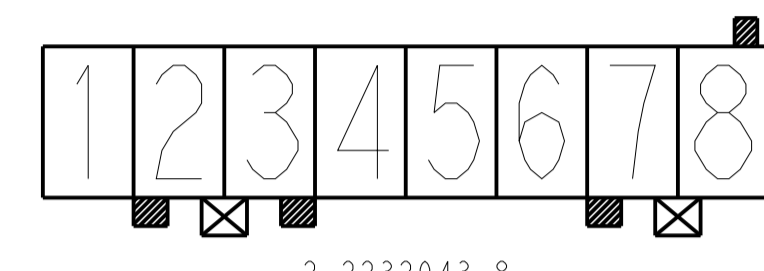
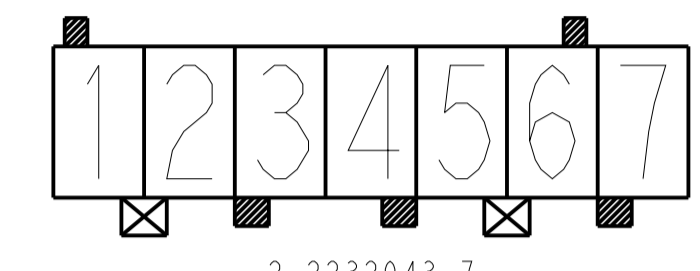
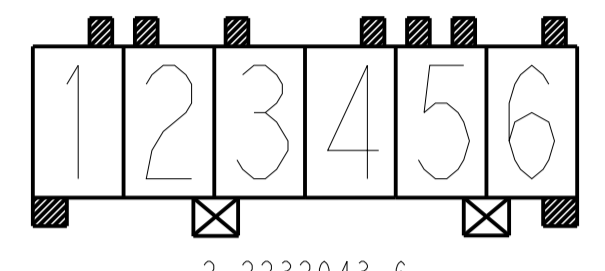
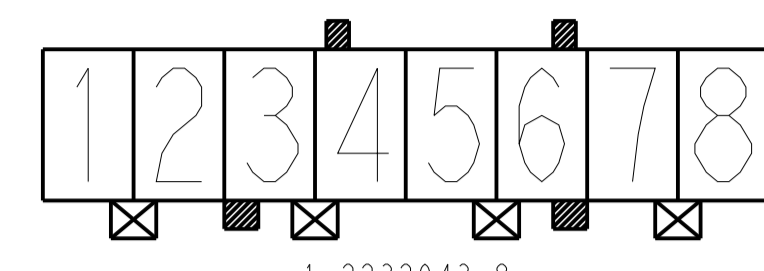
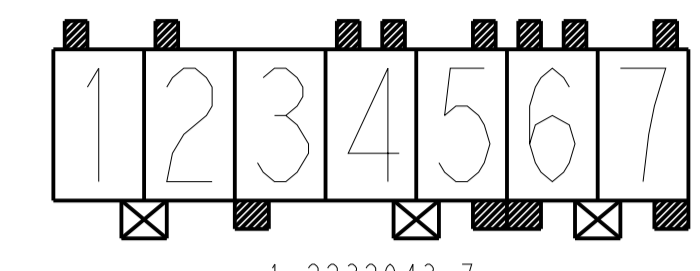
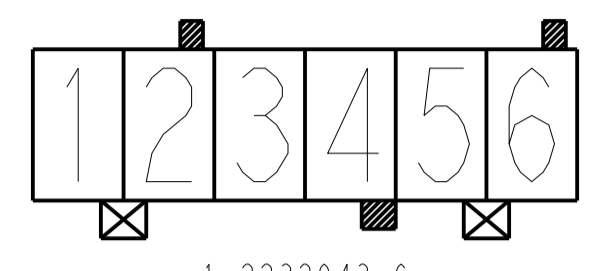
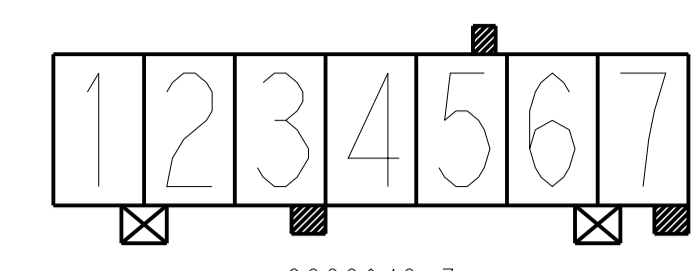
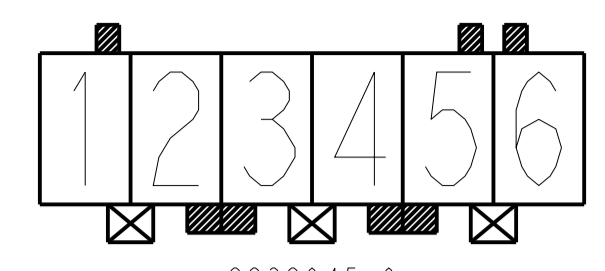
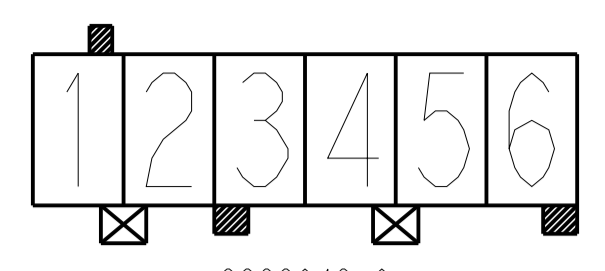

| | | | |
|--|--|---------------------------|--|
| THIS DRAWING IS A CONTROLLED DOCUMENT. | | OWN: RUIPING WU 30-Jan-13 | TE Connectivity |
| DIMENSIONS: mm | | CHK: HAPYE WU 30-Jan-13 | |
| TOLERANCES UNLESS OTHERWISE SPECIFIED: | | APVD: YIHM 30-Jan-13 | NAME: RAST 5 TAB HEADER ASSY, OPPOSITE DIN STYLE, TH, VERTICAL |
| 0 PLC ± | | PRODUCT SPEC | |
| 1 PLC ±0.25 | | APPLICATION SPEC | SIZE: A1 |
| 2 PLC ± | | FINISH: ±0.2° | CAGE CODE: 00779 |
| 3 PLC ± | | WEIGHT | DRAWING NO: 2232043 |
| 4 PLC ± | | CUSTOMER DRAWING | SCALE: N/A |
| ANGLES ± | | RESTRICTED TO | SHEET 5 OF 6 |
| MATERIAL | | REV: B | |

| LOC | | DIST | | REVISIONS | | | |
|-----|--|------|--|-----------|------|----|------|
| | | | | REV | DATE | BY | APPV |
| | | | | | | | |
| | | | | | | | |
| | | | | | | | |

FOR ANY KEYING CONFIGURATION, THERE ARE EIGHT COLORS AVAILABLE. BESIDES THE NATURAL COLOR, THERE ARE OTHER SEVEN COLORS, INCLUDE: YELLOW, BLUE, GREY, PURPLE, RED, GREEN, BLACK. THE WHITE VERSION IS PRELIMINARY. THE P/N OF THE COLOR CONNECTOR ARE BASED ON THE NATURAL CONNECTOR. THE PREFIX AND POSTFIX ARE THE SAME FOR THE SAME KEYING CONFIGURATION, BUT THE BASE NUMBERS ARE DIFFERENT ACCORDING TO DIFFERENT COLOR. THE FOLLOWING SHOWS WHAT'S THE P/N FOR COLOR CONNECTOR

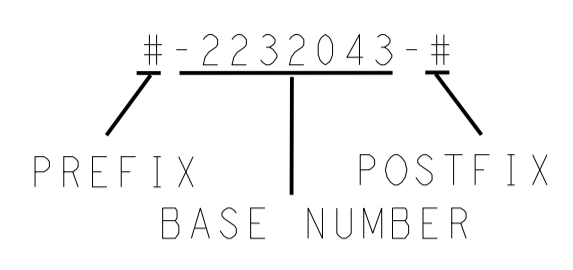

| COLOR | PART NUMBER OF THE CONNECTOR | | | | COMMENTS |
|---------|---|-------------|-------------------------|-------------|---|
| | WITH MATT TIN PLATING CONTACT (SPECIAL P/N: 8-2232043-7 ARE WITH BRIGHT TIN) | | WITH AG PLATING CONTACT | | |
| NATURAL | #-2232043-# 9 | #-2232045-# | #-2232044-# | #-2232046-# | THE DETAIL P/N FOR DIFFERENT KEYING SEE SHEET 2-5 |
| RED | #-2232055-# | #-2232057-# | #-2232056-# | #-2232058-# | THE PREFIX AND POSTFIX ARE THE SAME WITH THE P/N OF THE NATURAL CONNECTOR FOR THE SAME KEYING CONFIGURATION, JUST THE BASE NUMBERS ARE DIFFERENT BASED ON DIFFERENT COLOR. # CAN BE THE NUMBER FROM 0 TO 9. |
| BLUE | #-2232047-# | #-2232049-# | #-2232048-# | #-2232050-# | |
| YELLOW | #-2232063-# | #-2232065-# | #-2232064-# | #-2232066-# | |
| BALCK | #-2232059-# | #-2232061-# | #-2232060-# | #-2232062-# | |
| GREY | #-2232067-# | #-2232069-# | #-2232068-# | #-2232070-# | |
| GREEN | #-2232051-# | #-2232053-# | #-2232052-# | #-2232054-# | |
| PURPLE | #-2232071-# | #-2232073-# | #-2232072-# | #-2232074-# | |
| WHITE | #-2232298-# | #-2232300-# | #-2232299-# | #-2232301-# | |

| COLOR | PART NUMBER OF THE CONNECTOR | | COMMENTS |
|---------|------------------------------|-------------|--|
| | WITH BRIGHT PLATING CONTACT | | |
| NATURAL | #-2232924-# | #-2232925-# | THE KEYING, POLARIZATION AND LATCH WINDOW CONFIGURATION ARE SAME AS THE MATT TIN CONNECTOR WITH THE SAME PREFIX AND POSTFIX FOR EACH COLOR. FOR EXAMPLE: 2232924-4 AND 2232043-4 HAVE SAME KEYING, POLARIZATION AND LATCH WINDOW CONFIGURATION. 2232925-4 AND 2232045-4 HAVE SAME KEYING, POLARIZATION AND LATCH WINDOW CONFIGURATION. THE DETAIL KEYING, POLARIZATION AND LATCH WINDOW CONFIGURATION FOR EACH P/N, PLEASE SEE SHEET 2-5 |
| RED | #-2232926-# | #-2232927-# | |
| BLUE | #-2232928-# | #-2232929-# | |
| YELLOW | #-2232930-# | #-2232931-# | |
| BALCK | #-2232932-# | #-2232933-# | |
| GREY | #-2232934-# | #-2232935-# | |
| GREEN | #-2232936-# | #-2232937-# | |
| PURPLE | #-2232938-# | #-2232939-# | |
| WHITE | #-2232940-# | #-2232941-# | |

FOR EXAMPLE, IF A CONNECTOR WITH THE CONFIGURATION AS BELOW, AND WITH TIN PLATING CONTACT, IN THE SHEET 4, WE CAN FIND THE RELATED CONNECTOR P/N WITH NATURAL COLOR IS 1-2232043-4, THEN WE CAN LOOK IN THE ABOVE TABLE TO FIND THE CONNECTOR P/N WITH RED COLOR IS 1-2232055-4

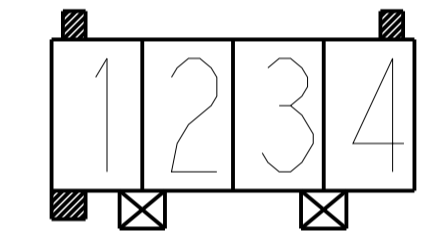

1-2232043-4

FOR ANOTHER EXAMPLE, IF A CONNECTOR WITH THE CONFIGURATION AS BELOW, AND WITH TIN PLATING CONTACT, IN THE SHEET 4, WE CAN FIND THE RELATED CONNECTOR P/N WITH NATURAL COLOR IS 1-2232045-4, THEN WE CAN LOOK IN THE ABOVE TABLE TO FIND THE CONNECTOR P/N WITH RED COLOR IS 1-2232057-4

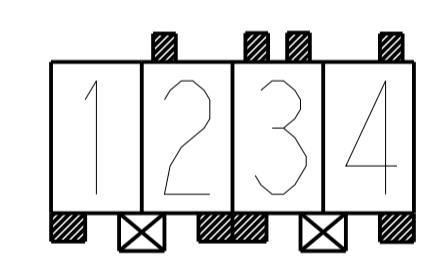

1-2232045-4

| | | | |
|--|-------------|--------------------------------|--|
| THIS DRAWING IS A CONTROLLED DOCUMENT. | | OWN RUIPING_WU 08-Apr-21 | TE Connectivity NAME RAST 5 TAB HEADER ASSY, OPPOSITE DIN STYLE, TH, VERTICAL |
| DIMENSIONS: | | CHK HAPYE_WU 08-Apr-21 | |
| TOLERANCES UNLESS OTHERWISE SPECIFIED: | | APVD YUAM 08-Apr-21 | |
| mm | 0 PLC ±- | PRODUCT SPEC | SIZE CAGE CODE DRAWING NO RESTRICTED TO |
| | 1 PLC ±- | 108-106080 | |
| | 2 PLC ±0.25 | APPLICATION SPEC | A100779C=2232043 SCALE 5:1 SHEET 6 OF 6 REV B |
| | 3 PLC ±- | | |
| | 4 PLC ±- | | |
| | ANGLES ±° | | |
| MATERIAL | FINISH | WEIGHT | Customer Drawing |

Mouser Electronics

Authorized Distributor

Click to View Pricing, Inventory, Delivery & Lifecycle Information:

[TE Connectivity:](#)

[3-2232045-3](#)